

500mA, 60V, 350kHz Synchronous Step-Down Converter

General Description

The RT6204 is a 60V, 500mA, 350kHz, high-efficiency, synchronous step-down DC-DC converter with an input-voltage range of 5.2V to 60V and a programmable output-voltage range of 0.8V to 50V. It features current-mode control to simplify external compensation and to optimize transient response with a wide range of inductors and output capacitors. High efficiency can be achieved through integrated N-MOSFETs, and pulse-skipping mode at light loads. With EN pin, power-up sequence can be more flexible and shutdown quiescent current can be reduced to $< 3\mu\text{A}$.

The RT6204 features cycle-by-cycle current limit for over-current protection against short-circuit outputs, and user-programmable soft-start time to prevent inrush current during startup. It also includes input under-voltage lockout, output under-voltage, and thermal shutdown protection to provide safe and smooth operation in all operating conditions.

The RT6204 is available in the SOP-8 (Exposed pad) package.

Features

- **0.8V Feedback Reference Voltage with $\pm 1.5\%$ Accuracy**
- **Wide Input Voltage Range : 5.2V to 60V**
- **Output Current : 500mA**
- **Integrated N-MOSFETs**
- **Current-Mode Control**
- **Fixed Switching Frequency : 350kHz**
- **Programmable Output Voltage : 0.8V to 50V**
- **Low $< 3\mu\text{A}$ Shutdown Quiescent Current**
- **Up to 92% Efficiency**
- **Pulse-Skipping Mode for Light-Load Efficiency**
- **Programmable Soft-Start Time**
- **Cycle-by-Cycle Current Limit Protection**
- **Input Under-Voltage Lockout, Output Under-Voltage and Thermal Shutdown Protection**

Applications

- 4-20mA Loop-Powered Sensors
- OBD-II Port Power Supplies
- Low-Power Standby or Bias Voltage Supplies
- Industrial Process Control, Metering, and Security Systems
- High-Voltage LDO Replacement
- Telecommunications Systems
- Commercial Vehicle Power Supplies
- General Purpose Wide Input Voltage Regulation

Simplified Application Circuit

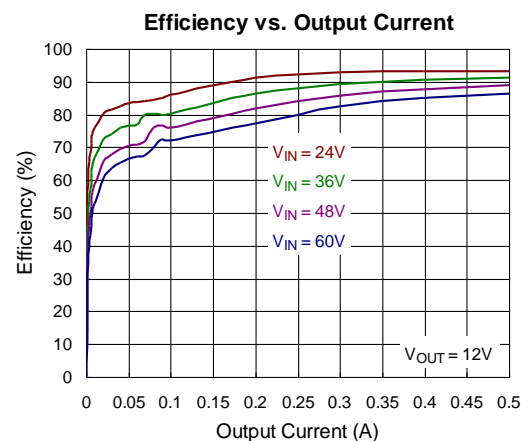
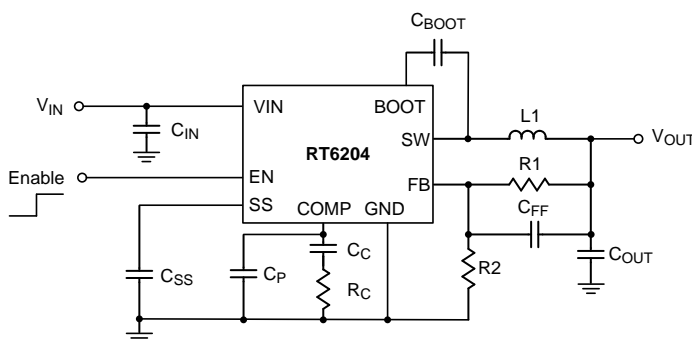

Ordering Information

RT6204 □□

- Package Type
SP : SOP-8 (Exposed Pad-Option 2)
- Lead Plating System
G : Green (Halogen Free and Pb Free)

Note :

Richtek products are :

- ▶ RoHS compliant and compatible with the current requirements of IPC/JEDEC J-STD-020.
- ▶ Suitable for use in SnPb or Pb-free soldering processes.

Marking Information

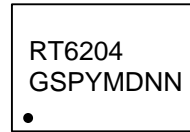

RT6204GSP : Product Number
YMDNN : Date Code

Pin Configuration

(TOP VIEW)

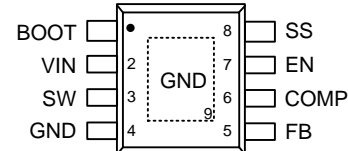

SOP-8 (Exposed Pad)

Functional Pin Description

Pin No.	Pin Name	Pin Function
1	BOOT	Bootstrap capacitor connection node for High-Side Gate Driver. Connect a 0.1μF ceramic capacitor from BOOT to SW to power the internal gate driver.
2	VIN	Supply voltage input, 5.2V to 60V. Bypass VIN to GND with a large high-quality capacitor.
3	SW	Switch node for output inductor connection.
4, 9 (Exposed Pad)	GND	Power ground. The exposed pad must be connected to GND and well soldered to the input and output capacitors and a large PCB copper area for maximum power dissipation.
5	FB	Feedback voltage input. Connect FB to the midpoint of the external feedback resistor divider to sense the output voltage. The device regulates the FB voltage at 0.8V (typical) Feedback Reference Voltage.
6	COMP	Compensation node for the compensation of the regulation control loop. Connect a series RC network from COMP to GND. In some cases, another capacitor from COMP to GND may be required.
7	EN	Enable control input. A logic High ($V_{EN} > 1.35V$) enables the device, and a logic Low ($V_{EN} < 0.925V$) shuts down the device, reducing the supply current to 3μA or below. Connect EN pin to VIN pin with a 100kΩ pull-up resistor for automatic startup.
8	SS	Soft-start capacitor connection node. Connect an external capacitor from SS to GND to set the soft-start time. Do not leave SS pin unconnected. A capacitor of capacitance from 10nF to 100nF is recommended, which can set the soft-start time from 1.33ms to 13.3ms, accordingly.

Functional Block Diagram

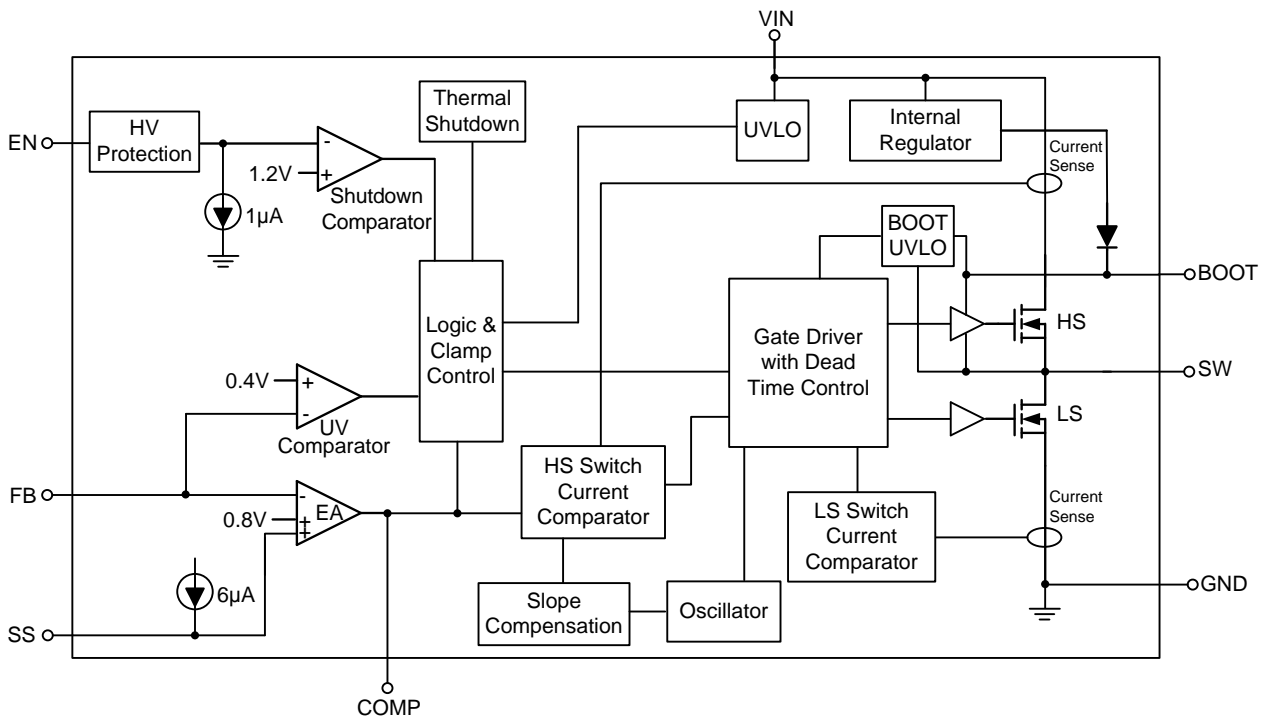

Operation

The RT6204 is a synchronous step-down converter, integrated with both high-side (HS) and low-side (LS) MOSFETs to reduce external component count and a gate driver with dead-time control logic to prevent shoot-through condition from happening. The RT6204 also features constant frequency and peak current-mode control with slope compensation. During PWM operation, output voltage is regulated down, and is sensed from the FB pin to be compared with an internal 0.8V reference voltage V_{REF} . In normal operation, the high-side N-MOSFET is turned on when an S-R latch is set by the rising edge of an internal oscillator output as the PWM clock, and is turned off when the S-R latch is reset by the output of a (high-side) current comparator, which compares the high-side sensed current signal with the current signal related to the COMP voltage. While the high-side N-MOSFET is turned off, the low-side N-MOSFET will be turned on. If the output voltage is not established, the high-side power switch will be turned on again and another cycle begins.

Pulse Skipping Operation

At very light-load condition, the RT6204 provides pulse skipping technique to decrease switching loss for better efficiency. When load current decreases, the FB voltage V_{FB} will increase slightly. With V_{FB} 1% higher than V_{REF} , the COMP voltage will be clamped at a minimum value and the converter will enter into pulse skipping mode. When the converter operates in pulse skipping mode, the internal oscillator will be stopped, which makes the switching period being extended. In pulse skipping mode, as the load current decreases, V_{FB} will be discharged more slowly, which in turn will extend the switching period even more.

Error Amplifier

The RT6204 adopts a transconductance amplifier as the error amplifier. The error amplifier of a typical $970\mu A/V$ transconductance (g_m) compares the feedback voltage V_{FB} with the lower one of the soft-start voltage or the internal reference voltage V_{REF} , 0.8V. As V_{FB} drops due to the load current increase, the output voltage of the error amplifier will go up so

that the device will supply more inductor current to match the load current. The frequency compensation components, such as the series resistor and capacitor, and an optional capacitor, are placed between the COMP pin and ground.

Oscillator

The internal oscillator frequency is set to a typical 350kHz as a fixed frequency for PWM operation.

Slope Compensation

In order to prevent sub-harmonic oscillations that may occur over all specified load and line conditions when operating at duty cycle higher than 50%, the RT6204 features an internal slope compensation, which adds a compensating slope signal to the sensed current signal to support applications with duty cycle up to 93%.

There is an exclusive condition for the internal slope compensation. When the loading current is reducing to make the COMP voltage touch its minimum level, the internal slope compensation will be disabled to keep a minimum peak current no matter what duty cycle it is. Thus a sub-harmonic oscillation may happen if the operation duty cycle is larger than 50% and it results in a higher output ripple voltage during such kind of light load operation.

Internal Regulator

When the VIN is plugged in, the internal regulator will generate a low voltage to drive internal control circuitry and to supply the bootstrap power for the high-side gate driver.

Chip Enable

The RT6204 provides an EN pin, as an external chip enable control, to enable or disable the device. When VIN is higher than the input under-voltage lockout threshold (V_{UVLO}) with the EN voltage (V_{EN}) higher than 1.35V, the converter will be turned on. When V_{EN} is lower than 0.925V, the converter will enter into shutdown mode, during which the supply current can be even reduced to 3 μ A or below.

External Soft-Start

The RT6204 provides external soft-start feature to

reduce input inrush current. The soft-start time can be programmed by selecting the value of the capacitor C_{SS} connected from the SS pin to GND. An internal current source I_{SS} (typically, 6 μ A) charges the external capacitor C_{SS} to build a soft-start ramp voltage. The feedback voltage V_{FB} will be compared with the soft-start ramp voltage during soft-start time. For the RT6204, the external capacitor C_{SS} is required, and for soft-start control, the SS pin should never be left unconnected, and it is not recommended to be connected to an external voltage source. The soft-start time depends on RC time constant; for example, a 0.1 μ F capacitor for programming soft-start time will result in 18.333ms (typ.) soft-start time.

Output Under-Voltage Protection (UVP) with Hiccup Mode

The RT6204 provides under-voltage protection with hiccup mode. When the feedback voltage V_{FB} drops below under-voltage protection threshold V_{TH-UVP} , half of the feedback reference voltage V_{REF} , the UVP function will be triggered to turn off the high-side MOSFET immediately. The converter will attempt auto-recovery soft-start after under-voltage condition has occurred for a period of time. Once the under-voltage condition is removed, the converter will resume switching and be back to normal operation.

Current Limit Protection

The RT6204 provides cycle-by-cycle current limit protection against over-load or short-circuited condition. When the peak inductor current reaches the current limit, the high-side MOSFET will be turned off immediately with no violating minimum on-time t_{ON_MIN} requirement to prevent the device from operating in an over-current condition.

Thermal Shutdown

The RT6204 provides over-temperature protection (OTP) function to prevent the chip from damaging due to over-heating. The over-temperature protection function will shut down the switching operation when the junction temperature exceeds 165°C. Once the over-temperature condition is removed, the converter will resume switching and be back to normal operation.

Absolute Maximum Ratings (Note 1)

- VIN (Note 5)----- -0.3V to 80V
- SW
 - DC----- -0.3V to (VIN + 0.3V)
 - <200ns----- -5V to (VIN + 4V)
- EN Pin----- -0.3V to 80V
- BOOT to SW, VBOOT – VSW----- -0.3V to 6V
- Other Pins----- -0.3V to 6V
- Power Dissipation, PD @ TA = 25°C
 - SOP-8 (Exposed Pad) ----- 3.44W
- Package Thermal Resistance (Note 2)
 - SOP-8 (Exposed Pad), θJA ----- 29°C/W
 - SOP-8 (Exposed Pad), θJC ----- 2°C/W
- Lead Temperature (Soldering, 10 sec.)----- 260°C
- Junction Temperature----- 150°C
- Storage Temperature Range----- -65°C to 150°C
- ESD Susceptibility (Note 3)
 - HBM (Human Body Model) ----- 2kV

Recommended Operating Conditions (Note 4)

- Supply Input Voltage ----- 5.2V to 60V
- Ambient Temperature Range----- -40°C to 85°C
- Junction Temperature Range ----- -40°C to 125°C

Electrical Characteristics

(VIN = 12V, TA = 25°C, unless otherwise specified)

Parameter	Symbol	Test Conditions	Min	Typ	Max	Unit
Supply Current						
Shutdown Supply Current	ISHDN	VEN = 0V	--	0.5	3	µA
		VEN = 0V, VIN = 60V	--	20	--	
Quiescent Supply Current	IQ	VEN = 3V, VFB = 0.9V	--	0.6	--	mA
Reference						
Feedback Reference Voltage	VREF	5V ≤ VIN ≤ 60V	0.788	0.8	0.812	V
Enable and UVLO						
Input Under-Voltage Lockout Threshold	VUVLO	VIN Rising	4	4.6	5.2	V
Input Under-Voltage Lockout Hysteresis	VUVLO_HYS		200	350	500	mV

Parameter		Symbol	Test Conditions	Min	Typ	Max	Unit
EN Input Threshold Voltage	Rising	V_{TH_EN}		1.15	1.25	1.35	V
	Hysteresis	$V_{TH_EN_HYS}$	Falling	25	--	225	mV
Error Amplifier							
Error Amplifier Transconductance		g_{m_EA}	$\Delta I_C = \pm 10\mu A$	--	970	--	$\mu A/V$
Error Amplifier Source/Sink Current				--	160	--	μA
COMP to Current Sense Transconductance		g_{m_CS}		--	0.9	--	A/V
Internal MOSFET							
High-Side Switch On-Resistance		$R_{DS(ON)_H1}$		--	660	850	m Ω
		$R_{DS(ON)_H2}$	$V_{IN} = 60V$	--	890	1200	
Low-Side Switch On-Resistance		$R_{DS(ON)_L}$		--	330	500	m Ω
Switching							
Oscillation Frequency		f_{OSC1}		--	350	--	kHz
Short-Circuit Oscillation Frequency		f_{OSC2}	$V_{FB} = 0V$	--	100	--	kHz
Maximum Duty Cycle		D_{MAX}	$V_{FB} = 0.7V$	--	93	--	%
Minimum On-Time		t_{ON_MIN}		--	90	--	ns
Soft-Start							
Soft-Start Current		I_{SS}	$V_{SS} = 0V$	--	6	--	μA
Protection Function							
High-Side Switch Leakage Current			$V_{EN} = 0V, V_{SW} = 0V$	--	0	10	μA
High-Side Switch Current Limit		I_{LIM_HS}	Minimum duty cycle	600	860	--	mA
Under-Voltage Protection Threshold		V_{TH_UVP}	After soft-start, with respect to V_{FB}	--	50	--	%
Thermal Shutdown		T_{SD}		--	165	--	$^{\circ}C$

Note 1. Stresses beyond those listed “Absolute Maximum Ratings” may cause permanent damage to the device. These are stress ratings only, and functional operation of the device at these or any other conditions beyond those indicated in the operational sections of the specifications is not implied. Exposure to absolute maximum rating conditions may affect device reliability.

Note 2. θ_{JA} is measured under natural convection (still air) at $T_A = 25^{\circ}C$ with the component mounted on a high effective-thermal-conductivity four-layer test board on a JEDEC 51-7 thermal measurement standard. θ_{JC} is measured at the exposed pad of the package.

Note 3. Devices are ESD sensitive. Handling precaution recommended.

Note 4. The device is not guaranteed to function outside its operating conditions.

Note 5. When V_{IN} is beyond the recommended operating voltage (60V) and within the absolute maximum voltage (80V), the conducting current through SW pin has to be less than 0.5A to avoid instant damage to the devices.

Typical Application Circuit

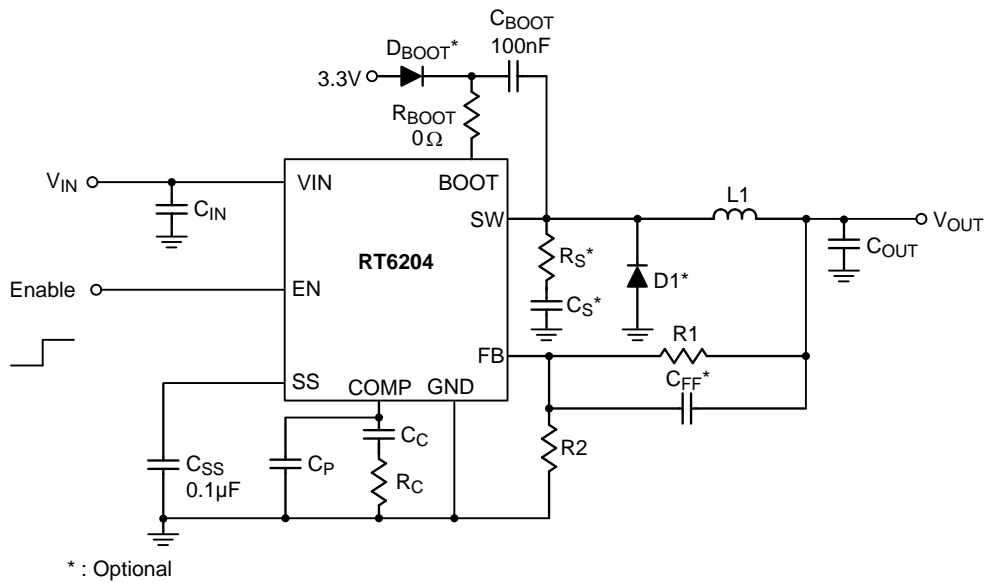

Table 1. Suggested component selections for the application of 500mA load current for some common output voltages

V _{OUT} (V)	R ₁ (kΩ)	R ₂ (kΩ)	L ₁ (µH)	C _{OUT} (µF)	R _C (kΩ)	C _C (nF)	C _P (pF)
1	2.49	10	22	20	4.02	6.8	NC
1.2	4.99	10	22	20	4.99	6.8	NC
1.8	12.4	10	33	20	6.98	6.8	NC
2.5	21	10	33	20	10	6.8	NC
3.3	30.9	10	47	20	16	6.8	68
5	52.3	10	100	20	24	6.8	47
9	102	10	150	20	34.9	6.8	47
12 (Note)	140	10	220	20	34.9	6.8	47

Note : For V_{IN} < 17V & V_{OUT} = 12V application, the snubber components need to be added (R_S = 3.9Ω, C_S = 1nF)

Typical Operating Characteristics

($T_A = 25^\circ\text{C}$, unless otherwise specified)

Efficiency vs. Output Current

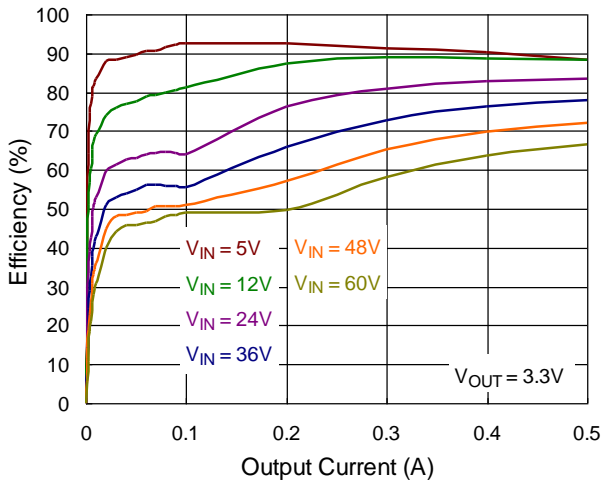

Efficiency vs. Output Current

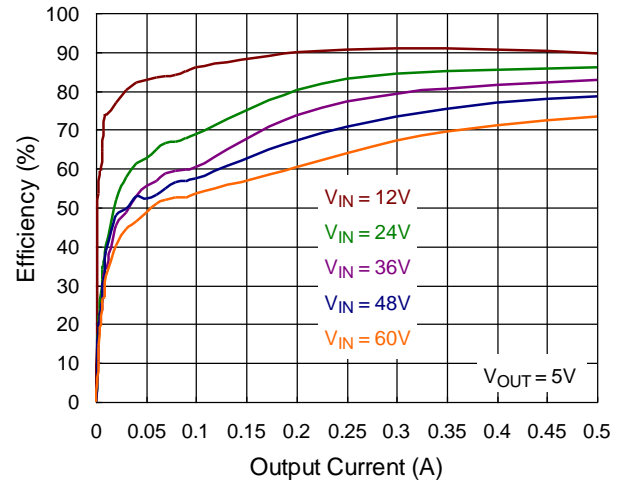

Efficiency vs. Output Current

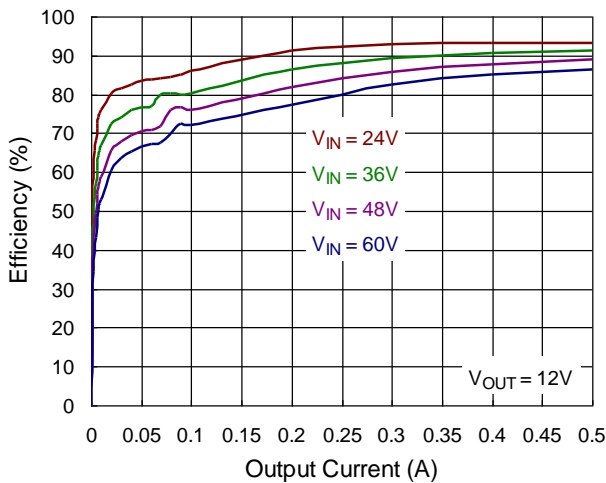

Efficiency vs. Input Voltage

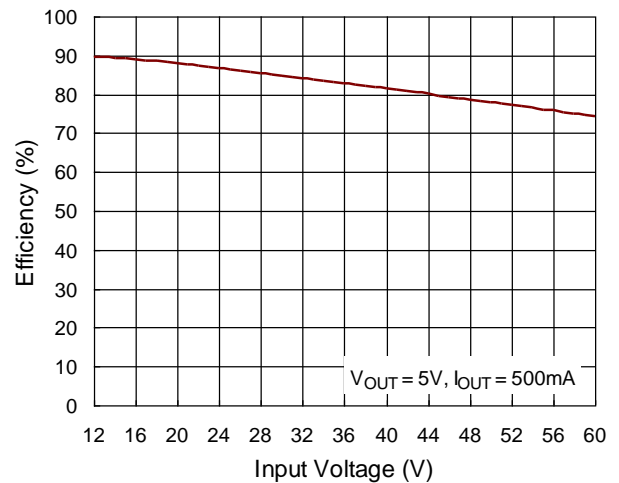

Output Voltage vs. Output Current

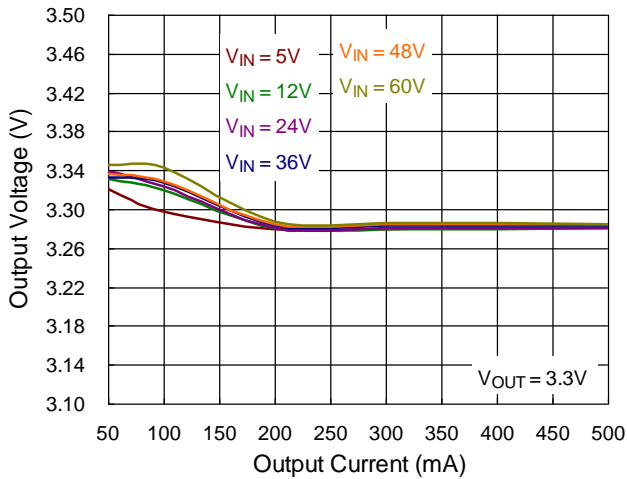

Output Voltage vs. Input Voltage

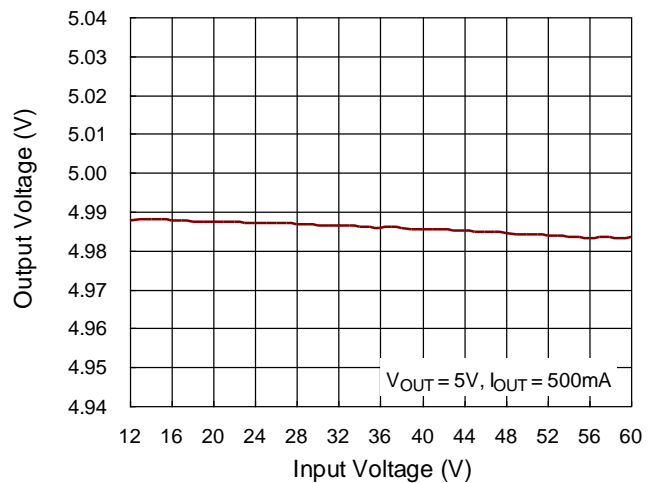

Typical Operating Characteristics (continued)

Feedback Voltage vs. Input Voltage

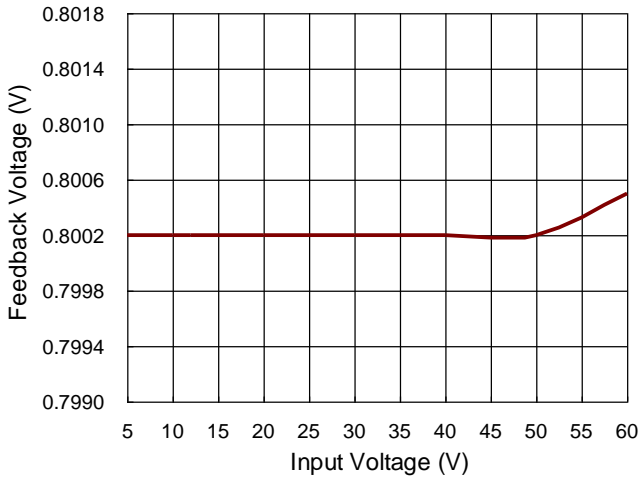

Feedback Voltage vs. Temperature

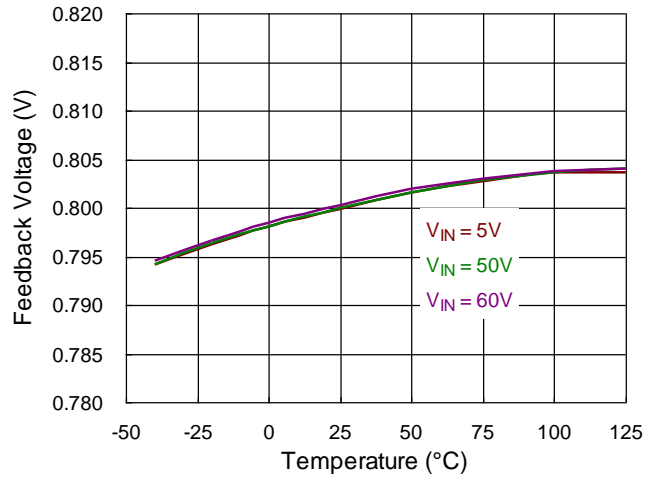

Oscillation Frequency vs. Input Voltage

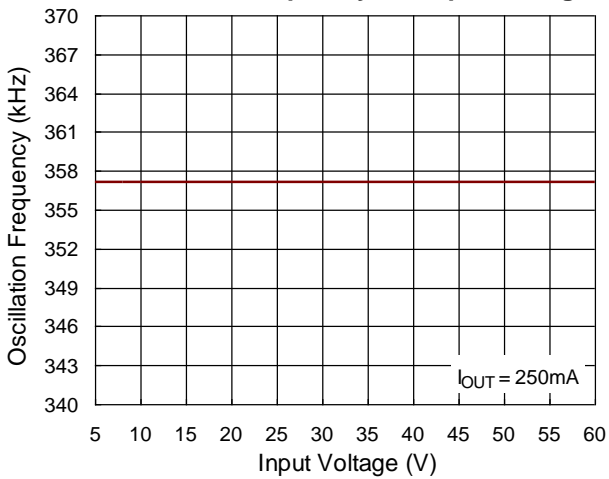

Oscillation Frequency vs. Temperature

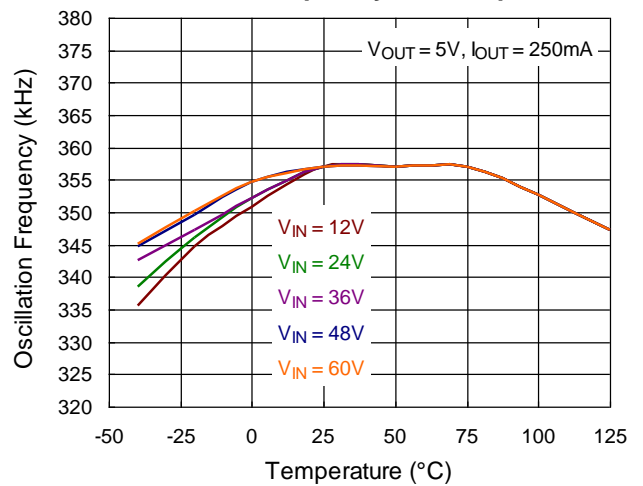

Upper SW Current Limit vs. Input Voltage

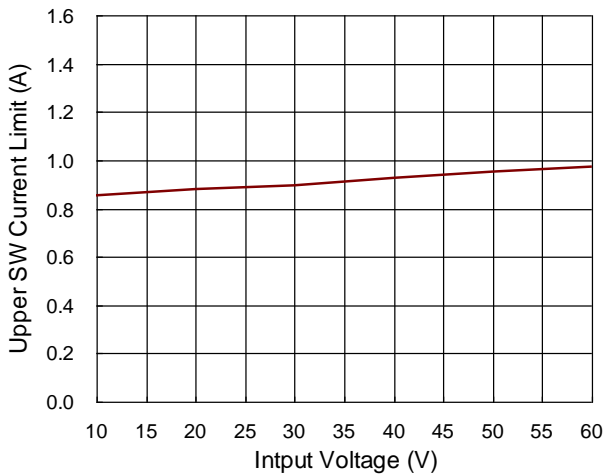

Upper SW Current Limit vs. Temperature

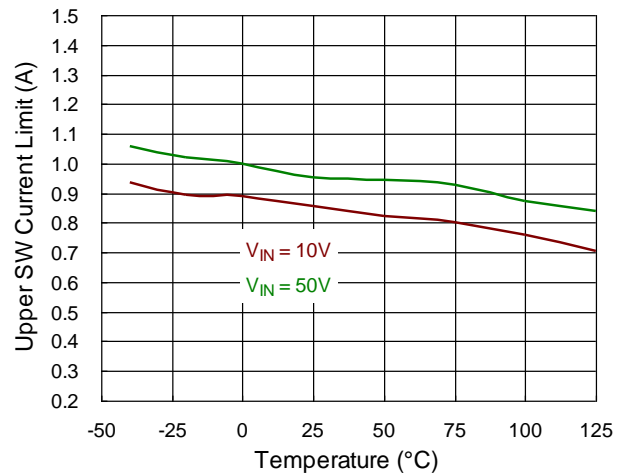

Typical Operating Characteristics (continued)

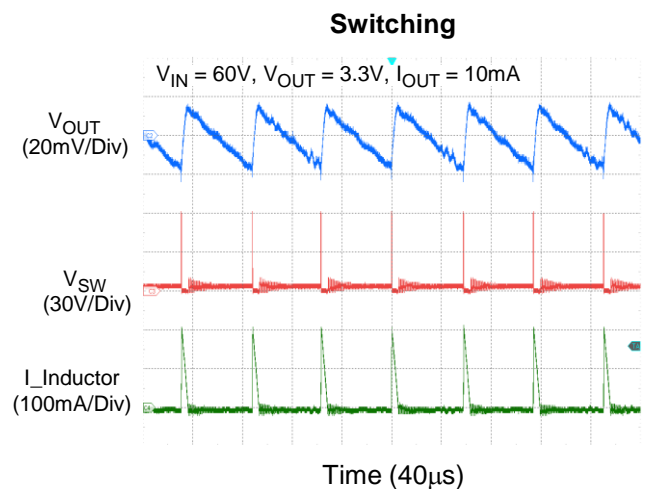
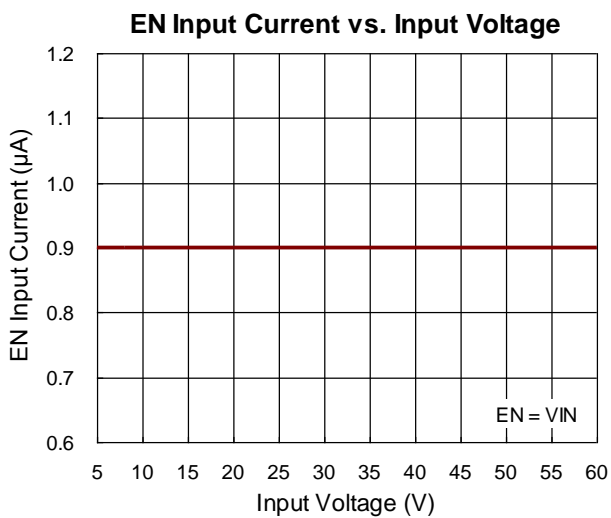
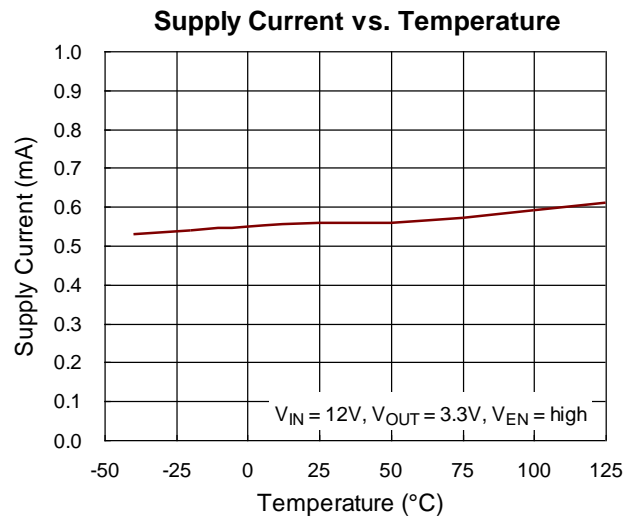
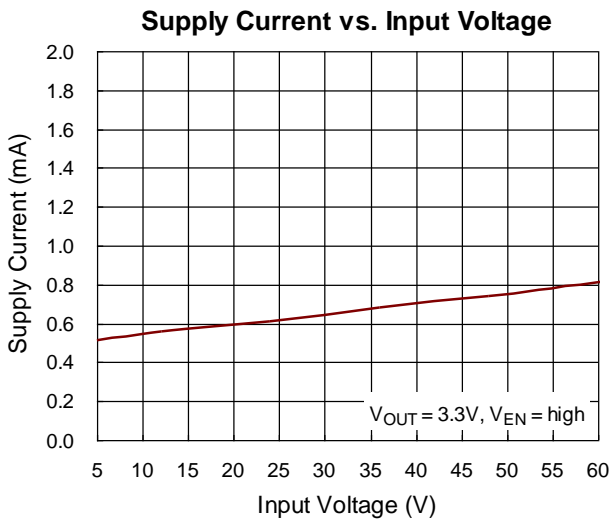
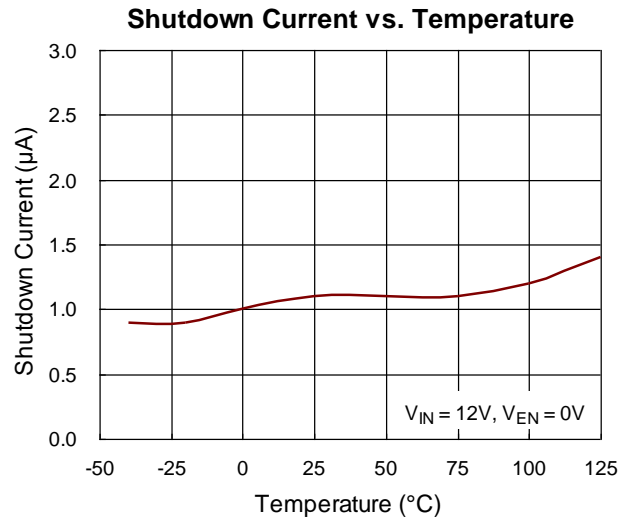
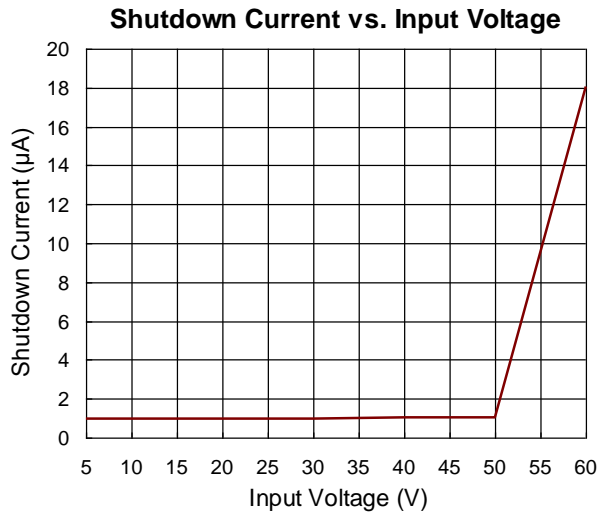

Typical Operating Characteristics (continued)

Switching

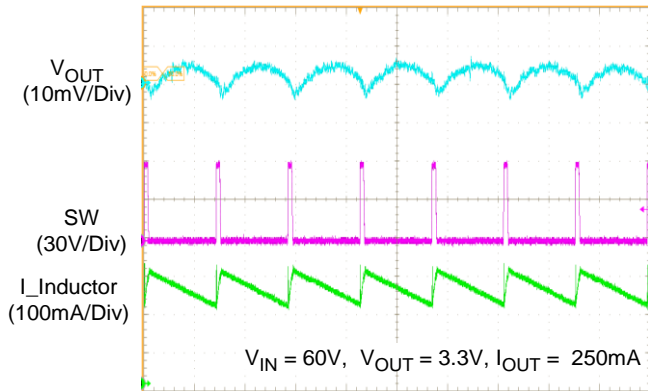

Time (2 μ s/Div)

Switching

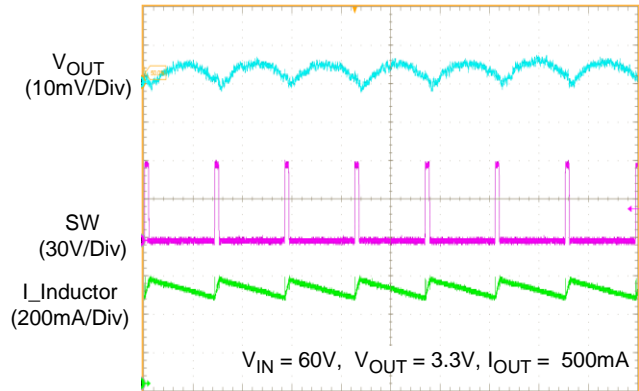

Time (2 μ s/Div)

Power On from EN

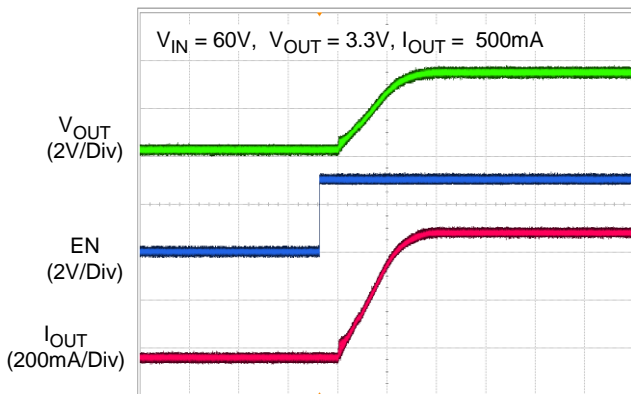

Time (10ms/Div)

Power Off from EN

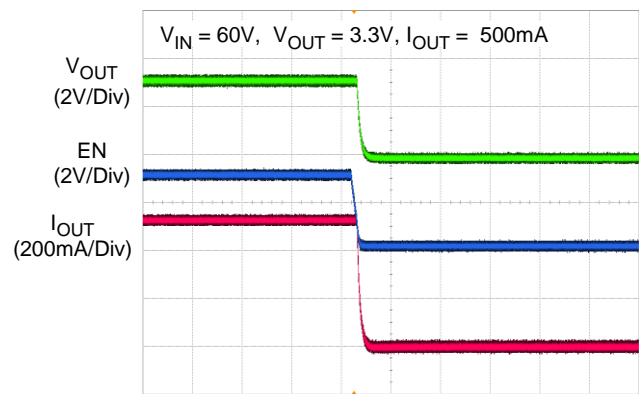

Time (1ms/Div)

Power On from VIN

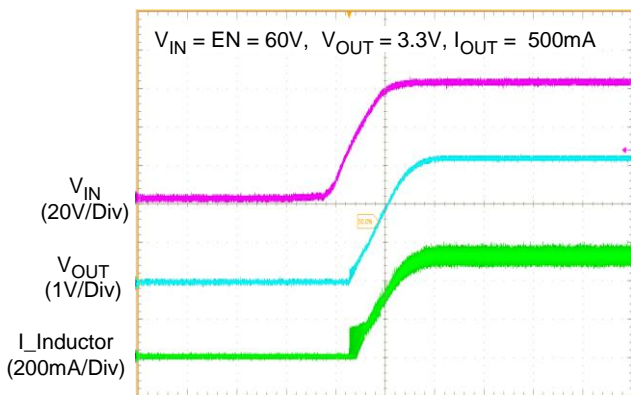

Time (10ms/Div)

Power Off from VIN

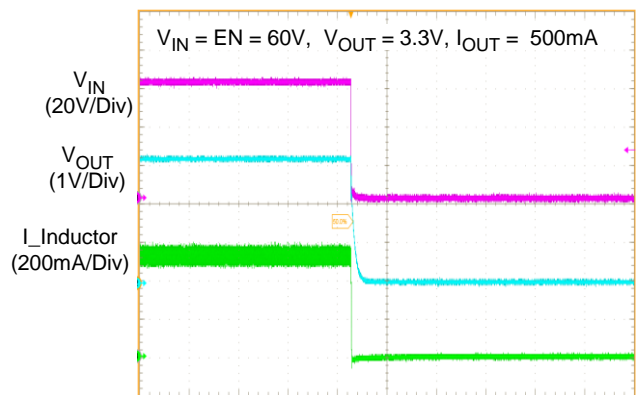

Time (1ms/Div)

Application Information

Output Voltage Setting

The output voltage can be adjusted by setting the feedback resistors R1 and R2, as Figure 1. Choose a 10kΩ resistor for R2 and calculate R1 by using the equation below :

$$V_{OUT} = V_{FB} \times \left(1 + \frac{R1}{R2}\right)$$

where V_{FB} is the feedback voltage (typically equal to V_{REF})

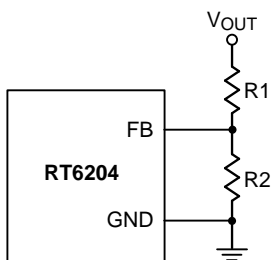

Figure 1. Output Voltage Setting by a Resistive Voltage Divider

Chip Enable Operation

The RT6204 provides enable/disable control through the EN pin. The chip remains in shutdown mode by pulling the EN pin below Logic-Low threshold (0.95V). During the shutdown mode, the RT6204 disables most of the logic circuitry to lower the quiescent current. When V_{EN} rises above Logic-High threshold (V_{TH_EN} 1.35V), the RT6204 will begin initialization for a new soft-start cycle.

If the EN pin is floating, V_{EN} will be pulled Low by a 1μA current drawn from the EN pin. Connecting a 1kΩ to 100kΩ pull-up resistor is recommended. An external MOSFET can be added to implement a logic-controlled enable control. Figure 2 shows the power up sequence, which is controlled by the EN pin.

The RT6204 also provides enable control through V_{IN} pin. If the V_{EN} is above Logic-High threshold first, the chip will remain in shutdown mode until the V_{IN} rises above V_{UVLO}.

Figure 3 shows the power up sequence, which is controlled by the V_{IN} pin.

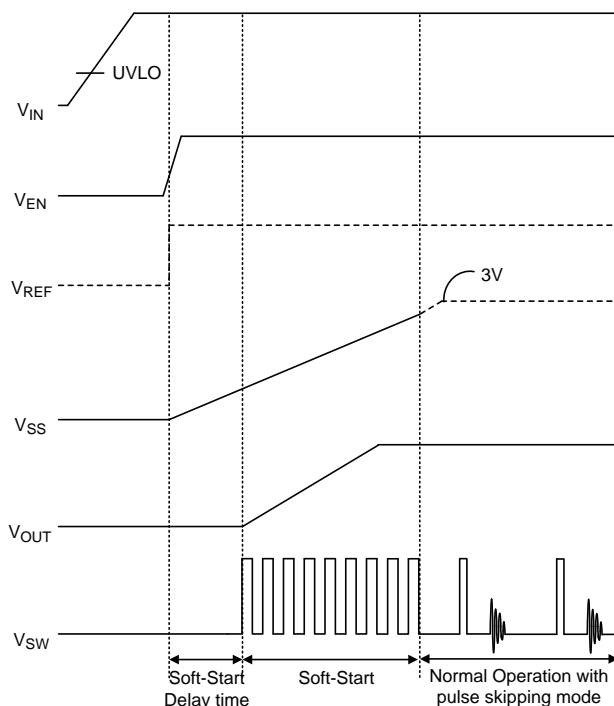

Figure 2. Power-Up Sequence Controlled by the EN Pin

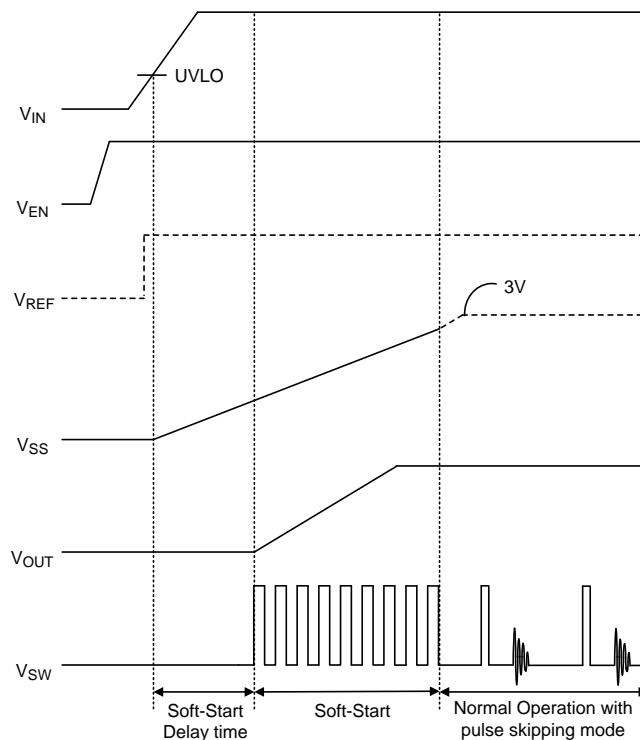

Figure 3. Power-Up Sequence Controlled by the VIN Pin

Soft-Start

When start-up, a large inrush may be observed for high output voltages and output capacitances. To solve this, the RT6204 provides an external soft-start function to reduce input inrush current to meet various applications.

For the RT6204, the soft-start time t_{SS} can be programmed by selecting the value of the capacitor C_{SS} connected between the SS pin and GND. During the soft-start period, an internal pull-up current source I_{SS} (typically, $6\mu A$) charges the external capacitor C_{SS} to generate a soft-start voltage ramp, and then output voltage will follow this voltage ramp to monotonically start up.

The soft-start time can be calculated as :

$$t_{SS} = \frac{[C_{SS} \times (V_{REF} + 0.3V)]}{I_{SS}}$$

where $I_{SS} = 6\mu A$ (typical), V_{REF} is the feedback reference voltage, and C_{SS} is the external capacitor placed from the SS pin to GND, where a 10nF to 100nF capacitor is recommended to set the soft-start time from 1.833ms to 18.333ms.

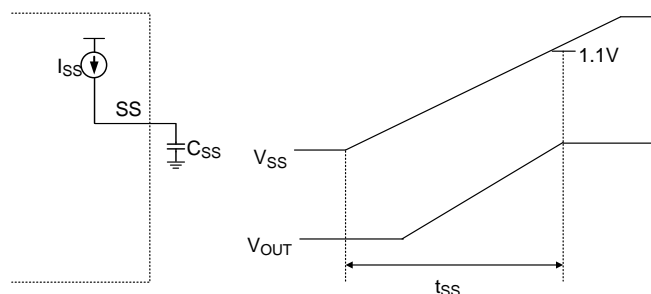

Figure 4. External Soft-Start Time Setting

Current Limit

The RT6204 provides peak current limit function to prevent chip damaging from short-circuited output, the VIN voltage and SW voltage are sensed when the internal high-side MOSFET is turned on. During this period, the VIN-SW voltage is increasing when the inductor current is increasing. The peak inductor current will be monitored every switching cycle. If the current sense signal exceeds the internal current limit, clamped by the maximum COMP voltage, the high-side

MOSFET will be turned off immediately, while the minimum on-time t_{ON_MIN} requirement still needs to be met, to prevent the device from operating in an over-current condition.

In the current-limited condition, the maximum sourcing current is fixed because the peak inductor current is limited. When the load is further increasing and is over the sourcing capability of the high-side switch, the output voltage will start to drop and eventually be lower than the under-voltage protection threshold so that the IC will enter shutdown mode and may restart with hiccup mechanism.

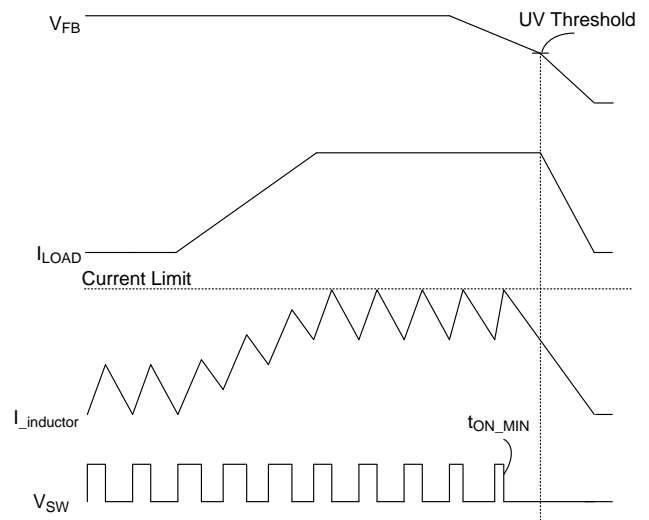

Figure 5. Peak-Current Limit

Under-Voltage Protection

The feedback voltage is constantly monitored for under-voltage protection. When the feedback voltage is lower than under-voltage protection threshold V_{TH_UVP} , the under-voltage protection is triggered, the high-side MOSFET will be turned off and the low-side MOSFET is turned on to discharge the output voltage. The under-voltage protection is not a latched mechanism; if the under-voltage condition remains for a period of time, the RT6204 will enter hiccup mode. During the soft-start time, the under-voltage protection is masked and a $5\mu s$ deglitch time is built in the UVP circuit to prevent false transitions.

Hiccup Mode

If the under-voltage protection condition continues for a period of time, the RT6204 will enter hiccup mode, in which the soft-start process will be initialized without

V_{IN} being re-powered on. During this period of time, the SW starts to switch since the under-voltage protection is masked during soft-start time. When soft-start finishes, if the under-voltage condition is removed, the converter will resume normal operation; if the under-voltage condition, however, still remains, that is, the FB voltage is still lower than under-voltage threshold V_{TH_UVP}, the under-voltage protection will be triggered again. The cycle will repeat until this fault condition is removed.

Output Voltage Limitation

The output voltage must be set higher than (V_{IN} × 6.3%) due to the limitation of the minimum on-time t_{ON_MIN} and switching frequency. When current limiting protection is triggered and the load current is still increasing slowly, the output voltage will start to drop and the on-time of the high-side MOSFET will decrease as well. When the output voltage drops below V_{TH_UVP}, the under-voltage protection is triggered to turn off the internal driver to protect the converter. If the output voltage, however, does not drop below V_{TH_UVP} yet when the on-time of the high-side MOSFET has decreased to t_{ON_MIN} (~90ns), the internal gate driver will keep switching to maintain the output voltage, which may damage the chip under this over-current condition.

In order to make sure the output voltage can drop below V_{TH_UVP} once current limiting protection is triggered, the output voltage setting must be satisfied with the equation below :

The output voltage at the time, when the switch has been turned on for the minimum on-time, is

$$V_{OUT_MIN} = V_{IN} \times t_{ON_MIN} \times f_{OSC1} = 0.0315V_{IN}$$

where t_{ON_MIN} = ~90ns, f_{OSC1} = 350kHz

The UVP is triggered when the V_{FB} is lower than V_{TH_UVP}, which is 50%. That is to say V_{OUT_MIN} should be lower than 50% of the actual V_{OUT} to guarantee the UVP can be triggered under this condition.

$$V_{OUT_MIN} < 0.5 \times V_{OUT}$$

The duty cycle limitation can be obtained.

$$D_{MIN} > 0.063$$

For example, if the V_{IN} = 50V, the V_{OUT} should be set higher than 3.15V.

External Bootstrap Diode

A 0.1μF capacitor C_{BOOT}, where a low ESR ceramic capacitor is typically used, is connected between the BOOT and SW pins to provide the gate driver supply voltage for the high-side N-MOSFET.

It is recommended to add an external bootstrap diode from an external 3.3V supply voltage to the BOOT pin to improve efficiency when the input voltage V_{IN} is lower than 5.5V or duty cycle is higher than 65%. A low-cost bootstrap diode can be used, such as IN4148 or BAT54.

Note that the external BOOT voltage must be lower than 5.5V.

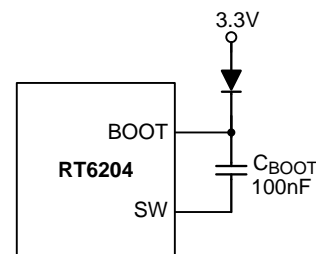

Figure 6. External Bootstrap Diode

Inductor Selection

Output inductor plays a very important role in step-down converters because it stores energy from input power rail and releases to output load. For better efficiency, DC resistance (DCR) of the inductor must be minimized to reduce copper loss. In addition, since the inductor takes up most of the PCB space, its size also matters. Low-profile inductors can also save board space if height limitation exists. However, low-DCR and low-profile inductors are usually not cost effective.

On the other hand, while larger inductance may lower ripple current, and then power loss, rise time of the inductor current, however, increases with inductance, which degrades the transient responses. Therefore, the inductor design is a trade-off among performance, size and cost.

The first thing to consider is inductor ripple current. The inductor ripple current is recommended in the range of 20% to 40% of full-load current, and thus the inductance can be calculated using the following equation.

$$L_{MIN} = \frac{V_{IN} - V_{OUT}}{f_{SW} \times k \times I_{OUT}} \times \frac{V_{OUT}}{V_{IN}}$$

where k is the ratio of peak-to-peak ripple current to rated output current. From above, 0.2 to 0.4 of the ratio k is recommended.

The next thing to consider is inductor saturation current. Choose an inductor with saturation current rating greater than maximum inductor peak current. The peak inductor current can be calculated using the following equation :

$$\Delta I_L = \frac{V_{IN} - V_{OUT}}{L_{MIN} \times f_{SW}} \times \left(\frac{V_{OUT}}{V_{IN}} \right)$$

where ΔI_L is the inductor peak to peak current, and

$$I_{L_PEAK} = I_{OUT} + \frac{\Delta I_L}{2}$$

Input Capacitor Selection

A high-quality ceramic capacitor of 4.7 μ F or greater, such as X5R or X7R, are recommended for the input decoupling capacitor. X5R and X7R ceramic capacitors are commonly used in power regulator applications because the dielectric material has less capacitance variation and more temperature stability.

Voltage rating and current rating are the key parameters to select an input capacitor. An input capacitor with voltage rating 1.5 times greater than the maximum input voltage is a conservative and safe design choice. As for current rating, the input capacitor is used to supply the input RMS current, which can be approximately calculated using the following equation :

$$I_{IN_RMS} = I_{OUT} \times \sqrt{\frac{V_{OUT}}{V_{IN}} \times \left(1 - \frac{V_{OUT}}{V_{IN}} \right)}$$

It is practical to have several capacitors with low equivalent series resistance (ESR), being paralleled to form a capacitor bank, to meet size or height requirements, and to be placed close to the drain of the high-side MOSFET, which is very helpful in reducing input voltage ripple at heavy load. Besides, the input voltage ripple is determined by the input capacitance, which can be approximately calculated by the following equation :

$$\Delta V_{IN} = \frac{I_{OUT(MAX)}}{C_{IN} \times f_{SW}} \times \frac{V_{OUT}}{V_{IN}} \times \left(1 - \frac{V_{OUT}}{V_{IN}} \right)$$

Output Capacitor Selection

Output capacitance affects stability of the control feedback loop, ripple voltage, and transient response. In steady state condition, inductor ripple current flows into the output capacitor, which results in voltage ripple. Output voltage ripple V_{RIPPLE} can be calculated by the following equation :

$$V_{RIPPLE} = \Delta I_L \times \left(ESR + \frac{1}{8 \times C_{OUT} \times f_{SW}} \right)$$

where ΔI_L is the peak-to-peak inductor current.

The output inductor and capacitor form a second-order low-pass filter for the buck converter.

It takes a few switching cycles to respond to load transient due to the delay from the control loop. During the load transient, the output capacitor will supply current before the inductor can supply current high enough to output load. Therefore, a voltage drop, caused by the current change onto output capacitor, and the current flowing through ESR of the capacitor, will occur. To meet the transient response requirement, the output capacitance should be large enough and its ESR should be as small as possible. The output voltage drop (ΔV) can be calculated by the equation below :

$$\Delta V = \Delta I_{OUT} \times ESR + \frac{\Delta I_{OUT}}{C_{OUT}} \times t_s$$

$$C_{OUT} > \frac{\Delta I_{OUT} \times t_s}{\Delta V - (\Delta I_{OUT} \times ESR)}$$

where ΔI_{OUT} is the size of the output current transient, and t_s is the control-loop delay time. For the worst-case scenario, from no load to full load, t_s is about 1 to 3 switching cycles.

Given that a transient response requirement is 4% for 5V output voltage V_{OUT} , output current transient ΔI_{OUT} is from 0A to 0.5A, ESR of the ceramic capacitor is 2m Ω , t_s is 3 switching cycles for the longest delay, and switching frequency is 350kHz, a minimum output capacitance 21.53 μ F can then be calculated from above.

Another factor for output voltage drop is equivalent series inductance (ESL). A big change in load current, i.e. large di/dt, along with the ESL of the capacitor,

causes a drop on the output voltage. A better transient performance can be obtained by using a capacitor with low ESL. Generally, using several capacitors connected in parallel can have better transient performance than using a single capacitor with the same total ESR.

External Diode Selection

In order to reduce conduction loss, an external diode between SW pin and GND is recommended. Since a low forward voltage of a diode may cause low conduction loss during OFF-time, SCHOTTKY diodes with current rating greater than maximum inductor peak current are good design choice for the application. During the on-time, the diode can prevent the reverse voltage back to the input voltage. Therefore, the voltage rating should be higher than maximum input voltage.

Thermal Considerations

The junction temperature should never exceed the absolute maximum junction temperature $T_{J(MAX)}$, listed under Absolute Maximum Ratings, to avoid permanent damage to the device. The maximum allowable power dissipation depends on the thermal resistance of the IC package, the PCB layout, the rate of surrounding airflow, and the difference between the junction and ambient temperatures. The maximum power dissipation can be calculated using the following formula :

$$P_{D(MAX)} = (T_{J(MAX)} - T_A) / \theta_{JA}$$

where $T_{J(MAX)}$ is the maximum junction temperature, T_A is the ambient temperature, and θ_{JA} is the junction-to-ambient thermal resistance.

For continuous operation, the maximum operating junction temperature indicated under Recommended Operating Conditions is 125°C. The junction-to-ambient thermal resistance, θ_{JA} , is highly package dependent. For a SOP-8 (Exposed Pad) package, the thermal resistance, θ_{JA} , is 29°C/W on a standard JEDEC 51-7 high effective-thermal-conductivity four-layer test board. The maximum power dissipation at $T_A = 25^\circ\text{C}$ can be calculated as below :

$$P_{D(MAX)} = (125^\circ\text{C} - 25^\circ\text{C}) / (29^\circ\text{C/W}) = 3.44\text{W for a SOP-8 (Exposed Pad) package.}$$

The maximum power dissipation depends on the

operating ambient temperature for fixed $T_{J(MAX)}$ and thermal resistance, θ_{JA} . The derating curve in Figure 7 allows the designer to see the effect of rising ambient temperature on the maximum power dissipation.

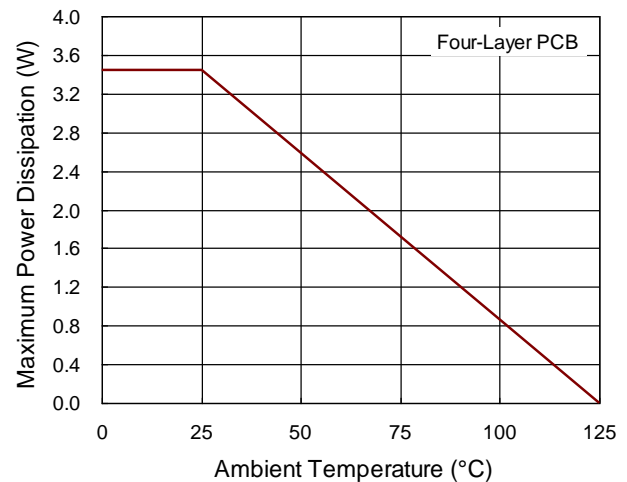

Figure 7. Derating Curve of Maximum Power Dissipation

Layout Considerations

PCB layout is very important for high-frequency switching converter applications. The PCB traces can radiate excessive noise and contribute to converter instability with improper layout. It is good design to mount power components and route the power traces on the same layer. If the power trace, for example, V_{IN} trace, must be routed to another layer, there must be enough vias on the power trace for passing current through with less power loss. The width of power trace is decided by the maximum current which may go through. With wide traces and enough vias, resistance of the entire power trace can be reduced to minimum to improve converter performance. Below are some other layout guidelines, which should be considered :

- ▶ Place input decoupling capacitors close to the VIN pin. Input capacitor can provide instant current to the converter when high-side MOSFET is turned on. It is better to connect the input capacitors to the VIN pin directly with a trace on the same layer.
- ▶ Place an inductor close to the SW pin and the trace between them should be wide and short. It can gain better efficiency with minimum resistance of the SW trace since the output current will flow through the SW trace. It is also a good design to keep the area of SW

trace as large as possible, without affecting other paths. The area can help dissipate the heat in the internal power stages. However, since a large voltage and current variation usually occur on the SW trace, any sensitive trace should be kept away from this node.

- The connection point of the feedback trace on the VOUT side should be kept away from the current path for the VOUT trace and be close to the output capacitor,

which is closest to the inductor. The feedback trace should be also kept away from any dirty trace, for example, a trace with high dv/dt , di/dt , or current rating, etc., and the total length should be kept as short as possible to reduce the risk of noise coupling, and the signal delay.

- If possible, tie the grounds of the input capacitor and the output capacitor together as the same reference ground.

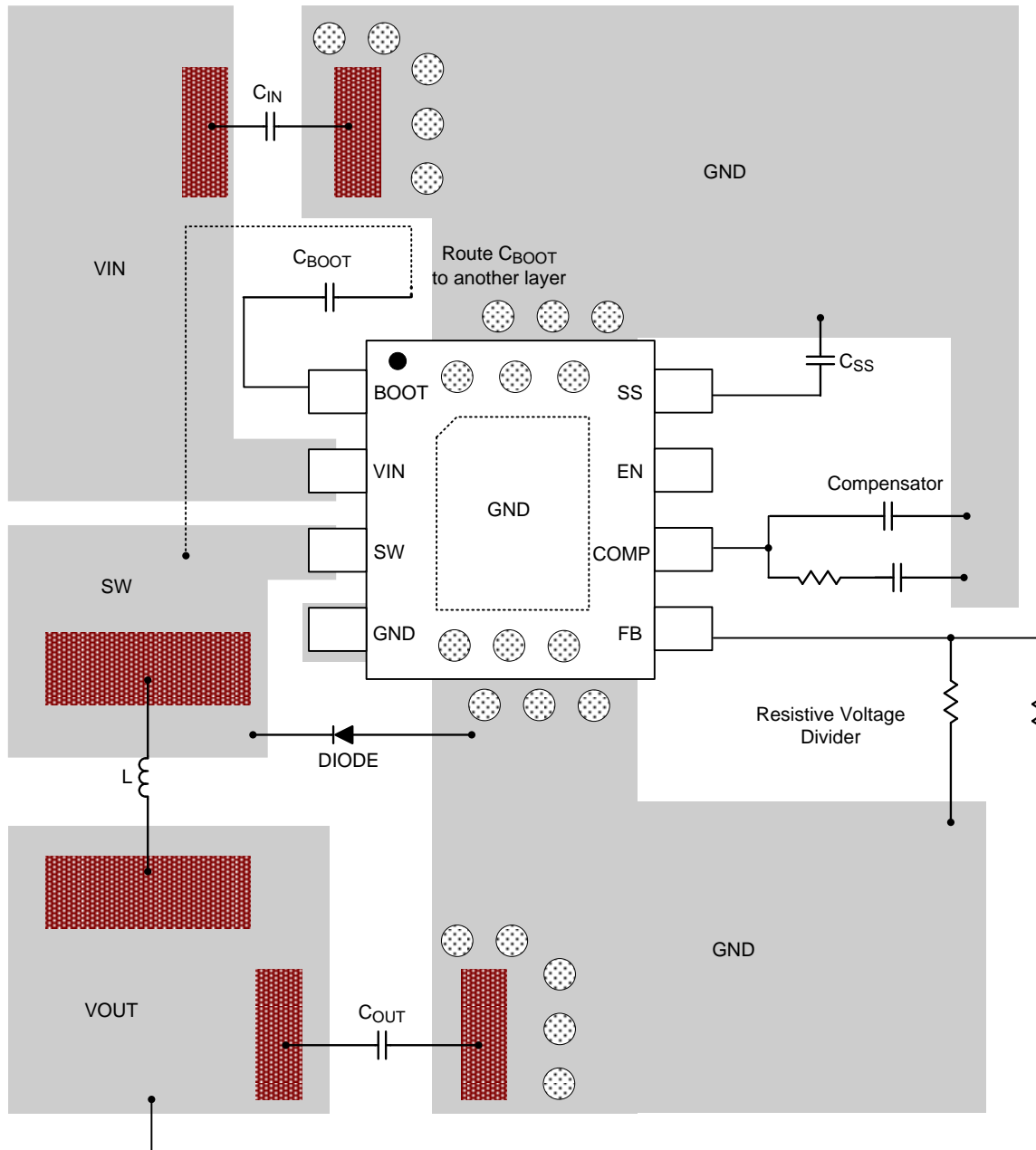
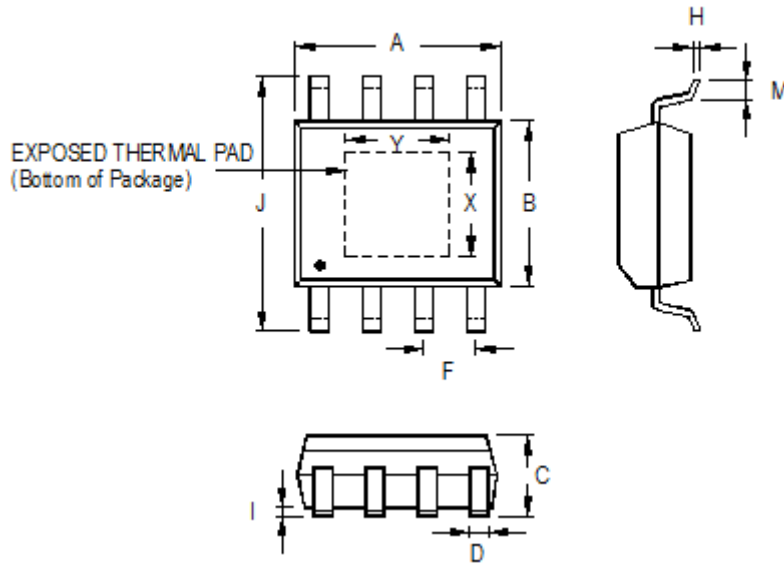

Figure 8. PCB Layout Guide

Outline Dimension



Symbol	Dimensions In Millimeters		Dimensions In Inches		
	Min	Max	Min	Max	
A	4.801	5.004	0.189	0.197	
B	3.810	4.000	0.150	0.157	
C	1.346	1.753	0.053	0.069	
D	0.330	0.510	0.013	0.020	
F	1.194	1.346	0.047	0.053	
H	0.170	0.254	0.007	0.010	
I	0.000	0.152	0.000	0.006	
J	5.791	6.200	0.228	0.244	
M	0.406	1.270	0.016	0.050	
Option 1	X	2.000	2.300	0.079	0.091
	Y	2.000	2.300	0.079	0.091
Option 2	X	2.100	2.500	0.083	0.098
	Y	3.000	3.500	0.118	0.138

8-Lead SOP (Exposed Pad) Plastic Package

Richtek Technology Corporation

14F, No. 8, Tai Yuen 1st Street, Chupei City
 Hsinchu, Taiwan, R.O.C.
 Tel: (8863)5526789

Richtek products are sold by description only. Richtek reserves the right to change the circuitry and/or specifications without notice at any time. Customers should obtain the latest relevant information and data sheets before placing orders and should verify that such information is current and complete. Richtek cannot assume responsibility for use of any circuitry other than circuitry entirely embodied in a Richtek product. Information furnished by Richtek is believed to be accurate and reliable. However, no responsibility is assumed by Richtek or its subsidiaries for its use; nor for any infringements of patents or other rights of third parties which may result from its use. No license is granted by implication or otherwise under any patent or patent rights of Richtek or its subsidiaries.

Copyright © 2018 Richtek Technology Corporation. All rights reserved. **RICHTEK** is a registered trademark of Richtek Technology Corporation.