

## I<sup>2</sup>C Programmable Multi-Channel PMU with Battery Charger for CMOS DSC/DV

### General Description

The RT5016C is a complete power supply solution for digital still cameras and other hand held devices. The RT5016C is composed of a multi-channel DC-DC power converter unit, a single-cell linear Li-ion battery charger, a charger type detector, and an I<sup>2</sup>C control interface.

The power converter unit includes one synchronous step-up converter (CH1), one synchronous step-up/down converter (CH2), three synchronous step-down converters (CH3/4/5), two LDOs with input power as low as 1.5V (CH6/8), one WLED driver in synchronous high-voltage step-up mode or low-voltage current regulator mode (CH7), and a keep-alive LDO (CH9) for RTC application. All converters are internally frequency compensated and integrate power MOSFETs. The power converter unit provides complete protection functions : over-current, thermal shutdown, over-voltage, and under-voltage protection. The RT5016C has a WAKEUP impulse generation circuitry to monitor VIN or BAT installation event. To fulfill most of applications, the RT5016C has six preset power-on/off sequences.

The battery charger includes Auto Power Path Management (APPM). No external MOSFETs are required. The charger can enter sleep mode when power is removed.

Charging tasks are optimized by using a control algorithm to vary the charge rate, including pre-charge mode, fast charge mode and constant voltage mode. The charge current can also be programmed via the I<sup>2</sup>C control interface. The battery regulation voltage and current can be adjusted by JEITA standard temperature control or other schemes set via the I<sup>2</sup>C interface. The internal thermal feedback circuitry regulates the die temperature to optimize the charge rate for all ambient temperatures. The charging task will always be terminated in constant-voltage mode when the charging current reduces to the termination current of 10% x I<sub>CHG\_FAST</sub>. The charger includes under-voltage and over-voltage protection for the supply input voltage, VIN. The charger includes USB charger detection circuitry via D+ and D- pins of USB interface to detect USB standard downstream ports (SDP), dedicated charger port (DCP), or Apple/Sony charger ports. RT5016C uses some indicators to show charger states : two open drain ports CHG and CHG2, and an interrupt (INT) to immediately notify the state change.

The RT5016C has I<sup>2</sup>C interface to control rich functions of Power Converter Unit and Charger Unit, and is available in the WQFN-40L 5x5 package.

### Simplified Application Circuit

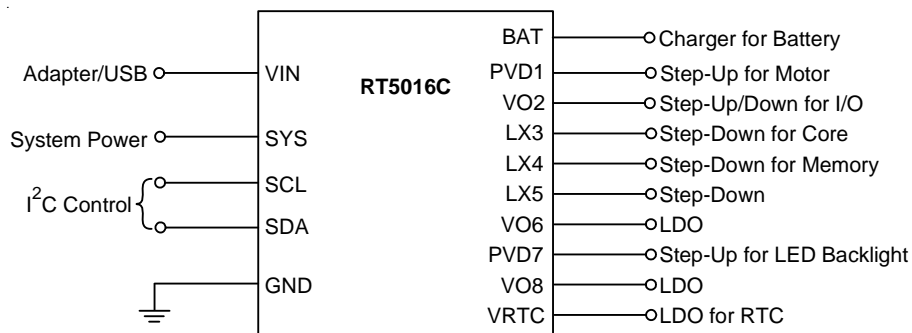

## Features

### Power Converter Unit

- CH1 LV Sync Step-Up
  - ▶ Support Up to 1A Loading, DVS (Dynamic Voltage Scaling), Load-Disconnect, Up to 95% Efficiency, PSM/PWM Selectable
- CH2 LV Sync Step-Up/Down
  - ▶ Support Up to 1A Loading, DVS, Up to 95% Efficiency, PSM/PWM Selectable
- CH3/4 LV Sync Step-Down
  - ▶ Support Up to 3A (CH3) / 2A (CH4) Loading, DVS, Up to 95% Efficiency, 100% (MAX) Duty Cycle, PSM/PWM Selectable
- CH5 LV Sync Step-Down
  - ▶ Support Up to 0.6A Loading, Up to 95% Efficiency, 100% (MAX) Duty Cycle
  - ▶ Output Voltage can be Selected from Preset List or Set by External Feedback Network
- CH6 Low Input Power LDO
  - ▶  $V_{IN}$  Range 1.5V to 5.5V
  - ▶ Output Voltage Level Selectable in I<sup>2</sup>C Register
- CH7 WLED Driver in Either Sync Step-Up Operation or Current Regulator Operation
  - ▶ Step-Up Mode with LED Open Protection (OVP7 16V or 25V, Selectable in I<sup>2</sup>C Register)
  - ▶ Step-Up Mode Support Series 2 to 6 WLED and Load Disconnect Function
  - ▶ Current Regulator Mode for 1 WLED
  - ▶ 31 WLED Dimming Levels
  - ▶ Automatic Mode Selection by External Circuit Topology
- CH8 Generic LDO
  - ▶  $V_{IN}$  Range 1.5V to 5.5V
  - ▶ Output Voltage Level Selectable in I<sup>2</sup>C Register
- CH9 Low Quiescent LDO with Reverse Leakage Prevention for RTC Power Supply
  - ▶ Fixed 3.05V Output
- Six Preset Power On/Off Sequences by One Pin SEQ
  - ▶ SEQ # 0 : CH2→CH3→CH4
  - ▶ SEQ # 1 : CH1→CH3→CH2→CH4
  - ▶ SEQ # 2 : CH1→CH3→CH4→CH2
  - ▶ SEQ # 3 : CH1→CH2→CH4→CH3

▶ SEQ # 4 : CH1→CH4→CH3→CH2

▶ SEQ # 5 : CH1→CH4→CH2→CH3

- All Power Switches Integrated with Internal Compensation
- Discharge Output of Every Channel when Turning Off
- Wake Up Impulse to Monitor BAT and VIN Plug-In
- Fixed 2MHz Switching Frequency for CH1/3/4/5, Fixed 1MHz Switching Frequency for CH2/7

### Charger Unit

- 28V Maximum Rating for  $V_{IN}$  Power
- Selectable Power Input Current Limit (0.1A / 0.5A / 1A / 1.5A)
- Auto Power Path Management (APPM) with Integrated Power MOSFETs
- Battery Charging Current Control and Regulation Voltage Control
- Programmable Charging Current and Safe Charge Timer
- Optimized Charge Rate via Thermal Feedback
- Under-Voltage Protection, Over-Voltage Protection
- Charger Status and VIN Power GOOD Indicators
- Interrupt Indicator to JEITA Temperature/Fault/Status Events when PMU is Enabled
  - ▶ Battery Temperature Events
  - ▶ Battery Removing Event
  - ▶ Charger in Thermal Regulation Control
  - ▶ Safety Timer Timeout
  - ▶ End of Charging
  - ▶ VIN Power Good
  - ▶ VIN < DPM Threshold 4.35V
  - ▶ Charger Type Detection Finishing
- Charger Type Detection
  - ▶ Dedicated Charger : Support Apple and Sony Charger
  - ▶ Secondary Charger Detection to Distinguish DCP
- I<sup>2</sup>C Control Interface : Support Fast Mode up to 400kb/s
- RoHS Compliant and Halogen Free

**Applications**

- DSC Power Supply System
- CMOS-Sensor DV
- Portable Instruments

**Ordering Information**

RT5016C □ □

- Package Type  
QW : WQFN-40L 5x5 (W-Type)
- Lead Plating System  
G : Green (Halogen Free and Pb Free)

Note :

Richtek products are :

- ▶ RoHS compliant and compatible with the current requirements of IPC/JEDEC J-STD-020.
- ▶ Suitable for use in SnPb or Pb-free soldering processes.

**Marking Information**

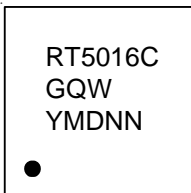

RT5016CGQW : Product Number  
YMDNN : Date Code

**Pin Configuration**

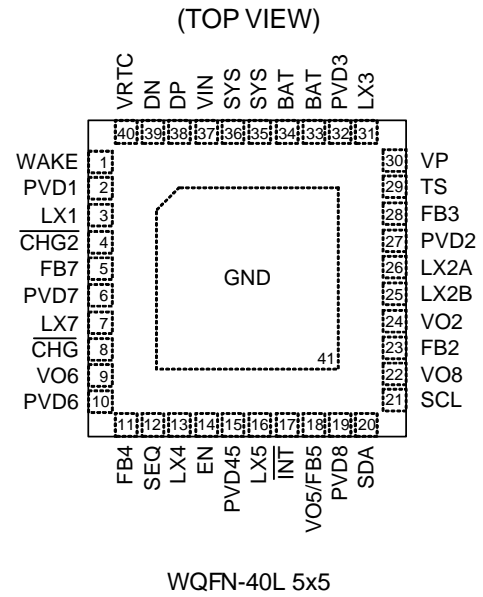

## Functional Pin Description

Pin No.	Pin Name	Pin Function
1	WAKE	Wake-up impulse push pull output. If VIN or BAT plug in, the WAKE pin generates one 90ms-width high pulse to notify micro processor.
2	PVD1	Power output of CH1. To make CH1 stable, the power path from the PVD1 pin to its output capacitors must be as short ( $\leq 1\text{mm}$ is better) and wide as possible to reduce its parasitic inductance. The output capacitor must be ceramic capacitor ( $\geq 20\mu\text{F}$ ).
3	LX1	Switch node of CH1.
4	$\overline{\text{CHG2}}$	2nd charger status indicator (Open-drain output).
5	FB7	Feedback input pin of CH7 in Step-up mode or current regulator mode
6	PVD7	Power output pin of CH7 in Step-up or power input Pin of CH7 in current regulator mode.
7	LX7	Switch node of CH7 in step-up mode. LX7 initial voltage determine CH7 operation mode.
8	$\overline{\text{CHG}}$	Charger status indicator output (Open-drain output).
9	VO6	Power output of CH6.
10	PVD6	Power input of CH6.
11	FB4	Feedback voltage input of CH4.
12	SEQ	Power sequence selection for CH1 to CH4.
13	LX4	Switch node of CH4.
14	EN	Enable control input of power converter unit.
15	PVD45	Power input of CH4 and CH5. To avoid the crosstalk between CH4 and CH5, the power path from the PVD45 pin to its input capacitors must be as short ( $\leq 1\text{mm}$ is better) and wide as possible to reduce its parasitic inductance. The input capacitance must be $\geq 10\mu\text{F}$ with low ESR.
16	LX5	Switch node of CH5.
17	$\overline{\text{INT}}$	Interrupt indicator open-drain output. If events of NoBAT, THR, EOC, battery temperature change (TS_METER), PGOOD, SAFE, $\overline{\text{VIN}}$ DPM, or charge type detection finishing (CHGRUN) happen, the output INT goes low and the $\overline{\text{INT}}$ bit in I <sup>2</sup> C register bank 0x9 is set to be "1". After INT bit is written to be "0", INT goes high.
18	VO5/FB5	Output voltage sense or feedback voltage input of CH5. The function is selected by I <sup>2</sup> C register.
19	PVD8	Power input of CH8.
20	SDA	Data signal of I <sup>2</sup> C interface.
21	SCL	Clock signal of I <sup>2</sup> C interface.
22	VO8	Power output of CH8.
23	FB2	Feedback voltage input of CH2.
24	VO2	Power output of CH2.
25	LX2B	Switch node B of CH2.
26	LX2A	Switch node A of CH2.
27	PVD2	Power input of CH2.

Pin No.	Pin Name	Pin Function
28	FB3	Feedback voltage input of CH3.
29	TS	Temperature sense input. The TS pin connects to a battery's thermistor to determine if the battery is too hot or too cold to charge. If the battery's temperature is out of range, charging is paused until it re-enters the valid range. TS also detects whether the battery (with NTC) is present or not.
30	VP	Power output of 3.3V Buffer for battery temperature sensing.
31	LX3	Switch node of CH3.
32	PVD3	Power input of CH3.
33, 34	BAT	Charger output for battery.
35, 36	SYS	Power output for system. Connect this pin to System with a minimum 10 $\mu$ F ceramic capacitor to GND.
37	VIN	Supply voltage input.
38	DP	USB D+ input for charger type detection.
39	DN	USB D- input for charger type detection.
40	VRTC	RTC LDO power output.
41 (Exposed pad)	GND	Power ground. The exposed pad must be soldered to a large PCB and connected to GND for maximum power dissipation.

Functional Block Diagram

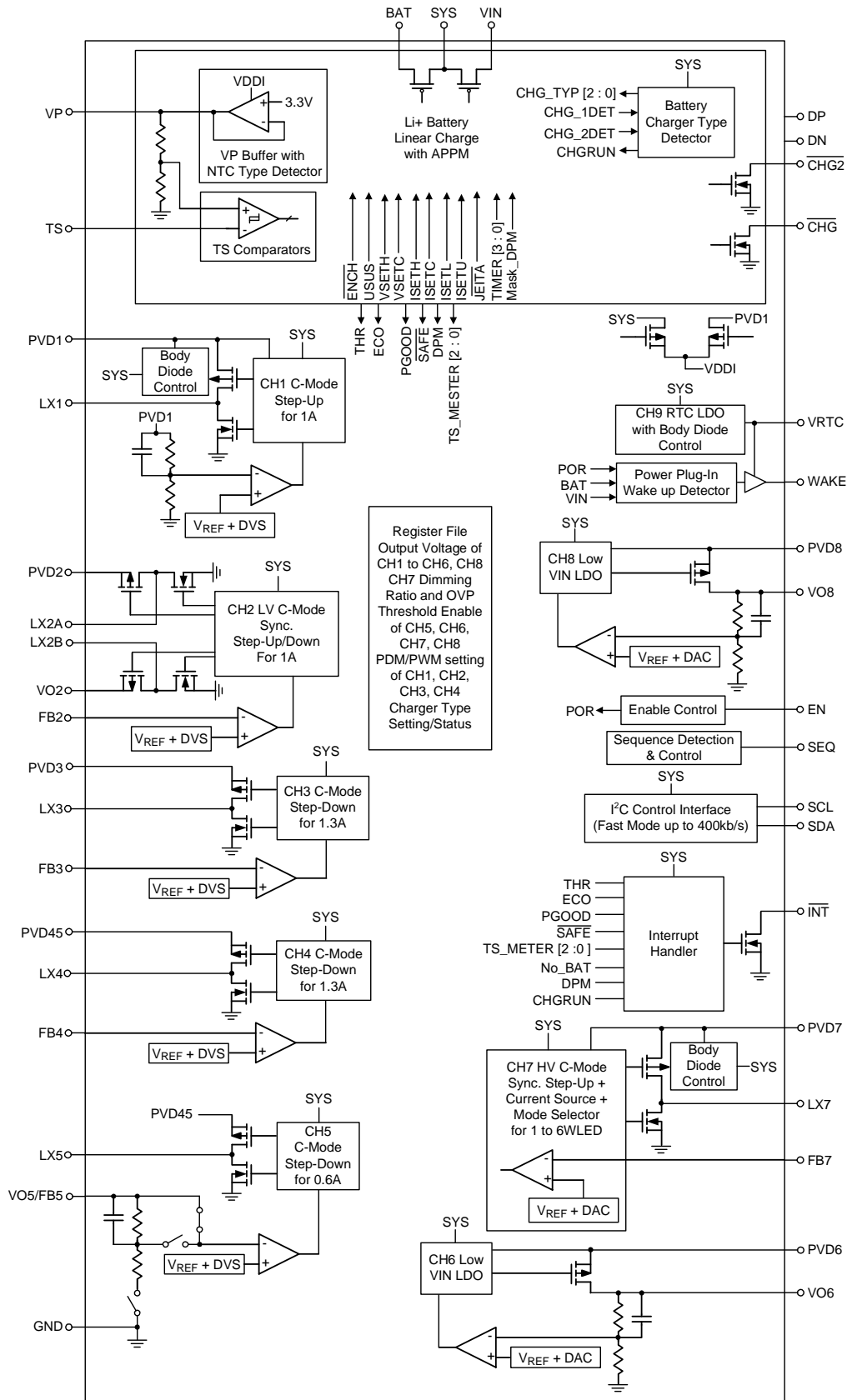

## Operation

The RT5016C is an integrated power solution for digital still cameras and other small handheld devices. It includes six DC-DC converters, a WLED driver, a RTC LDO, and a fully integrated single-cell Li-ion battery charger.

### CH1 : Step-Up DC-DC Converter

CH1 is a step-up converter for motor driver power. The converter operates at PFM or PWM current mode which can be set by I<sup>2</sup>C interface.

### CH2 : Step-Up/Down DC-DC Converter

CH2 is a step-up/down converter for I/O power. The converter operates at PFM or PWM current mode which can be set by I<sup>2</sup>C interface.

### CH3 : Step-Down DC-DC Converter

CH3 is a step-down converter for core power. The converter operates at PFM or PWM current mode which can be set by I<sup>2</sup>C interface.

### CH4 : Step-Down DC-DC Converter

CH4 is a step-down converter for memory power. The converter operates at PFM or PWM current mode which can be set by I<sup>2</sup>C interface.

### CH5 : Step-Down DC-DC Converter

CH5 is a step-down converter. The converter operates at PFM/PWM current mode.

### CH6 : Generic LDO

CH6 is a generic low voltage LDO for multiple purpose power.

### CH7 : WLED Driver

CH7 is a WLED driver that can operate in either current source mode or synchronous step-up mode which is determined by I<sup>2</sup>C interface control signal.

### CH8 : Generic LDO

CH8 is a generic low voltage LDO for multiple purpose power.

### CH9 : Keep Alive LDO and RTC

CH9 is a LDO providing a 3.05V output for real time clock.

### Charger Unit

A Li-ion battery charger with automatic power path management is designed to operate in below modes.

### Pre-Charge Mode

When the output voltage is lower than 2.8V, the charging current will be reduced to a ratio of fast-charge current set by A8.ISETA [3:0] to protect the battery life-time.

### Fast-Charge Mode

When the output voltage is higher than 3V, the charging current will be equal to the fast-charge current set by A8.ISETA [3:0].

### Constant Voltage Mode

When the output voltage is near 4.2V and the charging current falls below the termination current for a deglitch time of 25ms, the charger will be turned off and CHG will go to high.

### Re-Charge Mode

When the chip is in charge termination mode, the charging current gradually goes down to zero. Once the battery voltage drops to below 4.1V for 100ms, the charger will resume charging operation.

## Absolute Maximum Ratings (Note 1)

- Supply Voltages, SYS ----- -0.3V to 6V
- Supply Input Voltage, VIN ----- -0.3V to 28V
- Switch Node Voltage, LX1, LX2, LX3, LX4, LX5 ----- -0.3V to 6V
- PVD7, LX7 ----- -0.3V to 25V
- CHG ----- -0.3V to 28V
- CHG2 ----- -0.3V to 6V
- Other Pins ----- -0.3V to 6V
- INT, CHG, CHG2 Continuous Current ----- 20mA
- BAT Continuous Current (Total in two pins) ----- 2.5A
- Power Dissipation, P<sub>D</sub> @ T<sub>A</sub> = 25°C
  - WQFN-40L 5x5 ----- 3.63W
- Package Thermal Resistance (Note 2)
  - WQFN-40L 5x5, θ<sub>JA</sub> ----- 27.5°C/W
  - WQFN-40L 5x5, θ<sub>JC</sub> ----- 6°C/W
- Junction Temperature ----- 150°C
- Lead Temperature (Soldering, 10 sec.) ----- 260°C
- Storage Temperature Range ----- -65°C to 125°C
- ESD Susceptibility (Note 3)
  - HBM (Human Body Model) ----- 2kV
  - MM (Machine Model) ----- 200V

## Recommended Operating Conditions (Note 4)

- Supply Input Voltage, BAT ----- 1.8V to 5.5V
- Supply Input Voltage Range, VIN (A7.ISETL = 1) ----- 4.4V to 6V
- Supply Input Voltage Range, VIN (A7.ISETL = 0) ----- 4.5V to 6V
- Junction Temperature Range ----- -40°C to 125°C
- Ambient Temperature Range ----- -40°C to 85°C

## Electrical Characteristics

### Power Converter Unit :

(V<sub>SYS</sub> = 3.3V, T<sub>A</sub> = 25°C, unless otherwise specified)

Parameter	Symbol	Test Conditions	Min	Typ	Max	Unit
<b>Supply Voltage</b>						
PMU Startup Voltage at SYS	V <sub>ST</sub>	For bootstrap	1.5	--	--	V
SYS Operating Voltage for PMU	V <sub>SYS</sub>		2.7	--	5.5	V
VDDI Over Voltage Protection (OVP) (Hysteresis High)			5.82	6	6.18	V
VDDI OVP Hysteresis (Gap)			--	-0.25	--	V
VDDI UVLO (Hysteresis High)		VDDI UVLO takes effect once CH2 soft-start finish	2.2	2.4	2.6	V
VDDI UVLO Hysteresis (Gap)			--	-0.3	--	V



Parameter	Symbol	Test Conditions	Min	Typ	Max	Unit
<b>Supply Current</b>						
Shutdown Supply Current into BAT (Include I <sub>DDQ</sub> of RTC LDO)	I <sub>OFF-BAT</sub>	EN = L, and PMU off, BAT = 4.2V	--	10	20	μA
CH1 + CH2 + CH3 + CH4 Supply Current	I <sub>Q1234</sub>	Non switching, EN = 3.3V	--	--	2000	μA
CH5 Supply Current	I <sub>Q5</sub>	Non switching, A2.EN5 = 1	--	--	500	μA
CH6 Supply Current	I <sub>Q6</sub>	A2.EN6 = 1	--	--	100	μA
CH7 in Step-Up Mode Supply Current	I <sub>Q7b</sub>	Non switching, A2.EN7_DIM7 [4:0] = 5'b11111	--	--	500	μA
CH7 in Current Source mode Supply Current	I <sub>Q7c</sub>	A2.EN7_DIM7 [4:0] = 5'b11111 PVD7 = 5V	--	--	400	μA
CH8 Supply Current	I <sub>Q8</sub>	A2.EN8 = 1	--	--	100	μA
<b>Oscillator</b>						
CH1, 3, 4, 5 Operation Frequency	f <sub>OSC_1345</sub>		1800	2000	2200	kHz
CH2, 7 Operation Frequency	f <sub>OSC_27</sub>	CH7 in Step-Up mode	900	1000	1100	kHz
<b>CH1 LV Sync Step-Up</b>						
Output Voltage Accuracy at PVD1		Target voltage defined at A4.VOUT1 [3:0]	-1.5	--	1.5	%
Minimum On-Time for PSM			--	100	--	ns
Soft-Start Time		PVD1 = 0 to 5V	--	4	--	ms
Maximum Duty Cycle (Step-Up)		PVD1 < Target defined in A4.VOUT1 [3:0]	80	83	86	%
On-Resistance of MOSFET	R <sub>DS(ON)_P</sub>	P-MOSFET, PVD1 = 3.3V	--	200	300	mΩ
	R <sub>DS(ON)_N</sub>	N-MOSFET, PVD1 = 3.3V	--	150	250	mΩ
Current Limit (Step-Up)	I <sub>LIM_1</sub>		2.2	3	4	A
Over-Voltage Protection at PVD1			5.82	6	6.18	V
Under-Voltage Protection -1 at PVD1			--	SYS - 0.8	--	V
Under-Voltage Protection -2 at PVD1		Target Voltage is defined in A4.VOUT1 [3:0]	--	Target x 0.5	--	V
Over-Load Protection at PVD1		Target Voltage is defined in A4.VOUT1 [3:0]	--	Target - 0.6	--	V
Off Discharge Current at PVD1		PVD1 = 5V, SYS = 3.3V	--	20	--	mA
Discharge Finishing Threshold at PVD1			--	0.6	--	V
<b>CH2 LV Sync Step-Up/Down</b>						
Feedback Regulation Voltage at FB2		A4.FB2 [2:0] = 3'b100	0.788	0.8	0.812	V
Soft-Start Time		FB2 = 0 to 0.8V	--	4	--	ms
Maximum Duty Cycle		LX2B	--	55	--	%
		LX2A	--	--	100	%
On-Resistance of MOSFET	R <sub>DS(ON)_2A</sub>	LX2A - GND, N-MOSFET PVD2 = 3.3V	--	200	300	mΩ
		PVD2 - LX2A, P-MOSFET PVD2 = 3.3V	--	150	250	mΩ

Parameter	Symbol	Test Conditions	Min	Typ	Max	Unit
On-Resistance of MOSFET	R <sub>DSON</sub> _2B	VO2-LX2B, P-MOSFET, VO2 = 3.3V	--	200	300	mΩ
		LX2B – GND, N-MOSFET VO2 = 3.3V	--	150	250	mΩ
Current Limit	I <sub>LIM_2</sub>	Both P-MOSFET (PVD2 – LX2A) and N-MOSFET (LX2B – GND)	2	2.5	3	A
Over-Voltage Protection at VO2			5.82	6	6.18	V
Under-Voltage Protection at FB2		Target voltage is the chosen one in A4.FB2 [2:0]	--	0.4	--	V
Over-Load Protection at FB2			--	Target – 0.1	--	V
Off Discharge Current at VO2		VO2 = 3.3V, SYS = 3.3V	--	20	--	mA
Discharge Finishing Threshold at VO2			--	0.1	--	V
<b>CH3 LV Sync Step-Down</b>						
Feedback Regulation Voltage at FB3		A5.FB3 [2:0] = 3'b100	0.788	0.8	0.812	V
Minimum On-Time for PSM			--	50	--	ns
Maximum Duty Cycle		FB3 = 0.75V	--	--	100	%
Soft-Start Time		FB3 = 0 to 0.8V	--	4	--	ms
On-Resistance of MOSFET	R <sub>DSON</sub> _P	P-MOSFET, PVD3 = 3.3V	--	200	300	mΩ
	R <sub>DSON</sub> _N	N-MOSFET, PVD3 = 3.3V	--	150	250	mΩ
Current Limitation	I <sub>LIM_3</sub>		3	3.5	4	A
Under-Voltage Protection at FB3			0.35	0.4	0.45	V
Over-Load Protection at FB3		Target voltage is the chosen one in A5.FB3 [2:0]	--	Target – 0.1	--	V
Off Discharge Current at LX3		LX3 = 1V, SYS = 3.3V	--	20	--	mA
Discharge Finishing Threshold at FB3			--	0.1	--	V
<b>CH4 LV Sync Step-Down</b>						
Feedback Regulation Voltage at FB4		A5.FB4 [2:0] = 3'b100	0.788	0.8	0.812	V
Minimum On-Time for PSM			--	50	--	ns
Maximum Duty Cycle		FB4 = 0.75V	--	--	100	%
Soft-Start Time		FB4 = 0 to 0.8V	--	4	--	ms
On-Resistance of MOSFET	R <sub>DSON</sub> _P	P-MOSFET, PVD4 = 3.3V	--	300	400	mΩ
	R <sub>DSON</sub> _N	N-MOSFET, PVD4 = 3.3V	--	200	300	mΩ
Current Limit	I <sub>LIM_4</sub>		2	2.5	3	A
Under-Voltage Protection at FB4			0.35	0.4	0.45	V
Over-Load Protection at FB4		Target voltage is the chosen one in A5.FB4 [2:0]	--	Target – 0.1	--	V
Off Discharge Current at LX4		LX4 = 1V, SYS = 3.3V	--	20	--	mA
Discharge Finishing Threshold at FB4			--	0.1	--	V

Parameter	Symbol	Test Conditions	Min	Typ	Max	Unit
<b>CH5 LV Sync Step-Down</b>						
Output Voltage Accuracy at VO5		Target voltage defined at A6.VOUT5 [3:0] = 4'b1000 to 4'b1111	-1.5	--	1.5	%
		Target voltage defined at A6.VOUT5 [3:0] = 4'b0001 to 4'b0111	-2	--	2	%
Feedback Regulation Voltage at FB5		A6.VOUT5 [3:0] = 4'b0000	0.788	0.8	0.812	V
Maximum Duty Cycle			--	--	100	%
Soft-Start Time		VO5 = 0V to Target	--	4	--	ms
On-Resistance of MOSFET	R <sub>DS(ON)_P</sub>	P-MOSFET, PVD5 = 3.3V	--	400	550	mΩ
	R <sub>DS(ON)_N</sub>	N-MOSFET, PVD5 = 3.3V	--	250	400	mΩ
Current Limit	I <sub>LIM_5</sub>		1	1.5	2	A
Under-Voltage Protection at VO5			--	Target x 0.5	--	
Over-Load Protection at VO5		Target voltage is the chosen one in A6.VOUT5 [3:0] = 0000 (FB5 = 0.8)	--	Target - 0.1	--	V
		Target voltage is the chosen one in A6.VOUT5 [3:0] = 0001 to 0111	--	Target - 0.167	--	
		Target voltage is the chosen one in A6.VOUT5 [3:0] = 0111 to 1111	--	Target - 0.25	--	
Off Discharge Current at VO5		VO5 = 1.8V, SYS = 3.3V	--	30	--	mA
Discharge Finishing Threshold at VO5			--	0.1	--	V
<b>CH6 LDO</b>						
Input Voltage Range (PVD6)			1.5	--	5.5	V
Quiescent Current into PVD6		PVD6 = 3.3V, I <sub>OUT</sub> = 0mA	--	--	75	μA
Regulation Voltage Accuracy at VO6		A6.VOUT6 [3:0] = 4'b1000 to 4'b1111	-1.5	--	1.5	%
		A6.VOUT6 [3:0] = 4'b0000 to 4'b0111	-2	--	2	%
Drop Out Voltage (PVD6-VO6)		I <sub>OUT</sub> = 300mA, VO6 = 1.3V	--	--	0.15	V
PSRR+		I <sub>OUT</sub> = 10mA, PVD6 = 3.3V at 1kHz	--	-60	--	dB
Max Output Current (Current Limit)		PVD6 = 1.5V, VO6 = 1.3V	300	450	600	mA
Off Discharge Current at VO6		SYS = 3.3V	--	--	10	mA
<b>CH7 WLED Driver</b>						
Feedback Regulation Voltage at FB7 (Both Step-Up and Current)		A2.EN7_DIM7 [4:0] = 5'b11111	0.237	0.25	0.263	V
Minimum On-Time for PSM (Step-Up)			--	300	--	ns
Maximum Duty Cycle (Step-Up mode)		FB7 = 0.15V	91	93	97	%

Parameter	Symbol	Test Conditions	Min	Typ	Max	Unit
On-Resistance of MOSFET	R <sub>DS(ON)_P</sub>	P-MOSFET, PVD7 = 10V	--	2	3	Ω
	R <sub>DS(ON)_N</sub>	N-MOSFET, SYS = 3.3V	--	0.9	1.1	Ω
Current Limit (Step-Up mode)		N-MOSFET, SYS = 3.3V	0.6	0.8	1	A
Over-Voltage Protection at PVD7 (Step-Up mode)		A0.OVP7 = 0	15	16	17	V
		A0.OVP7 = 1	24	25	26	V
Off Discharge Current at PVD7 (Step-Up mode)		PVD7 = 10V, SYS = 3.3V	--	20	--	mA
Discharge Finishing Threshold at PVD7		(Step-Up Mode)	--	SYS - 0.4	--	V
<b>CH8 LDO</b>						
Input Voltage Range (PVD8)			1.5	--	5.5	V
Quiescent Current into PVD8	I <sub>Q_PVD8</sub>	PVD8 = 3.3V, I <sub>OUT</sub> = 0mA	--	--	75	μA
Regulation Voltage Accuracy at VO8		A3.VOUT8 [3:0] = 4'b1000 to 4'b1111	-1.5	--	1.5	%
		A3.VOUT8 [3:0] = 4'b0000 to 4'b0111	-2	--	2	%
Drop Out Voltage (PVD8-VO8)		I <sub>OUT</sub> = 300mA, VO8 = 2.5V	--	--	0.2	V
PSRR+		I <sub>OUT</sub> = 10mA, PVD8 = 3.3V at 1kHz	--	-60	--	dB
Max Output Current (Current Limit)		PVD8 = 3V, VO8 = 2.5V	300	450	600	mA
Off Discharge Current at VO8		SYS = 3.3V	--	--	10	mA
<b>CH9 RTC LDO</b>						
Standby Quiescent Current		BAT = 4.2V	--	3	6	μA
Lockout Current into VRTC	I <sub>LO-VRTC</sub>	EN = L, and PMU off, BAT = 0V, VRTC = 3.05V, SYS = 0V	--	--	1	μA
Regulation Voltage at VRTC		I <sub>OUT</sub> = 0mA	3	3.05	3.1	V
Max Output Current (Current Limit)		BAT = 4.2V	60	130	200	mA
Dropout Voltage at (BAT-VRTC)		I <sub>OUT</sub> = 50mA	--	--	1000	mV
		I <sub>OUT</sub> = 10mA	--	--	150	mV
		I <sub>OUT</sub> = 3mA	--	--	60	mV
<b>Wake Up Detector</b>						
WAKE Impulse High Duration	t <sub>WAKEUP</sub>	VIN or BAT plug in, VRTC = 3.05V	60	90	120	ms
WAKE Output Voltage	High-Level	V <sub>WAKE_H</sub>	--	VRTC - 0.3V	VRTC	V
	Low-Level	V <sub>WAKE_L</sub>	0	0.3	--	V
WAKE Rising Time	t <sub>WAKE_R</sub>	C <sub>LOAD</sub> = 100pF at WAKE pin, 10% to 90% of VRTC, VRTC = 3.05V	--	--	1	μs
BAT Wake Up Threshold Voltage		VRTC = 3.05V	3	3.1	3.2	V
BAT Wake Up Threshold Hysteresis		VRTC = 3.05V	--	-0.28	--	V

Parameter	Symbol	Test Conditions	Min	Typ	Max	Unit
VIN Wake Up Threshold Voltage		VRTC = 3.05V	3.55	3.75	4	V
VIN Wake Up Threshold Hysteresis		VRTC = 3.05V	--	-0.24	--	V
<b>Control</b>						
EN Input Threshold	High-Level		1.3	--	--	V
	Low-Level		--	--	0.4	V
EN Pull Down Current			--	1	3	μA
SEQ Pull High Threshold for Power Sequence #0			0.2	--	--	V
SEQ Pull Down Resistance for Power Sequence #1		BAT = SYS = 2.7V	25	40	64	kΩ
SEQ Pull Down Resistance for Power Sequence #2		BAT = SYS = 2.7V	6.25	10	16	kΩ
SEQ Pull Down Resistance for Power Sequence #3		BAT = SYS = 2.7V	1.56	2.5	4	kΩ
SEQ Pull Down Resistance for Power Sequence #4		BAT = SYS = 2.7V	--	0.63	1	kΩ
SEQ Pull Low Threshold for Power Sequence #4			--	--	0.2	V
SEQ Pull Down Resistance for Power Sequence #5		BAT = SYS = 2.7V	100	160	--	kΩ
Power Sequence Time Gap		From previous channel starting to next channel starting	9	10	11	ms
<b>Protection</b>						
Protection Fault Delay			--	100	--	ms
Thermal Shutdown	T <sub>SD</sub>		125	155	--	°C
Thermal Shutdown Hysteresis	ΔT <sub>SD</sub>		--	20	--	°C

### Charger Unit :

( $V_{IN} = 5V$ ,  $V_{BAT} = 4V$ ,  $T_A = 25^\circ C$ , unless otherwise specified)

Parameter	Symbol	Test Conditions	Min	Typ	Max	Unit
<b>Supply Input</b>						
VIN Under-Voltage Lockout Threshold	$V_{UVLO}$	$V_{IN} = 0V$ to 4.5V	3.1	3.3	3.5	V
VIN Under-Voltage Lockout Hysteresis	$\Delta V_{UVLO}$	$V_{IN} = 4.5V$ to 0V	--	240	--	mV
VIN Supply Current	$I_{SUPPLY}$	$I_{SYS} = I_{BAT} = 0mA$ , A7.ENCH = 0 ( $V_{BAT} > V_{REGx}$ )	--	1	2	mA
		$I_{SYS} = I_{BAT} = 0mA$ , A7.ENCH = 1 ( $V_{BAT} > V_{REGx}$ )	--	0.8	1.5	mA
VIN Suspend Current	$I_{USUS}$	$V_{IN} = 5V$ , A7.USUS = 1	--	195	300	$\mu A$
VIN-BAT VOS Rising	$V_{OS\_H}$		--	200	300	mV
VIN-BAT VOS Falling	$V_{OS\_L}$		10	50	--	mV
<b>Voltage Regulation</b>						
System Regulation Voltage	$V_{SYS}$	$I_{SYS} = 800mA$ , $V_{IN} = 5.5V$	4.9	5	5.1	V
Battery Regulation Voltage	$V_{REG1}$	0 to 85°C, Loading = 20mA, When A9.VSETH = 1 and A9.VSETC = 1	4.16	4.2	4.23	V
Battery Regulation Voltage	$V_{REG2}$	0 to 85°C, Loading = 20mA, When A9.VSETH = 0 and A9.VSETC = 0	4.01	4.05	4.08	V
APPM Regulation Voltage	$V_{APPM}$		4.05	4.15	4.25	V
DPM Regulation Voltage	$V_{DPM}$		4.25	4.35	4.45	V
VIN to VSYS MOSFET Ron	$R_{DS(ON)}$	$I_{VIN} = 1000mA$	--	0.2	0.35	$\Omega$
BAT to VSYS MOSFET Ron	$R_{DS(ON)}$	$V_{BAT} = 4.2V$ , $I_{SYS} = 1A$	--	0.05	0.1	$\Omega$
Re-Charge Threshold	$\Delta V_{REGCHG}$	Battery Regulation - Recharge level	60	100	140	mV
<b>Current Regulation</b>						
Charge Current Setting Range	$I_{CHG}$		100	--	1200	mA
Charge Current Accuracy1	$I_{CHG1}$	$V_{BAT} = 4V$ , A8.ISETA [3 : 0] = 4'b0101	570	600	630	mA
Charge Current Accuracy2	$I_{CHG2}$	$V_{BAT} = 3.8V$ , A8.ISETA [3 : 0] = 4'b0010	285	300	315	mA
VIN Current Limit	$I_{LIM\_VIN}$	A7.ISETL = 1, A7.ISETU = 1 (1.5A Mode)	1.5	1.8	2.1	A
		A7.ISETL = 1, A7.ISETU = 0 (1A Mode)	0.85	0.925	1.0	A
		A7.ISETL = 0, A7.ISETU = 1 (500mA mode)	450	475	500	mA
		A7.ISETL = 0, A7.ISETU = 0 (100mA Mode)	80	85	90	mA
<b>Pre-Charge</b>						
BAT Pre-Charge Threshold	$V_{PRECH}$	BAT Falling	2.7	2.8	2.9	V
BAT Pre-Charge Threshold Hysteresis	$\Delta V_{PRECH}$		--	200	--	mV
Pre-Charge Current	$I_{CHG\_PRE}$	$V_{BAT} = 2V$	5	10	15	%

Parameter	Symbol	Test Conditions	Min	Typ	Max	Unit
<b>Charge Termination Detection</b>						
Termination Current Ratio to Fast Charge (Except USB 100 Mode)	$I_{TERM}$	A7.ISETL = 0, A7.ISETU = 1 Or A7.ISETL = 1, A7.ISETU = X	5	10	15	%
Termination Current Ratio to Fast Charge (USB100 Mode)	$I_{TERM2}$	A7.ISETL = 0, A7.ISETU = 0	--	3.3	--	%
<b>Login Input/Output</b>						
$\overline{CHG}$ Pull Down Voltage	$V_{\overline{CHG}}$	$I_{\overline{CHG}} = 5mA$	--	200	--	mV
$\overline{CHG2}$ Pull Down Voltage	$V_{\overline{CHG2}}$	$I_{\overline{CHG2}} = 5mA$	--	200	--	mV
$\overline{INT}$ Pull Down Voltage	$V_{\overline{INT}}$	$I_{\overline{INT}} = 5mA$	--	200	--	mV
<b>Protection</b>						
Thermal Regulation Point	$T_{REG}$		--	125	--	°C
Thermal Shutdown Temperature	$T_{SD}$		--	155	--	°C
Thermal Shutdown Hysteresis	$\Delta T_{SD}$		--	20	--	°C
Over-Voltage Protection	$V_{OVP}$	$V_{IN}$ Rising	6.25	6.5	6.75	V
Over-Voltage Protection Hysteresis	$\Delta V_{OVP}$	$V_{IN} = 7V$ to $5V$ , $V_{OVP} - \Delta V_{OVP}$	--	100	--	mV
Output Short Circuit Detection Threshold	$V_{SHORT}$	$V_{BAT} - V_{SYS}$	--	300	--	mV
Battery Installation Detection Threshold at TS		EN = H (PMU enabled), report at A10. NoBAT bit	--	90	--	% of VP
<b>Time</b>						
Input Over-Voltage Blanking Time	$t_{OVP}$		--	50	--	$\mu s$
Pre-Charge to Fast-Charge Deglitch Time	$t_{PF}$		--	25	--	ms
Fast-Charge to Pre-Charge Deglitch Time	$t_{FP}$		--	25	--	ms
Termination Deglitch Time	$t_{TERMI}$		--	25	--	ms
Recharge Deglitch Time	$t_{RECHG}$		--	100	--	ms
Input Power Loss to SYS LDO Turn-Off Delay Time	$t_{NO\_IN}$		--	25	--	ms
Pack Temperature Fault Detection Deglitch Time	$t_{TS}$		--	25	--	ms
Short-Circuit Deglitch Time	$t_{SHORT}$		--	250	--	$\mu s$
Short-Circuit Recovery Time	$t_{SHORT-R}$		--	64	--	ms
<b>Other</b>						
VP Regulation Voltage	$V_{VP}$	$V_{SYS} = 4.2V$	3.234	3.3	3.366	V
VP Load Regulation	$V_{VP}$	VP source out 2mA	--	--	-0.1	V

Parameter	Symbol	Test Conditions	Min	Typ	Max	Unit
VP Under-Voltage Lockout Threshold		Falling Threshold	--	0.8	--	V
TS Battery Detect Threshold	V <sub>TS</sub>		2.75	2.85	2.95	V
<b>NTC Temperature Sense</b>						
Low Temperature Trip Point (0°C)	V <sub>TOO_COLD</sub>	NTC = 100kΩ	73	74	75	% of VP
	V <sub>TOO_COLD</sub>	NTC = 10kΩ	59	60	61	% of VP
Low Temperature Trip Point (10°C) for JEITA	V <sub>COLD</sub>	NTC = 100kΩ	63	64	65	% of VP
	V <sub>COLD</sub>	NTC = 10kΩ	51	52	53	% of VP
High Temperature Trip Point (45°C) for JEITA	V <sub>HOT</sub>	NTC = 100kΩ	34	35	36	% of VP
	V <sub>HOT</sub>	NTC = 10kΩ	31	32	33	% of VP
High Temperature Trip Point (60°C)	V <sub>TOO_HOT</sub>	NTC = 100kΩ, A8.TSHT [1:0] = 2'b00	27	28	29	% of VP
	V <sub>TOO_HOT</sub>	NTC = 10kΩ, A8.TSHT [1:0] = 2'b00	27	28	29	% of VP
High Temperature Trip Point Hysteresis for JEITA			--	1	--	% of VP
<b>Charger Detection</b>						
VDP_SRC Voltage	VDP_SRC	With IDAT_SRC = 0 to 200μA	0.5	--	0.7	V
VDAT_REF Voltage	VDAT_REF		0.25	--	0.4	V
VLGC Voltage	VLGC		0.8	--	2.0	V
IDP_SRC Current	IDP_SRC		6.6	--	11	μA
D+ and D- Sink Current	ICD+_SINK ICD-_SINK		50	--	150	μA
D- Pull down Resistor	RD-_DWN		14.25	--	24.8	kΩ
Data Contact Detect Debounce	TDCD_DBNC		10	15	20	ms
DCD Time OUT	TDCD_TO		150	--	450	ms
VDAT_SRC ON Time	TDP_SRC_ON		50	--	100	ms



(V<sub>sys</sub> = 3.3V, T<sub>A</sub> = 25°C, unless otherwise specified)

Parameter	Symbol	Test Conditions	Min	Typ	Max	Unit
<b>I<sup>2</sup>C</b>						
SDA, SCLK Input Voltage	High Level		1.4	--	--	V
	Low Level		--	--	0.6	
SCLK Clock Rate	f <sub>SCL</sub>		--	--	400	kHz
Hold Time (repeated) START Condition. After this period, the first clock pulse is generated.	t <sub>HD,STA</sub>		0.6	--	--	μs
LOW Period of the SCL Clock	t <sub>LOW</sub>		1.3	--	--	μs
HIGH Period of the SCL Clock	t <sub>HIGH</sub>		0.6	--	--	μs
Set-Up Time for a Repeated START Condition	t <sub>SU,STA</sub>		0.6	--	--	μs
Data Hold Time	t <sub>HD,DAT</sub>		0	--	0.9	μs
Data Set-Up Time	t <sub>SU,DAT</sub>		100	--	--	ns
Set-Up Time for STOP Condition	t <sub>SU,STO</sub>		0.6	--	--	μs
Bus Free Time between a STOP and START condition	t <sub>BUF</sub>		1.3	--	--	μs
Rise time of both SDA and SCL signals	t <sub>R</sub>		20	--	300	ns
Fall Time of Both SDA and SCL Signals	t <sub>F</sub>		20	--	300	ns
SDA and SCL Output Low Sink Current	I <sub>OL</sub>	SDA or SCL voltage = 0.4V	2	--	--	mA

**Note 1.** Stresses beyond those listed “Absolute Maximum Ratings” may cause permanent damage to the device. These are stress ratings only, and functional operation of the device at these or any other conditions beyond those indicated in the operational sections of the specifications is not implied. Exposure to absolute maximum rating conditions may affect device reliability.

**Note 2.** θ<sub>JA</sub> is measured at T<sub>A</sub> = 25°C on a high effective thermal conductivity four-layer test board per JEDEC 51-7. θ<sub>JC</sub> is measured at the exposed pad of the package.

**Note 3.** Devices are ESD sensitive. Handling precaution is recommended.

**Note 4.** The device is not guaranteed to function outside its operating conditions.

## Typical Application Circuit

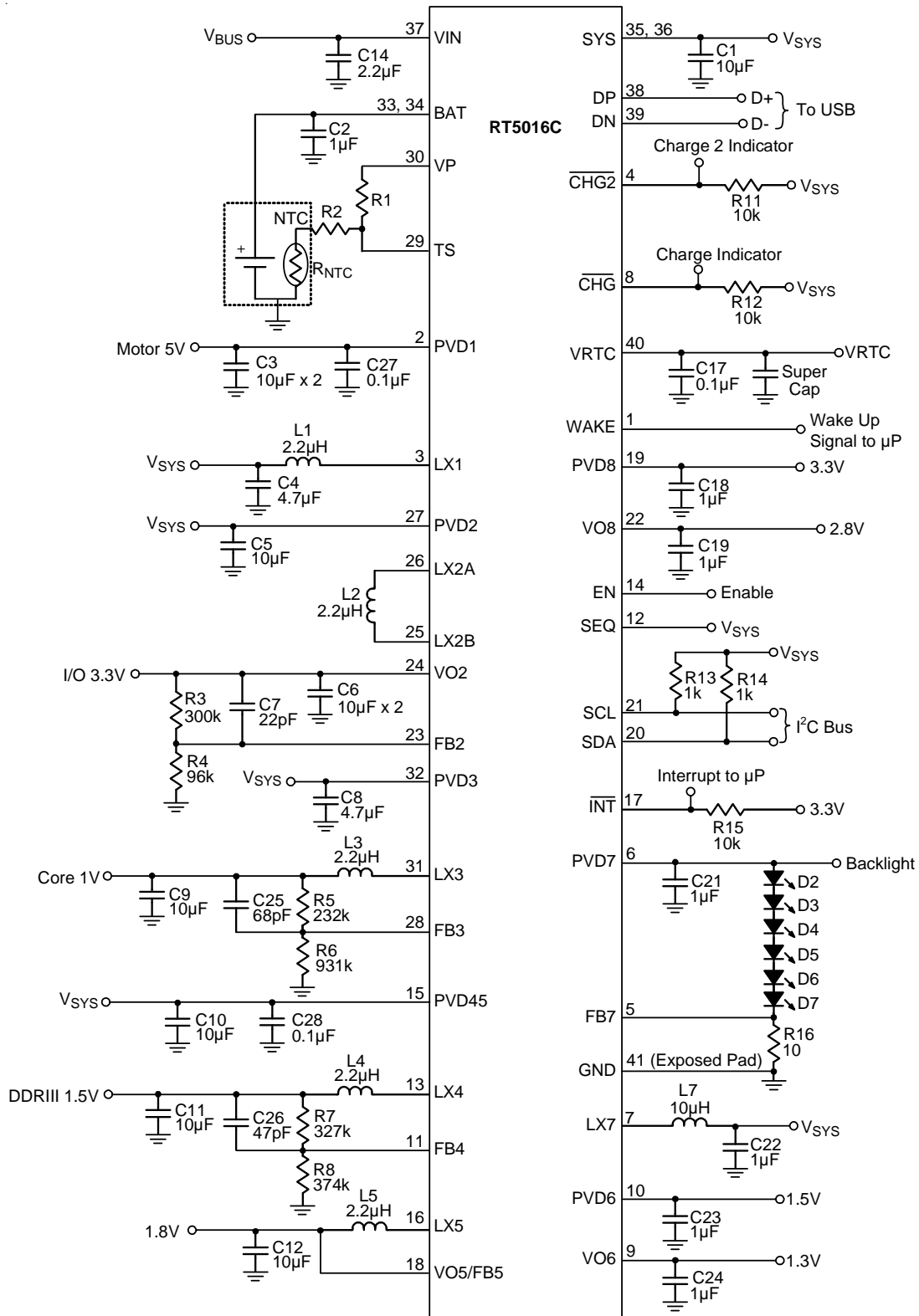

Note : To make CH1 stable, C27 must be close to PVD1. To make CH4 and CH5 stable, C28 must be close to PVD45.

Figure 1. Typical Application Circuit for DSC with 6-LED Backlight

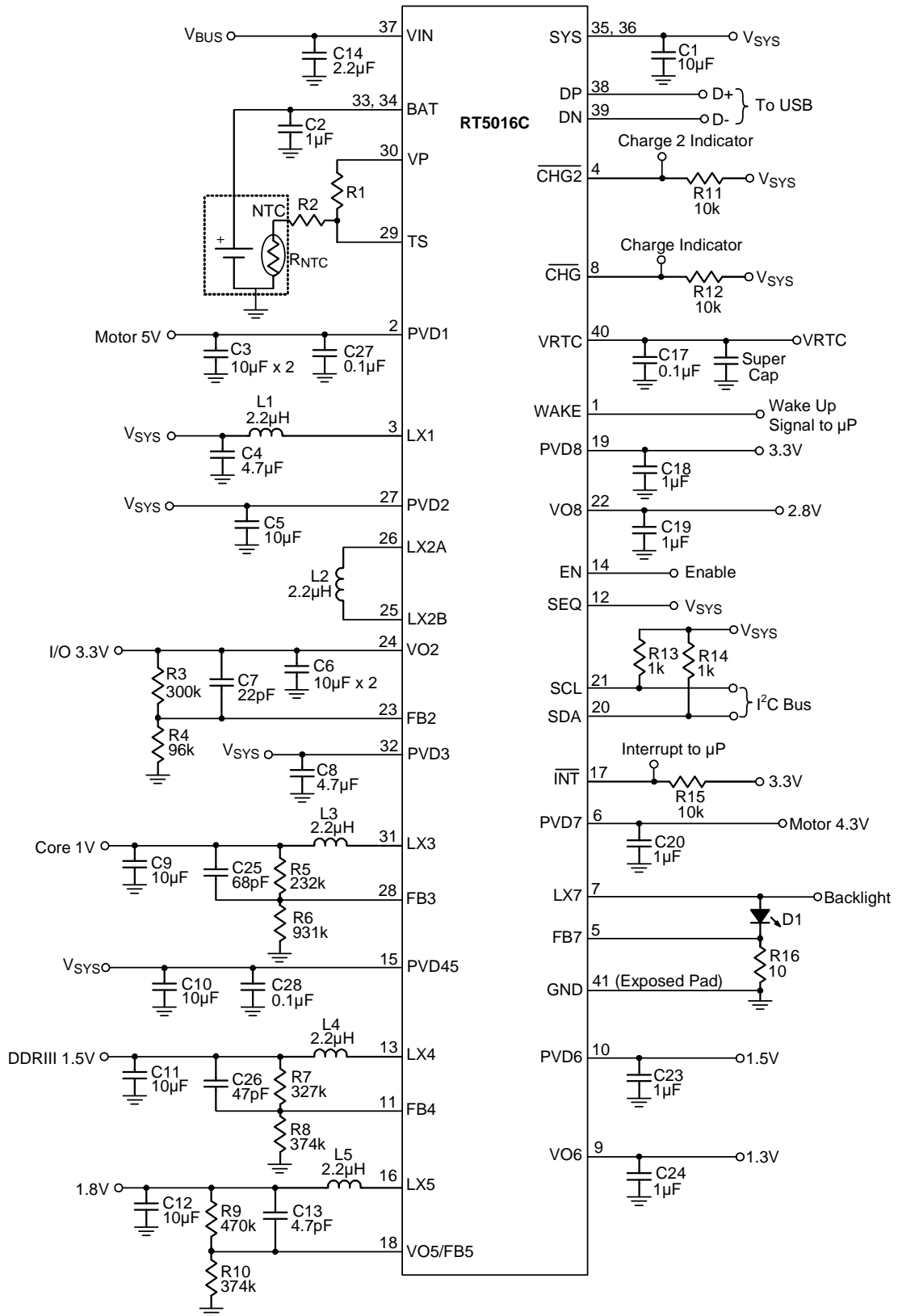

Note : To make CH1 stable, C27 must be close to PVD1. To make CH4 and CH5 stable, C28 must be close to PVD45.

Figure 2. Typical Application Circuit for DSC with One LED Backlight

## Typical Operating Characteristics

$V_{IN} = 5V$ , unless otherwise specified.

### CH1 Step-Up Efficiency vs. Output Current

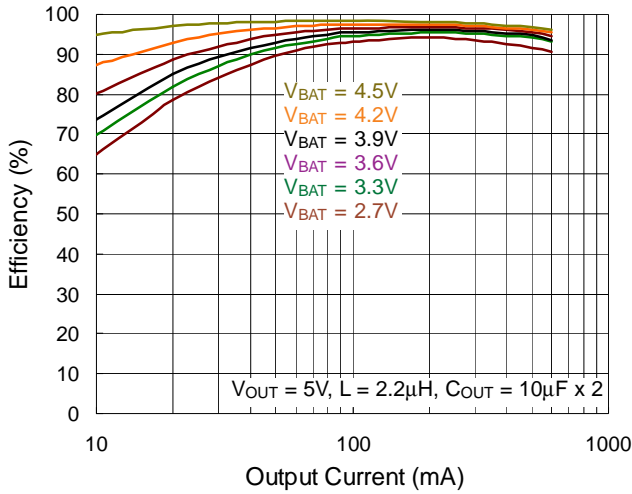

### CH2 Step-Up/Down Efficiency vs. Output Current

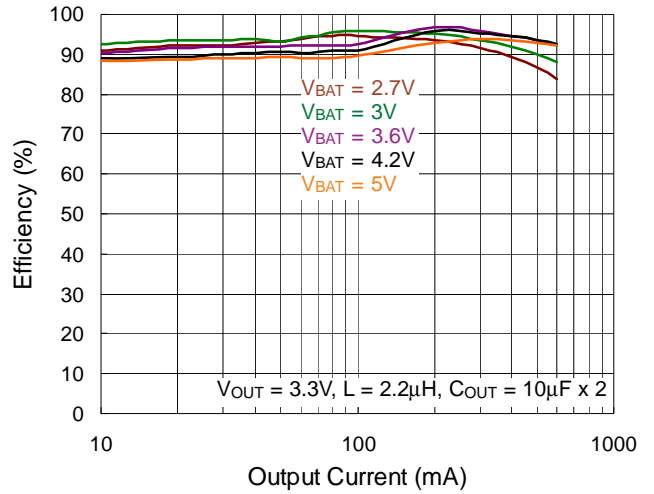

### CH3 Step-Down Efficiency vs. Output Current

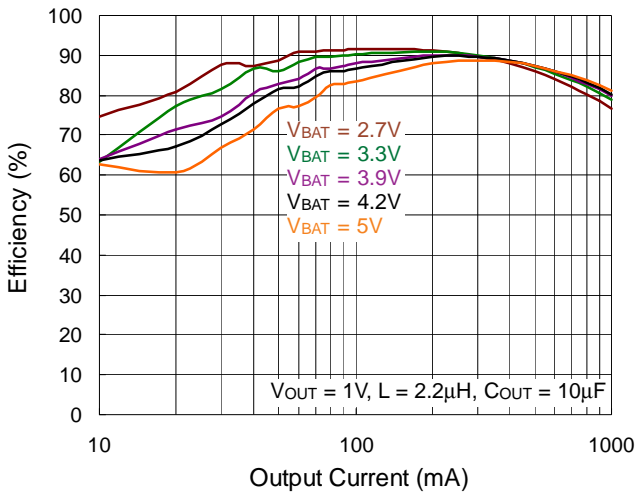

### CH4 Step-Down Efficiency vs. Output Current

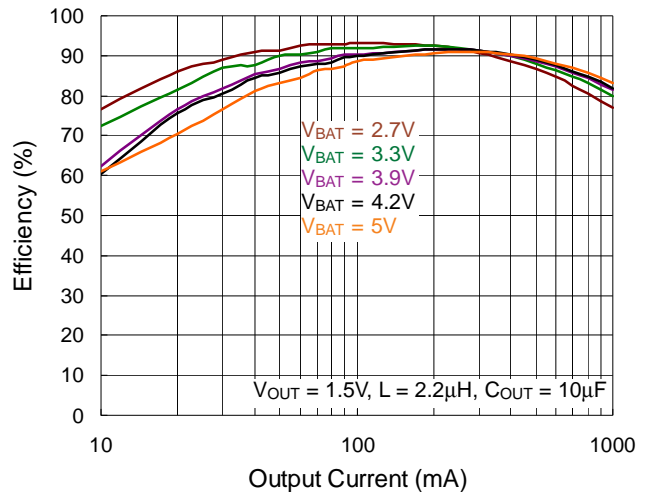

### CH5 Step-Down Efficiency vs. Output Current

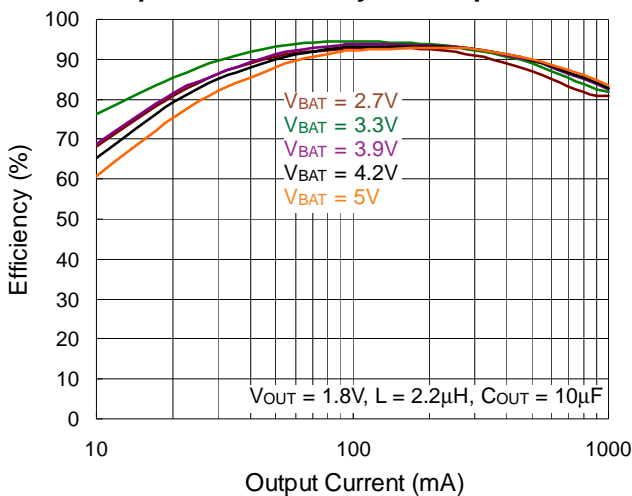

### CH7 Efficiency vs. Input Voltage

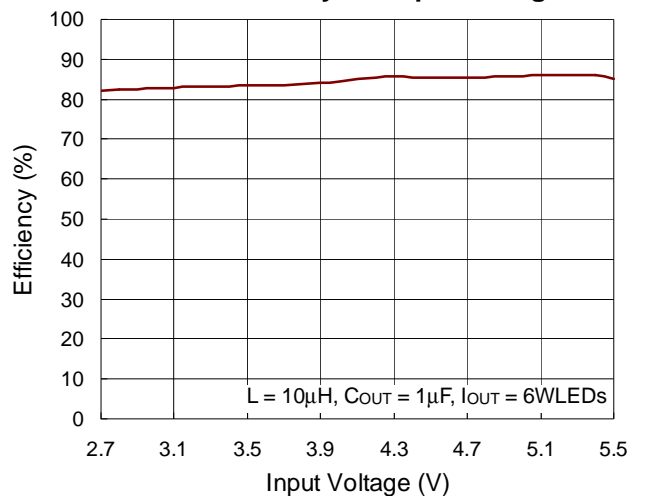

**CH1 Step-Up Output Voltage vs. Output Current**

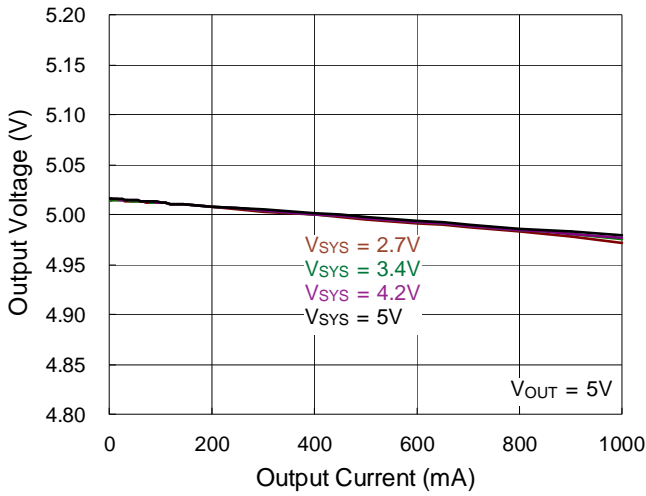

**CH2 Step-Up/Down Output Voltage vs. Output Current**

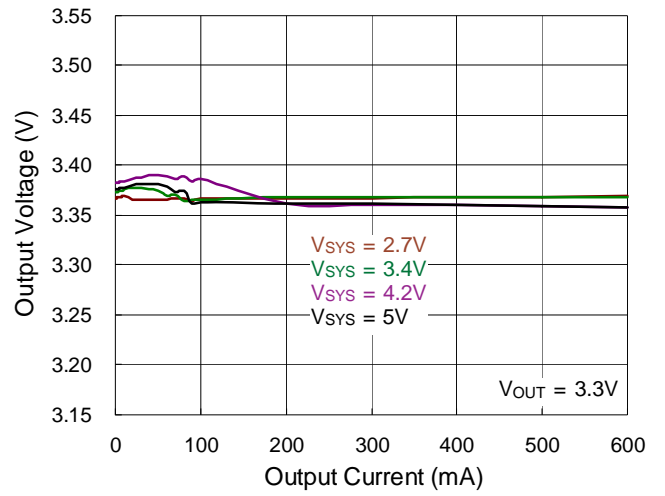

**CH3 Step-Down Output Voltage vs. Output Current**

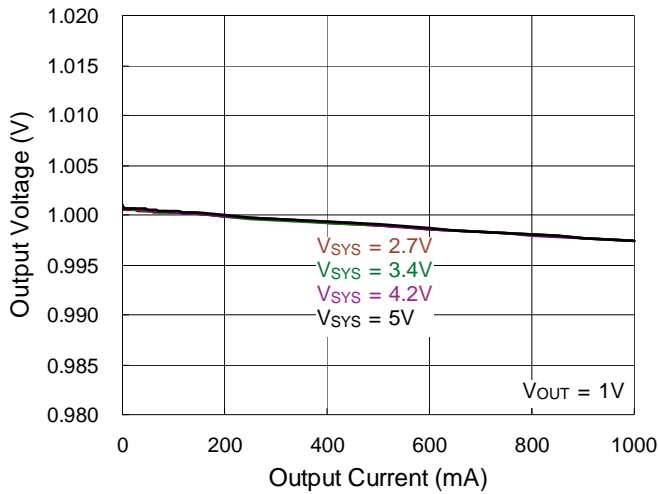

**CH4 Step-Down Output Voltage vs. Output Current**

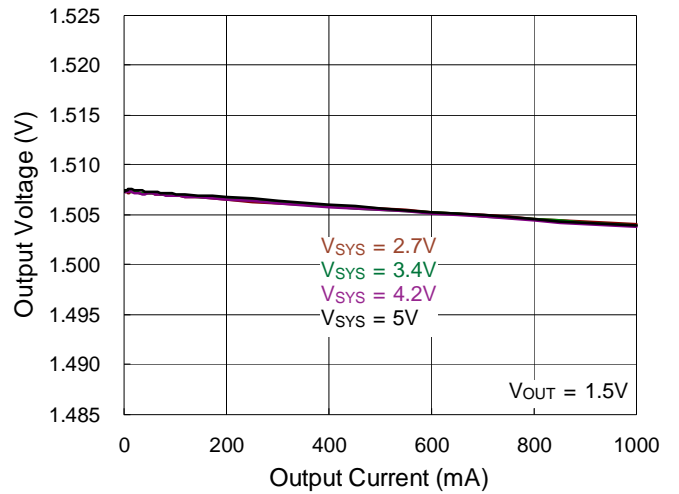

**CH5 Step-Down Output Voltage vs. Output Current**

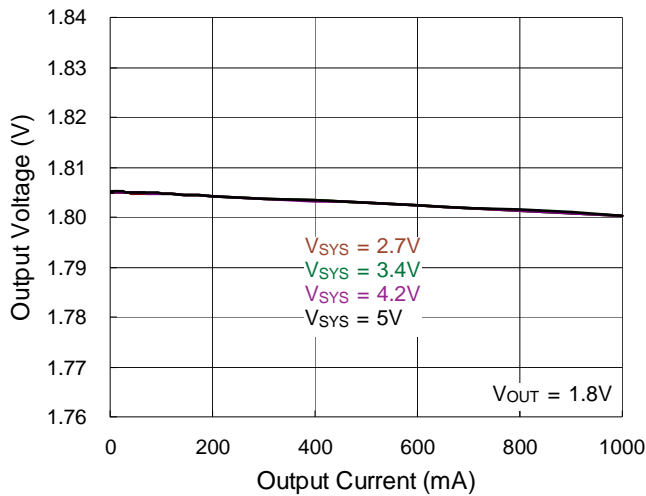

**CH6 LDO Output Voltage vs. Output Current**

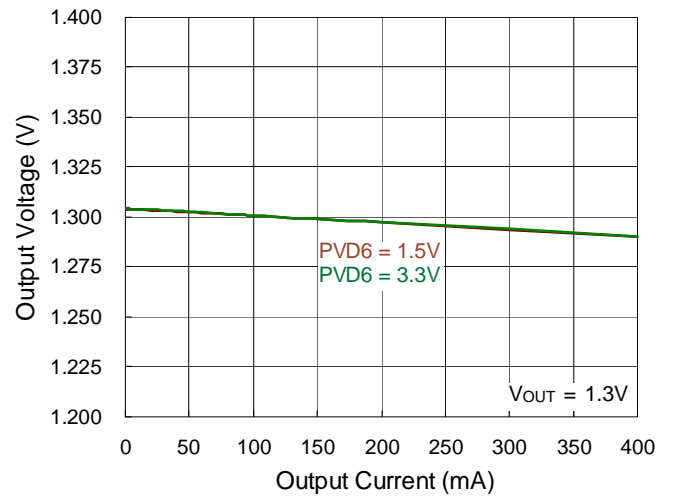

### CH8 LDO Output Voltage vs. Output Current

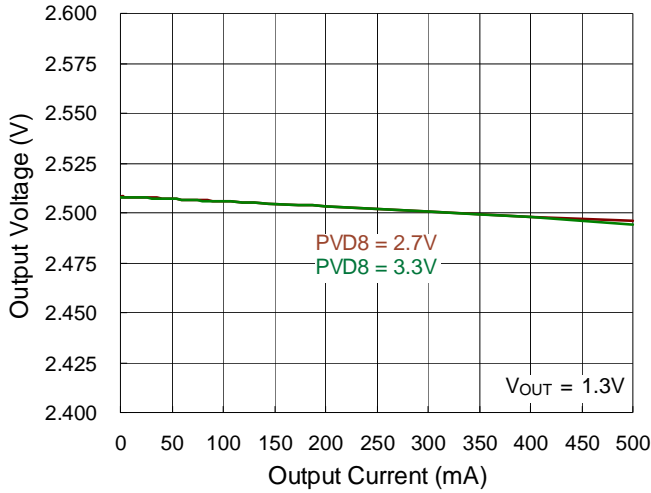

### CH1 Output Voltage Ripple

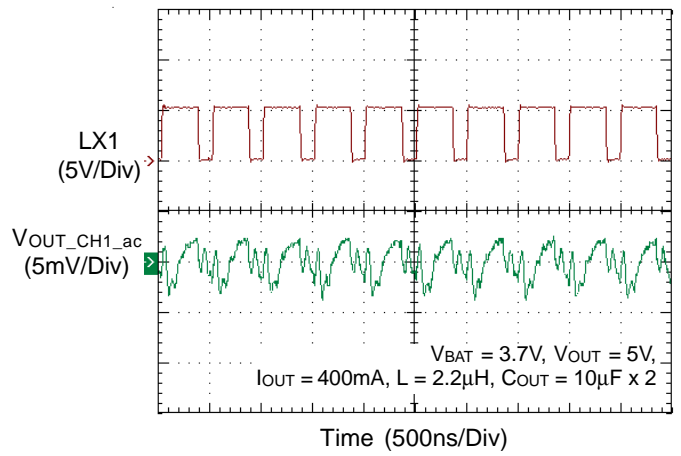

### CH2 Output Voltage Ripple

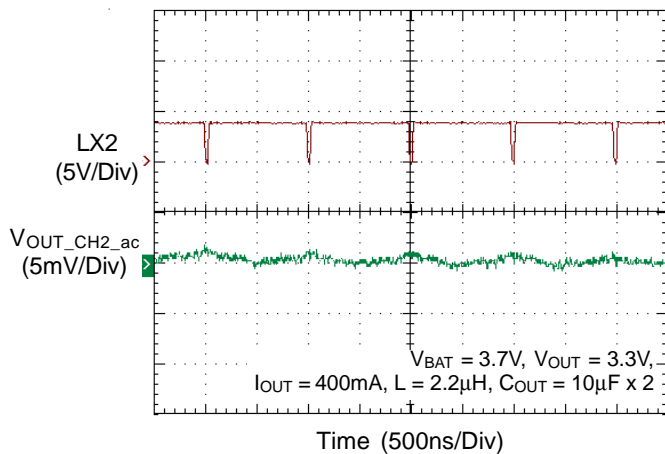

### CH3 Output Voltage Ripple

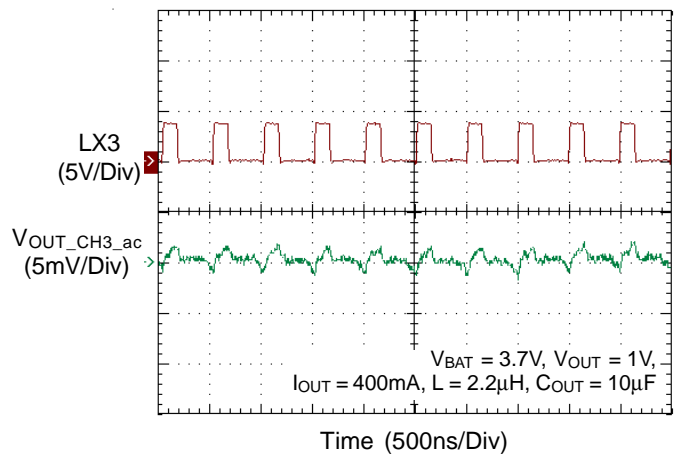

### CH4 Output Voltage Ripple

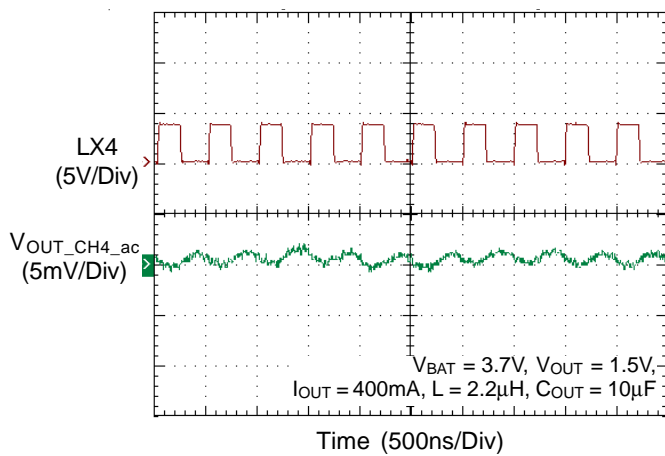

### CH5 Output Voltage Ripple

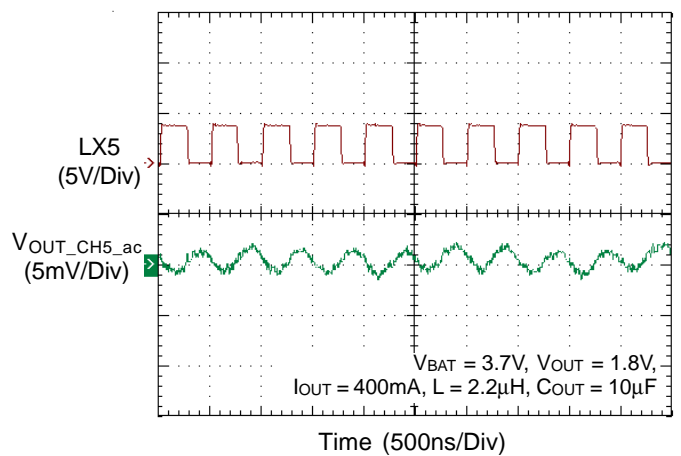

**CH1 Load Transient Response**

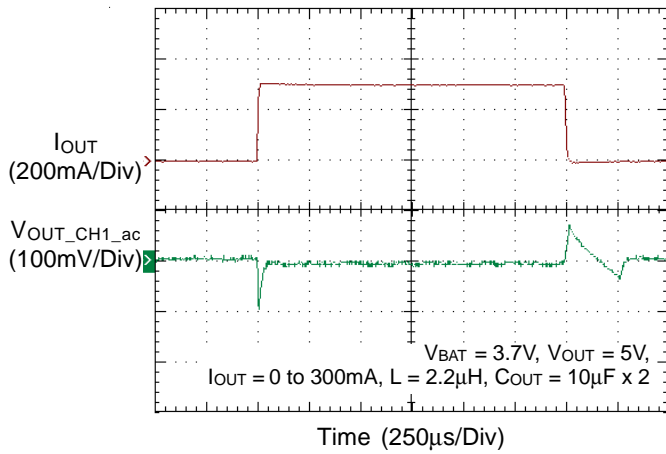

**CH2 Load Transient Response**

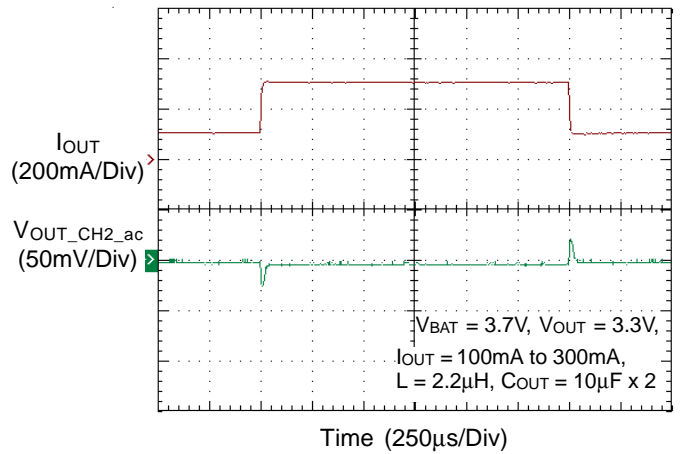

**CH3 Load Transient Response**

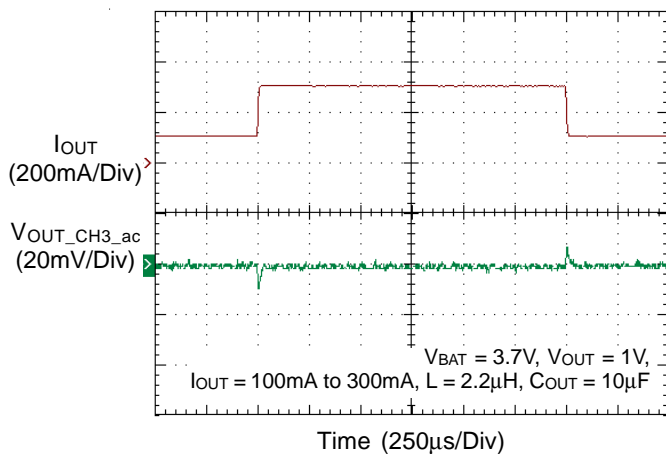

**CH4 Load Transient Response**

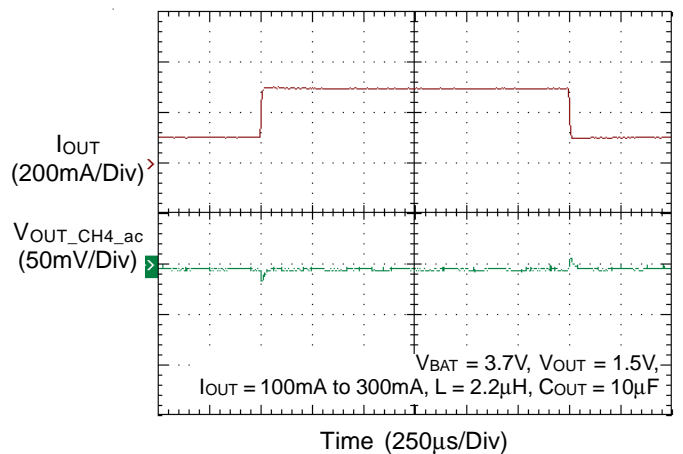

**CH5 Load Transient Response**

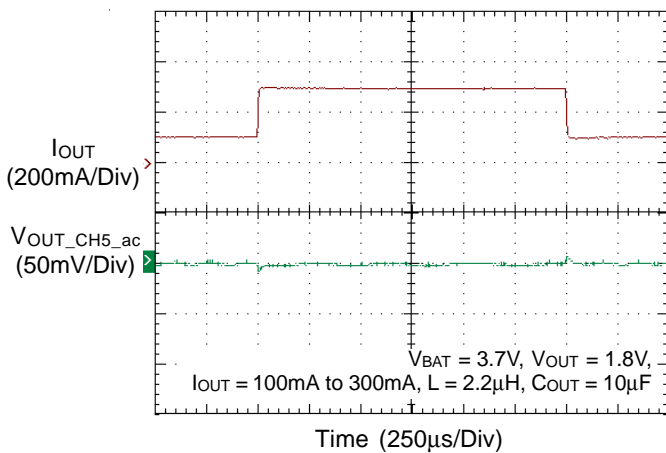

**CH6 Load Transient Response**

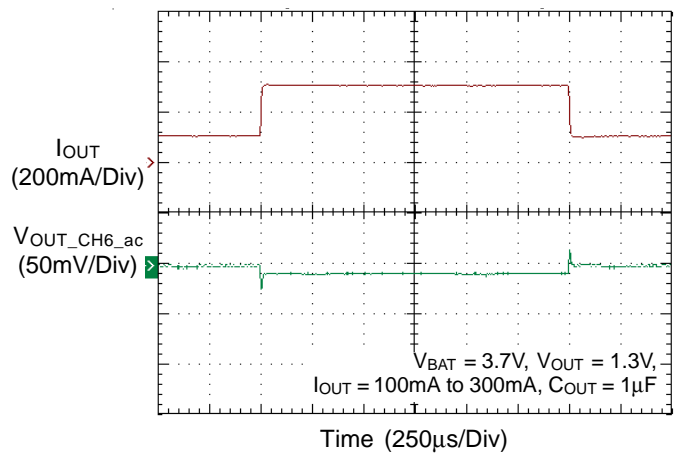

CH8 Load Transient Response

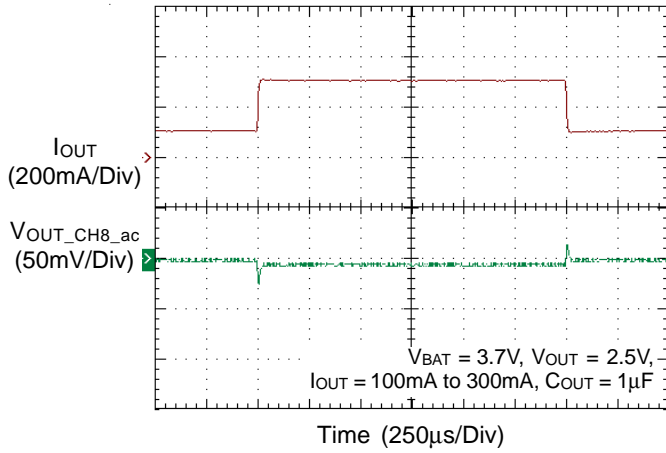

Power On Sequence 0

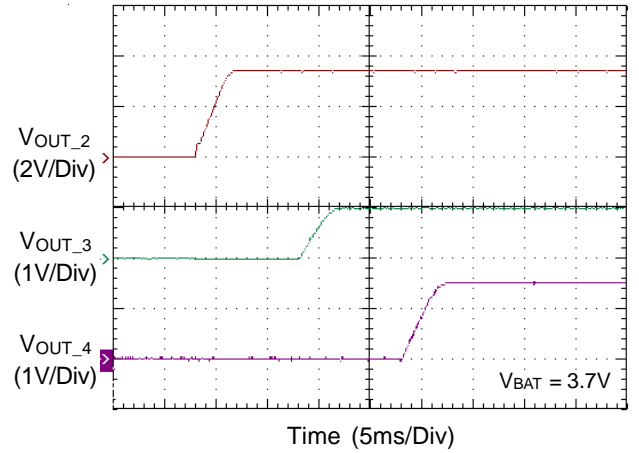

Power Off Sequence 0

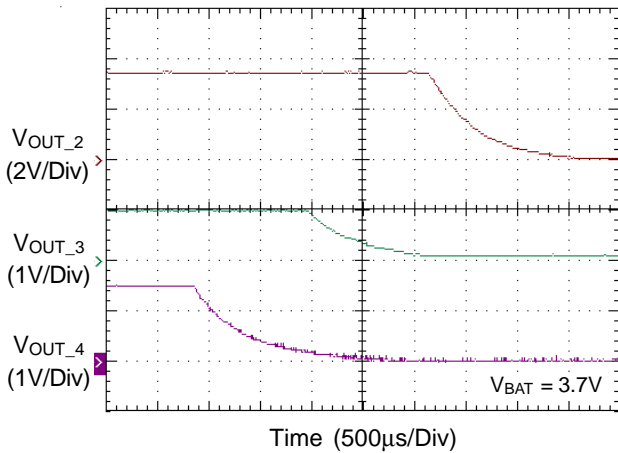

Power On Sequence 1

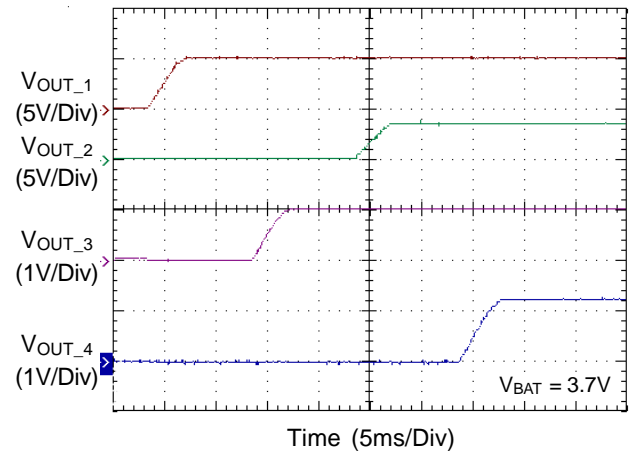

Power Off Sequence 1

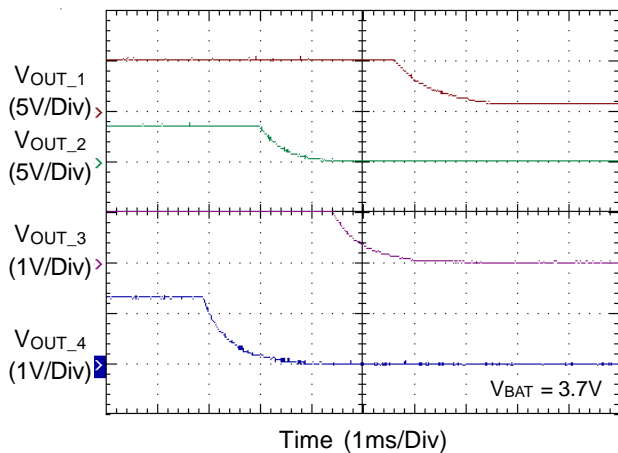

Power On Sequence 2

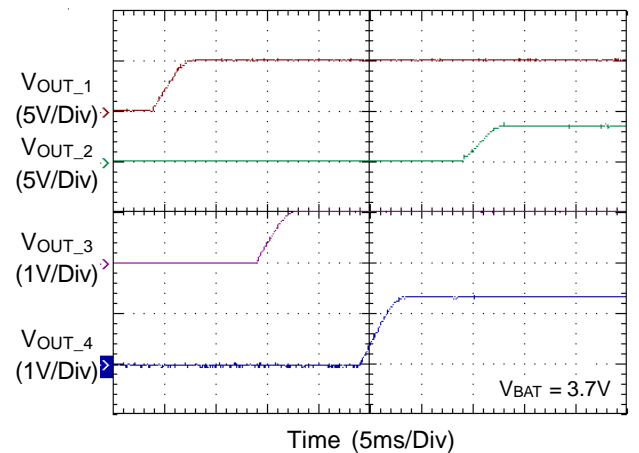



**Power Off Sequence 2**

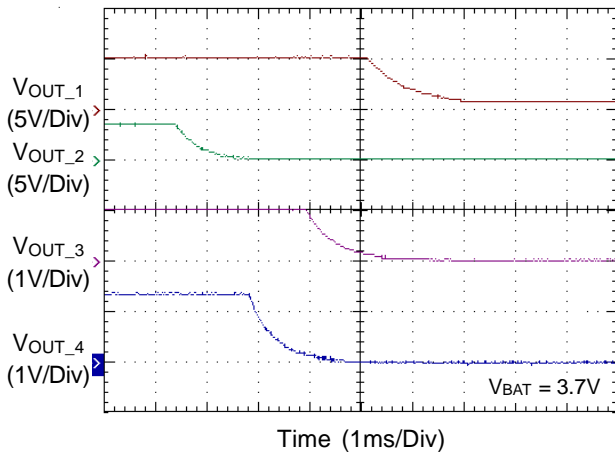

**Power On Sequence 3**

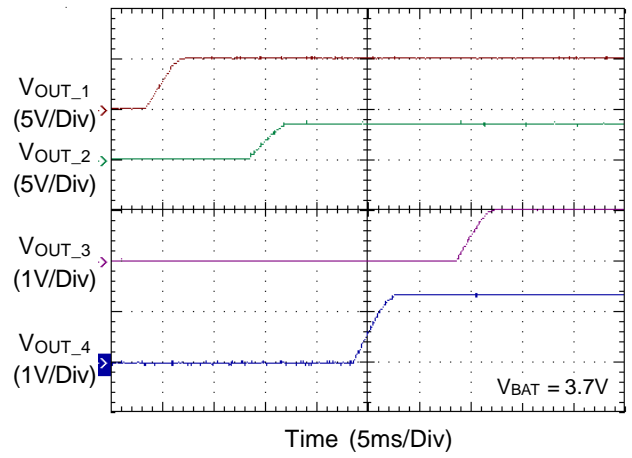

**Power Off Sequence 3**

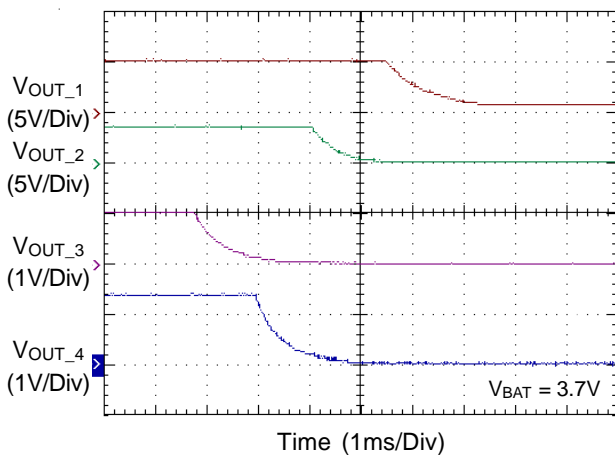

**Power On Sequence 4**

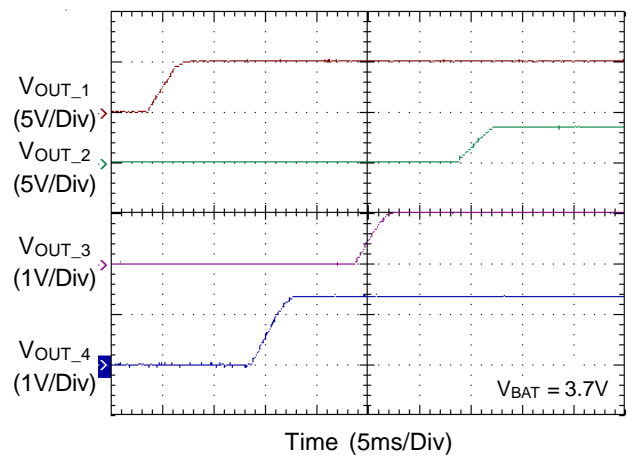

**Power Off Sequence 4**

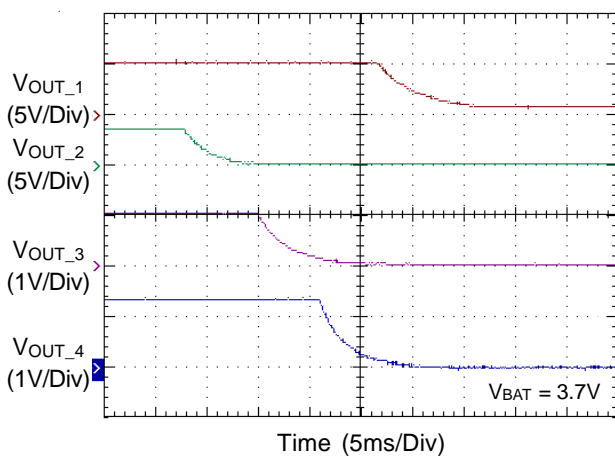

**Power On Sequence 5**

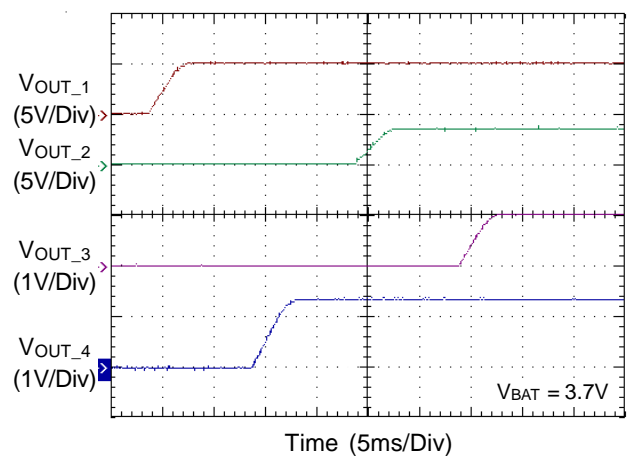

Power Off Sequence 5

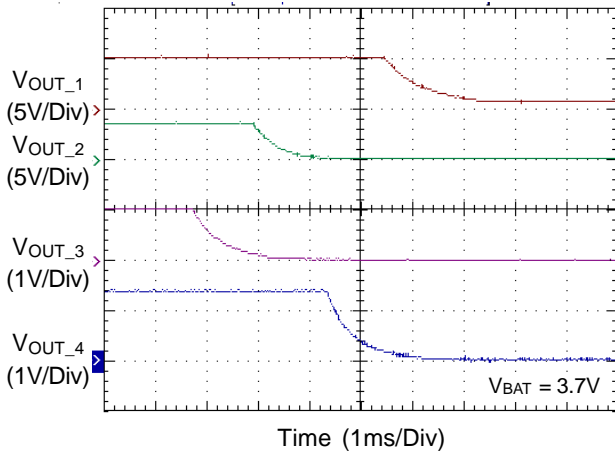

Charge On/Off Control by I<sup>2</sup>C

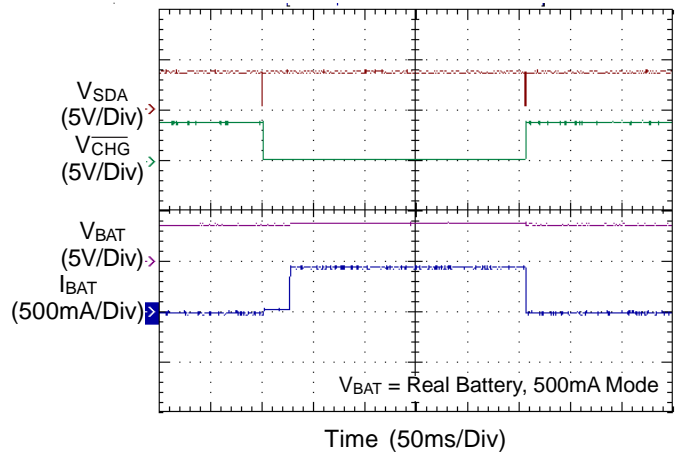

V<sub>TS</sub> On/Off

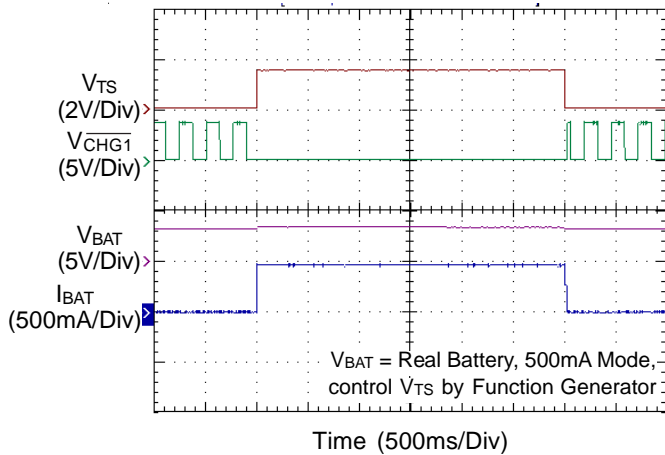

V<sub>IN</sub> Removal

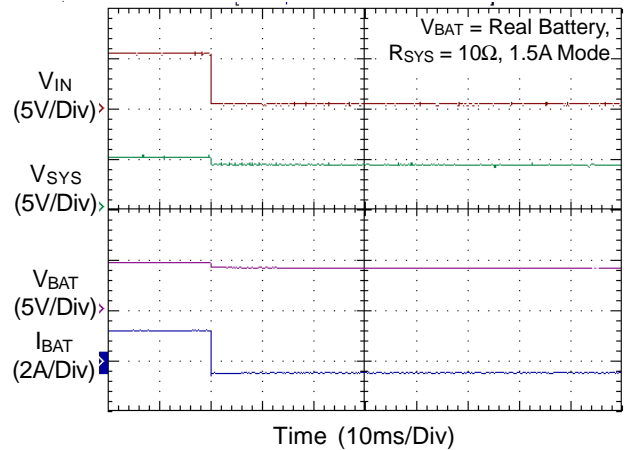

V<sub>IN</sub> Over Voltage Protection

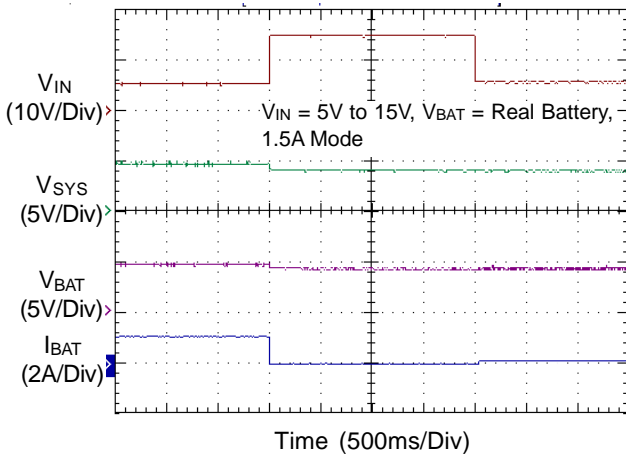

Battery with NTC Resistor Plug-In

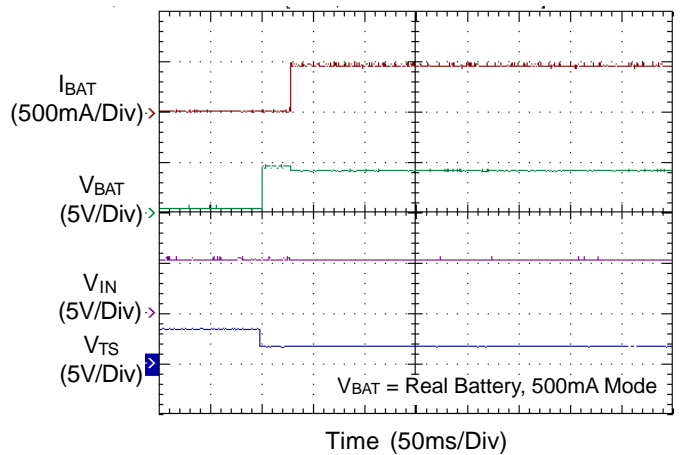

**Battery with NTC Resistor Plug-Out**

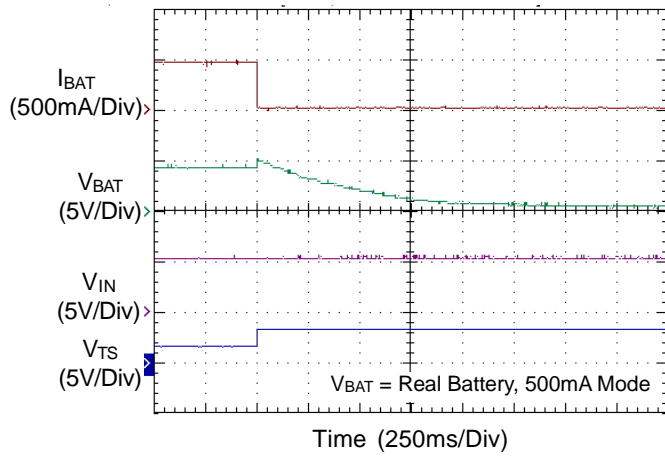

**With Battery without NTC Resistor**

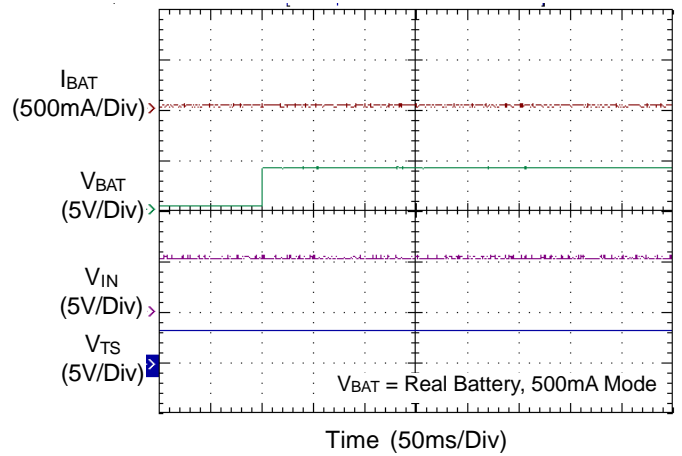

**With NTC Resistor without Battery**

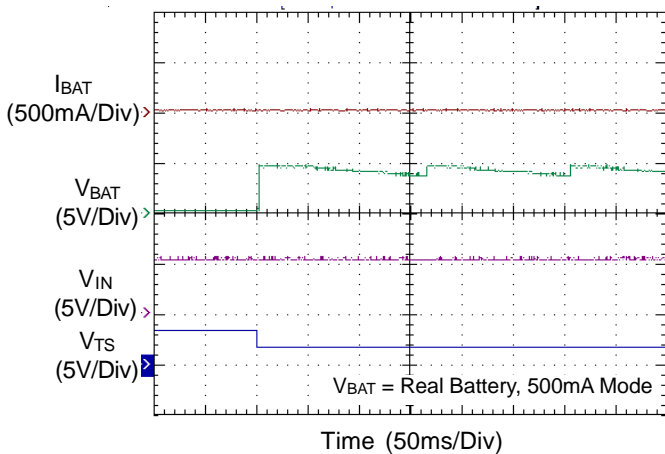

**$V_{IN}$  Exist then Negative Battery and Plug-out**

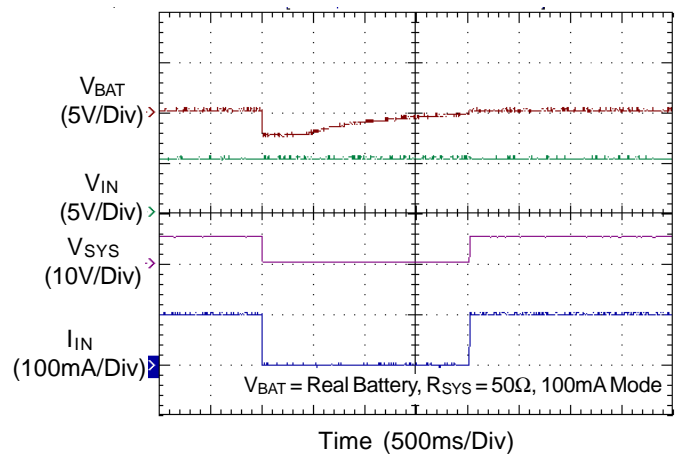

**Negative Battery then  $V_{IN}$  Plug-In**

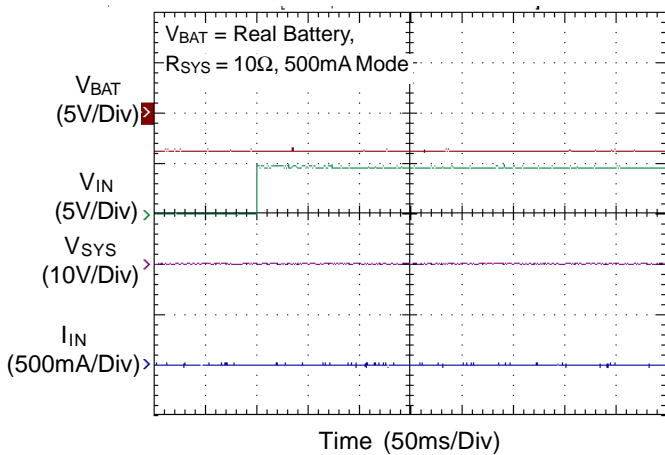

**The Temperature of Battery Status**

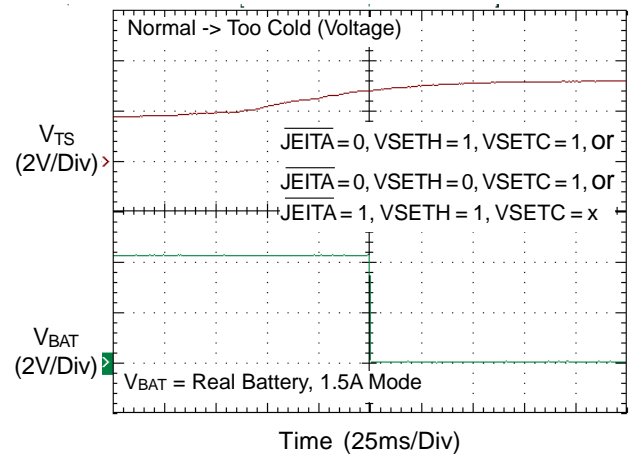

The Temperature of Battery Status

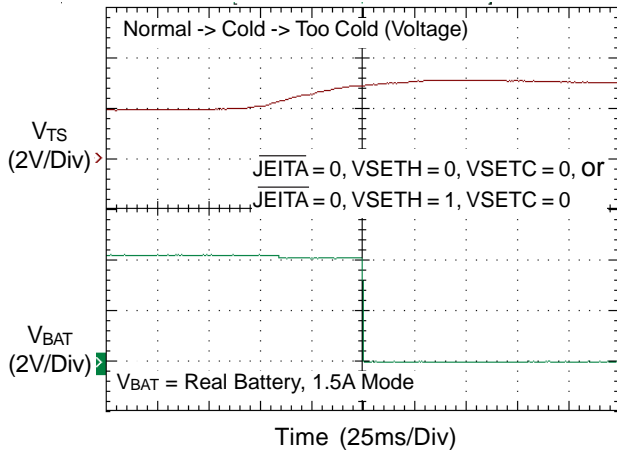

The Temperature of Battery Status

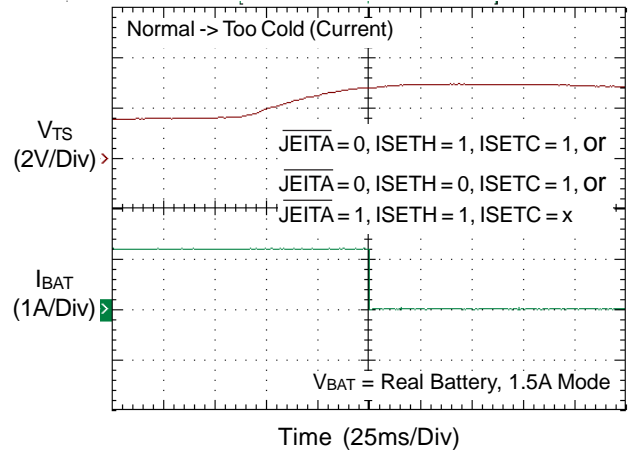

The Temperature of Battery Status

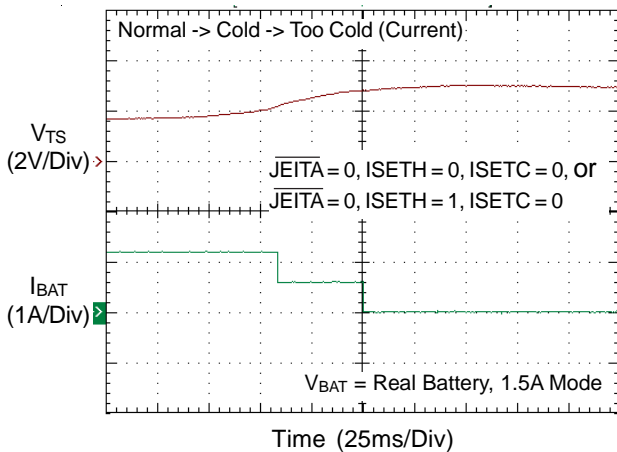

The Temperature of Battery Status

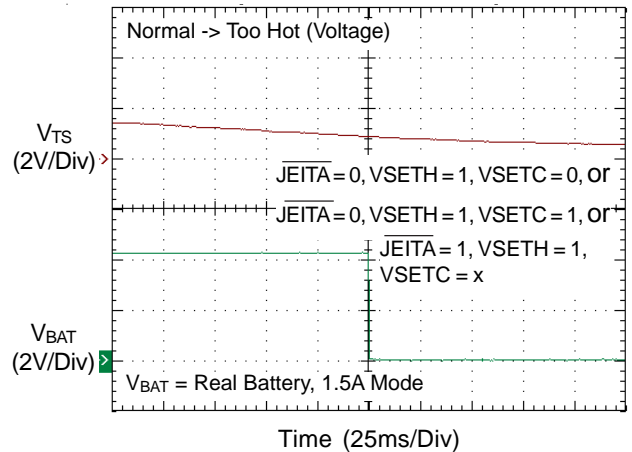

The Temperature of Battery Status

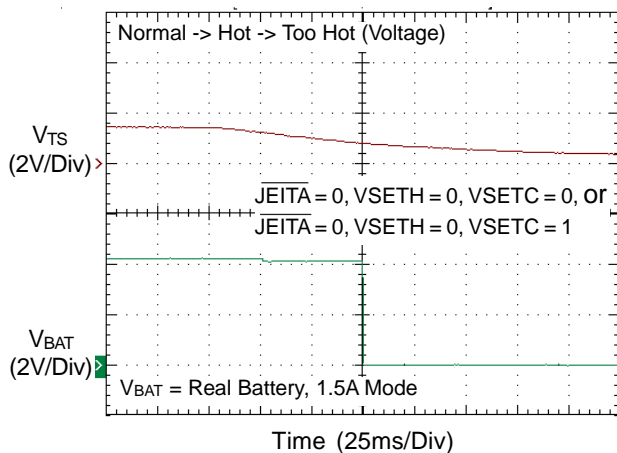

The Temperature of Battery Status

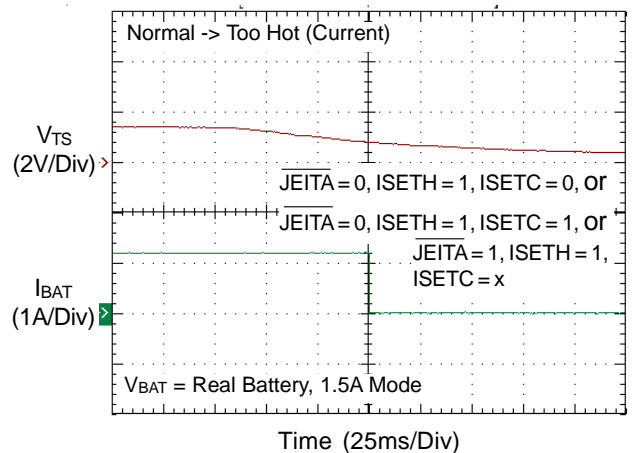

**The Temperature of Battery Status**

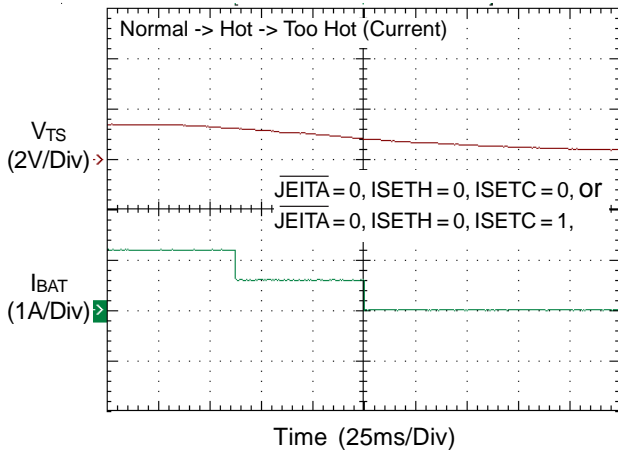

**APPM**

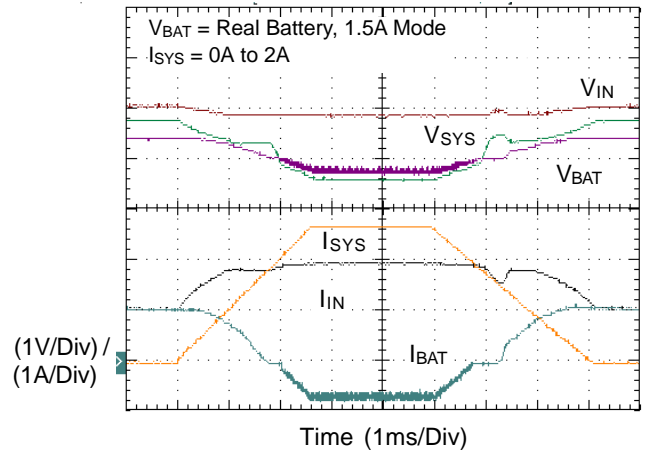

**System Regulation Voltage vs. Temperature**

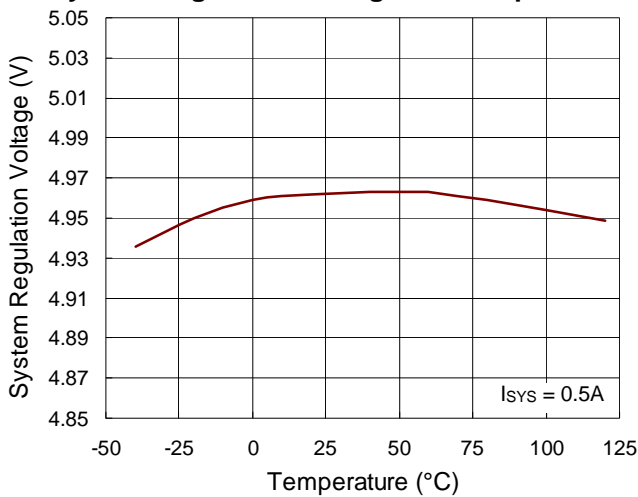

**OVP Threshold Voltage vs. Temperature**

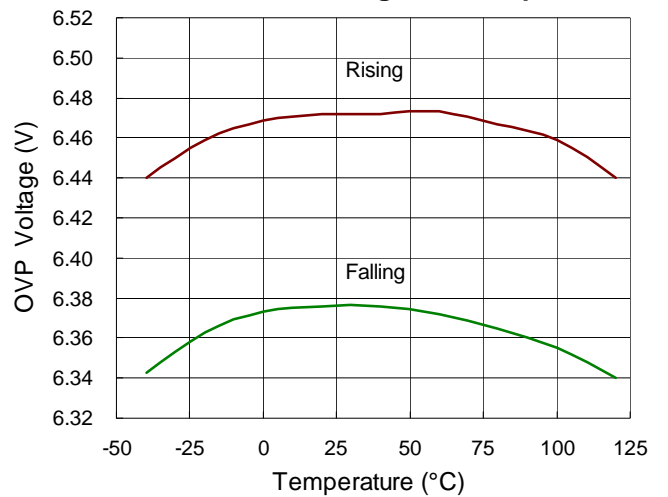

**$V_{IN} - V_{SYS}$  Dropout Voltage vs. Temperature**

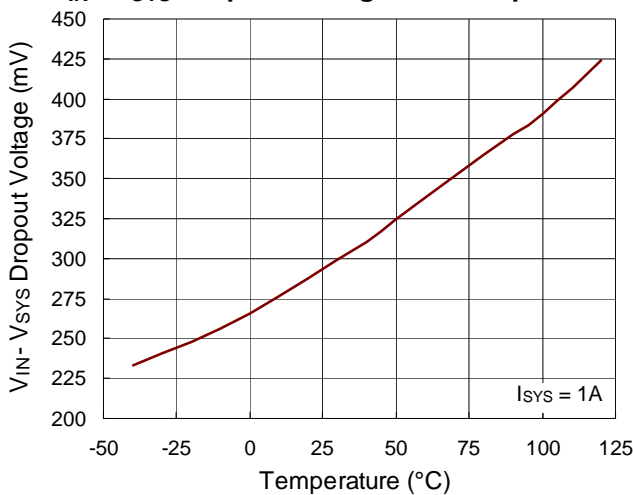

**$V_{BAT} - V_{SYS}$  Dropout Voltage vs. Temperature**

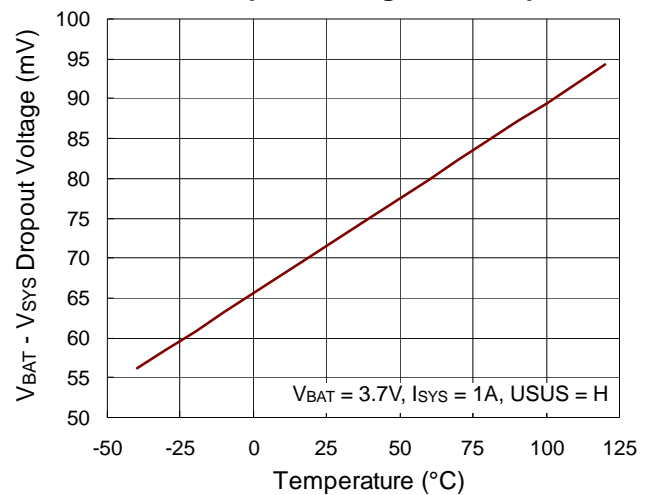

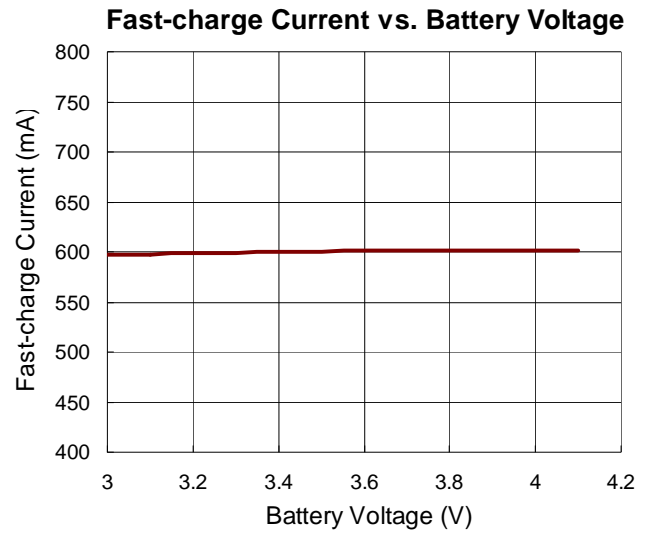
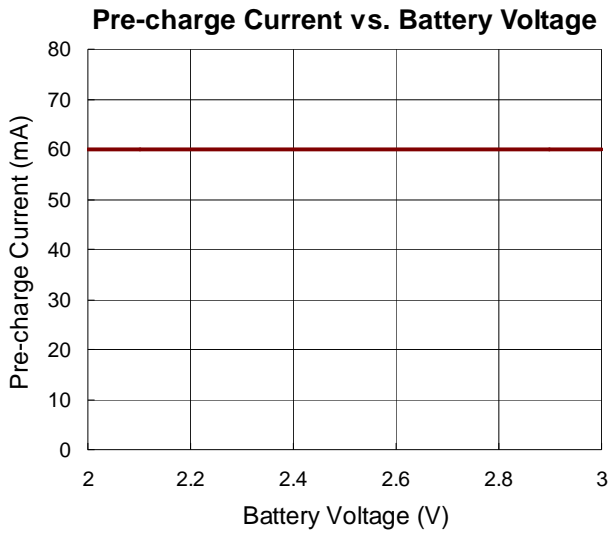
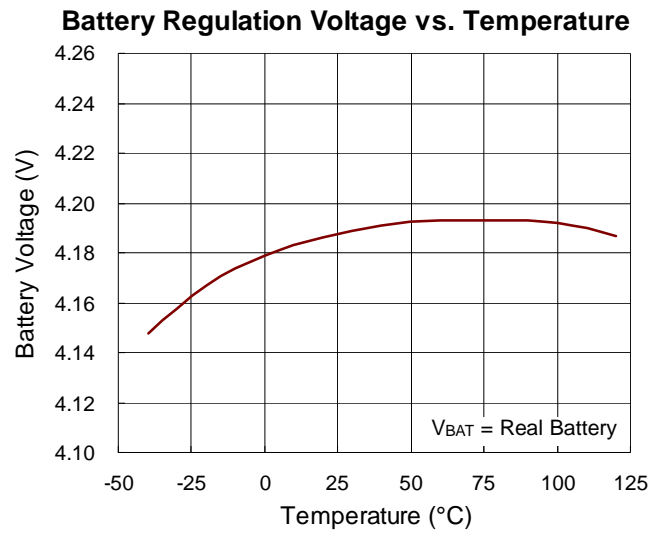
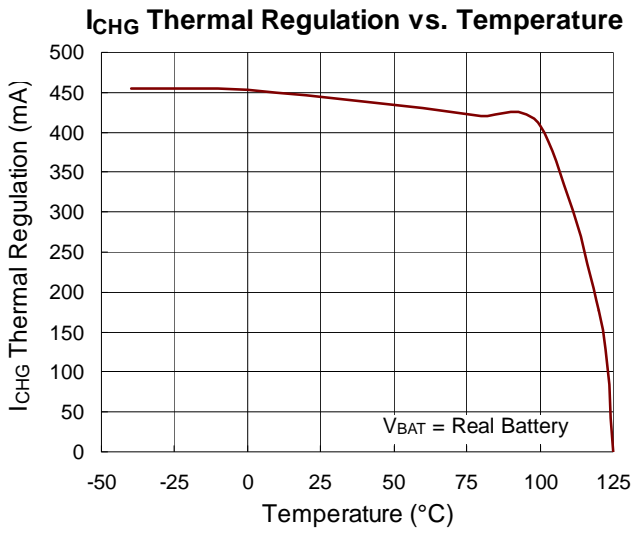

## Application Information

### Power Converter Unit

The RT5016C is an integrated power solution for digital still cameras and other small handheld devices. It includes six DC-DC converters, a WLED driver, two low output LDO, a RTC LDO, and a fully integrated single-cell Li-ion battery charger that is ideal for portable applications.

### CH1 : Synchronous Step-Up DC-DC Converter

The synchronous step-up DC-DC converter can be operated in either PFM or Sync-PWM mode by setting I<sup>2</sup>C. It includes internal power MOSFETs, compensation network and feedback resistors. The P-MOSFET can be controlled to disconnect output loading. It is suitable for providing power to the motor. The output voltage of CH1 can be adjusted by the I<sup>2</sup>C interface in the range of 3.6V to 5.5V.

VOUT1 [3:0]	CH1 regulation voltage can be selected by I <sup>2</sup> C interface. The default voltage is 5V.							
	Code	Voltage	Code	Voltage	Code	Voltage	Code	Voltage
	0000	3.6V	0001	3.7V	0010	3.8V	0011	3.9V
	0100	4V	0101	4.5V	0110	4.6V	0111	4.7V
	1000	4.8V	1001	4.9V	1010	5V	1011	5.1V
	1100	5.2V	1101	5.3V	1110	5.4V	1111	5.5V

### CH2 : Synchronous Step-Up/Down (Buck-Boost) DC-DC Converter

The synchronous step-up/down (Buck-Boost) DC-DC converter can be operated in either PFM or Sync-PWM mode by setting I<sup>2</sup>C. It includes internal power MOSFETs, compensation network and feedback resistors. This channel supplies the power for I/O. The FB voltage of CH2 can be adjusted by the I<sup>2</sup>C interface in the range of 0.72V to 0.86V.

FB2 [2:0]	FB2 regulation voltage can be selected by I <sup>2</sup> C interface. The default voltage is 0.8V.				
	Code	VREF	If Target = 1.8V	If Target = 1V	If Target = 3.3V
	000	0.72V	1.62V	0.9V	2.97V
	001	0.74V	1.665V	0.925V	3.0525V
	010	0.76V	1.71V	0.95V	3.135V
	011	0.78V	1.755V	0.975V	3.2175V
	100	0.8V	1.8V	1V	3.3V
	101	0.82V	1.845V	1.025V	3.3825V
	110	0.84V	1.89V	1.05V	3.465V
	111	0.86V	1.935V	1.075V	3.5475V

## CH3 to CH4 : Step-Down Synchronous DC/ DC Converter

The step-down synchronous DC/DC converters include internal power MOSFETs and compensation network. It support PFM or Sync-PWM mode by setting I<sup>2</sup>C. These channels supply the power for core and DRAM. They can be operated at 100% maximum duty cycle to extend battery operating voltage range. When the input voltage is close to the output voltage, the converter enters low dropout mode with low output ripple. The FB voltage of CH3 and CH4 can be adjusted by the I<sup>2</sup>C interface in the range of 0.72V to 0.86V.

FB3 [2:0]	FB3 regulation voltage can be selected by I <sup>2</sup> C interface. The default voltage is 0.8V.				
	Code	VREF	If Target = 1.8V	If Target = 1V	If Target = 3.3V
	000	0.72V	1.62V	0.9V	2.97V
	001	0.74V	1.665V	0.925V	3.0525V
	010	0.76V	1.71V	0.95V	3.135V
	011	0.78V	1.755V	0.975V	3.2175V
	100	0.8V	1.8V	1V	3.3V
	101	0.82V	1.845V	1.025V	3.3825V
	110	0.84V	1.89V	1.05V	3.465V
111	0.86V	1.935V	1.075V	3.5475V	

FB4 [2:0]	FB4 regulation voltage can be selected by I <sup>2</sup> C interface. The default voltage is 0.8V.				
	Code	VREF	If Target = 1.8V	If Target = 1V	If Target = 3.3V
	000	0.72V	1.62V	0.9V	2.97V
	001	0.74V	1.665V	0.925V	3.0525V
	010	0.76V	1.71V	0.95V	3.135V
	011	0.78V	1.755V	0.975V	3.2175V
	100	0.8V	1.8V	1V	3.3V
	101	0.82V	1.845V	1.025V	3.3825V
	110	0.84V	1.89V	1.05V	3.465V
111	0.86V	1.935V	1.075V	3.5475V	

If CH3/CH4 input voltage (PVD3/PVD45) is higher than 4.2V and the output voltage is lower than 1.5V, a feed forward capacitor can be added to improve the transient response.

The capacitance can be estimated by the following equation :

$$C_{ff} = \frac{15.5 \times 10^{-6}}{R1}$$

For example, when R1 is 470kΩ, the available feed-forward capacitor is 33pF.

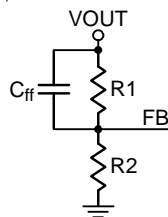



**CH5 : Step-Down Synchronous DC/DC Converter**

The step-down synchronous DC/DC converter includes internal power MOSFETs and compensation network. They can be operated at 100% maximum duty cycle to extend battery operating voltage range. When the input voltage is close to the output voltage, the converter enters low dropout mode with low output ripple. The output voltage can be selected as the following list or set by external feedback network.

VOUT5 [3:0]	CH5 regulation voltage can be selected by I <sup>2</sup> C interface. The default voltage is 1.8V.							
	<b>Code</b>	<b>Voltage</b>	<b>Code</b>	<b>Voltage</b>	<b>Code</b>	<b>Voltage</b>	<b>Code</b>	<b>Voltage</b>
	0000	REF	0001	1.1V	0010	1.2V	0011	1.3V
	0100	1.4V	0101	1.5V	0110	1.6V	0111	1.7V
	1000	1.8V	1001	2V	1010	2.2V	1011	2.3V
	1100	2.5V	1101	2.6V	1110	2.7V	1111	2.8V
Note : VOUT5 [3:0] = 0000 (REF) means using external feedback network and FB5 regulation target is 0.8V ± 1.5%								

**CH6 : Low Voltage LDO**

CH6 is a low voltage LDO and its output voltage is controlled by I<sup>2</sup>C interface. This supplies the multiple purpose power. The output voltage of CH6 can be adjusted by the I<sup>2</sup>C interface in the range of 1.1V to 3.3V.

VOUT6 [3:0]	CH6 regulation voltage can be selected by I <sup>2</sup> C interface. The default voltage is 1.3V.							
	<b>Code</b>	<b>Voltage</b>	<b>Code</b>	<b>Voltage</b>	<b>Code</b>	<b>Voltage</b>	<b>Code</b>	<b>Voltage</b>
	0000	Switch	0001	1.1V	0010	1.2V	0011	1.3V
	0100	1.4V	0101	1.5V	0110	1.6V	0111	1.7V
	1000	1.8V	1001	2V	1010	2.2V	1011	2.5V
	1100	2.8V	1101	3.1V	1110	3.2V	1111	3.3V

**CH7 : Current Source/Step-Up WLED Driver**

The WLED drivers operating in either current source mode or synchronous step-up mode include internal power MOSFET and compensation network. The operation mode is determined by setting I<sup>2</sup>C. The P-MOSFET in step-up mode can be controlled to disconnect the output loading.

When CH7 works in current source mode, it likes a LDO and regulates the current by FB7 voltage. The LED current is defined by the FB7 voltage as well as the external resistor between FB7 and GND. The FB7 regulation voltage can be set in 31 steps from 8mV to 250mV. If CH7 works in synchronous step-up mode, it can support an output voltage up to 15V or 21V controlled by I<sup>2</sup>C interface. The LED current is also set via an external resistor and FB7 regulation voltage.

The WLED current can be set by the following equation :

$$I_{LED} \text{ (mA)} = [250\text{mV} / R \text{ (}\Omega\text{)}] \times \text{EN7\_DIM7 [4:0]} / 31$$

where R is the current sense resistor from FB7 to GND and for the EN7\_DIM7 [4:0] / 31 ratio, refer to the I<sup>2</sup>C control register file.

## CH8 : Low Voltage LDO

CH8 is a low voltage LDO and its output voltage is controlled by I<sup>2</sup>C interface. It supplies for multiple purpose power. The output voltage of CH8 can be adjusted by the I<sup>2</sup>C interface in the range of 1.1V to 3.3V.

VOUT8 [3:0]	CH8 regulation voltage can be selected by I <sup>2</sup> C interface. The default voltage is 2.8V.							
	Code	Voltage	Code	Voltage	Code	Voltage	Code	Voltage
	0000	Switch	0001	1.1V	0010	1.2V	0011	1.3V
	0100	1.4V	0101	1.5V	0110	1.6V	0111	1.7V
	1000	1.8V	1001	2V	1010	2.2V	1011	2.5V
1100	2.8V	1101	3.1V	1110	3.2V	1111	3.3V	

## RTC\_LDO : Accuracy 3.05V LDO Output.

The RT5016C provides a 3.05V output LDO for real-time clock. The LDO features low quiescent current (3μA), reverse leakage prevention from output node and high output voltage accuracy. This LDO is always on, even when the system is shut down. For better stability, it is recommended to connect a 0.1μF capacitor to the RTCPWR pin. The RTC LDO includes pass transistor body diode control to avoid the RTCPWR node from back-charging into the input node VDDI.

## Switching Frequency

The converters of CH1, CH3, CH4 and CH5 operate in PWM mode with 2MHz switching frequency. The converters of CH2 and CH7 operates in PWM mode with 1MHz switching frequency.

## Power-On/Off Sequence and deglitch function for CH1 to CH4

SEQ pull down resistance R<sub>SEQ</sub> defines power on/off sequence.

SEQ#	R <sub>SEQ</sub> (kΩ) Range		
	Min	Typ	Max
SEQ #0	Short to Power (>0.2V)		
SEQ #1	25	40	64
SEQ #2	6.25	10	16
SEQ #3	1.56	2.5	4
SEQ #4	--	0.63	1
SEQ #5	100	160	--

**SEQ # 0 : CH2 CH3 CH4**

**(CH1 is decided by register A4 bit3.)**

**SEQ # 1 : CH1 → CH3 → CH2 → CH4**

**SEQ # 2 : CH1 → CH3 → CH4 → CH2**

**SEQ # 3 : CH1 → CH2 → CH4 → CH3**

**SEQ # 4 : CH1 → CH4 → CH3 → CH2**

**SEQ # 5 : CH1 → CH4 → CH2 → CH3**

**Floating = resistance greater than 160kΩ = SEQ#5**

The power-on sequence of CH1 to CH4 is shown below :

(Using SEQ #3 : CH1 → CH2 → CH4 → CH3 to explain)

When EN1234 goes high, CH1 will be turned on first then CH2 will be turned on after CH1 turn on for 10ms, likewise, CH4 will be turned on after CH2 turns on for 10ms. Finally, CH3 is turned on after CH4 turns on for 10ms. The soft-start time is 4ms for each channel.

The power-off sequence of CH1 to CH4 is :

When EN1234 goes low, CH3 will turn off first and internally discharge output via LX3 pin. When FB3 < 0.1V, CH4 will turn off and also internally discharge output via the LX4 pin. When FB4 < 0.1V, CH2 will turn off and internally discharge output via the LX2 pin. Likewise, when FB2 < 0.1V, CH1 will turn off and discharge output. After FB1 < 0.1V, CH1 to CH4 shutdown sequence is completed.

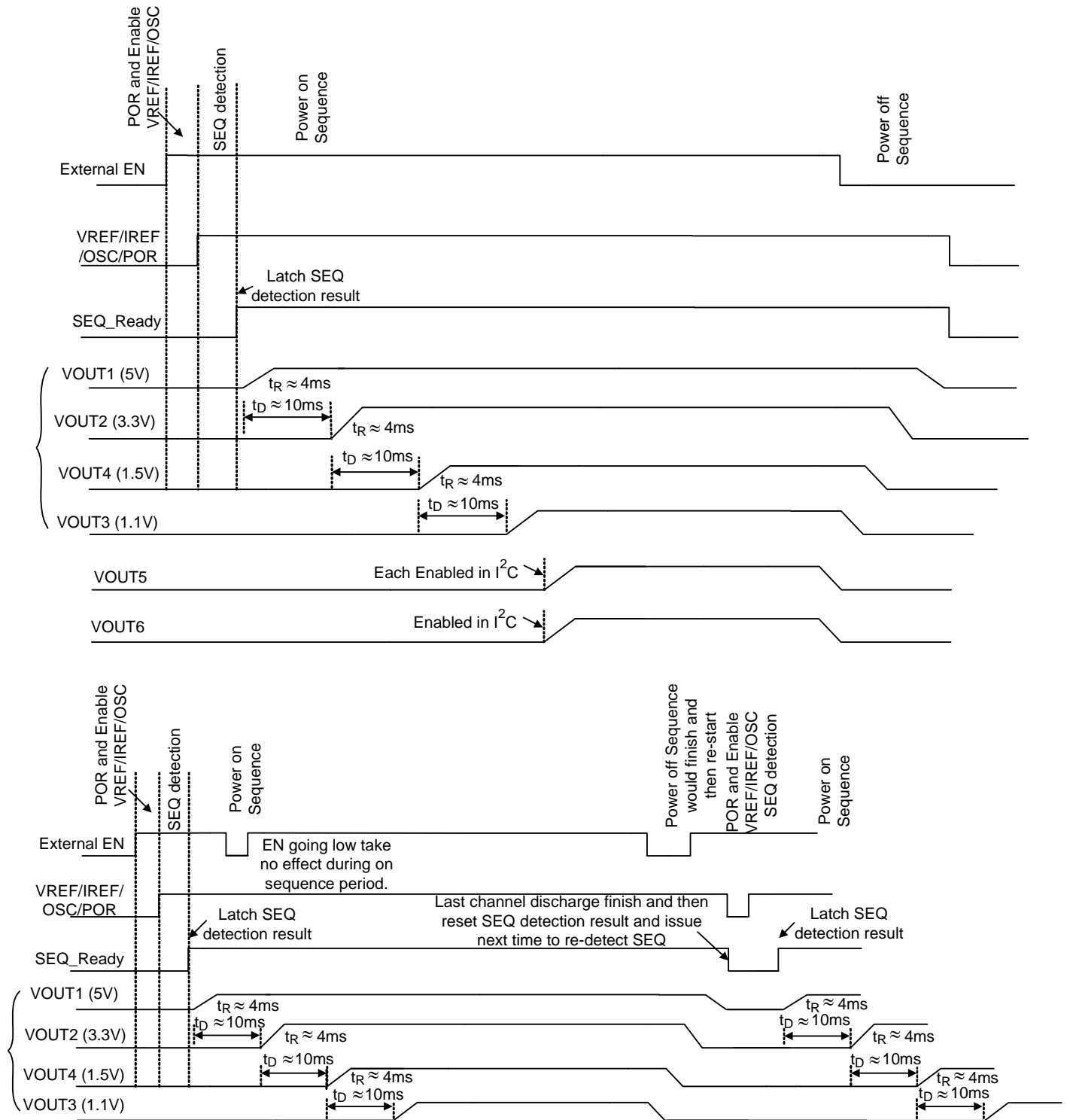

During On sequence period, EN goes low would not take effect. After the sequence finishes, the EN state would be re-checked and decide to keep on or start off sequence.

During Off sequence period, EN goes high would not take effect. After the sequence finishes, the EN state would be re-checked and decide to keep off or start on sequence.

## VDDM Bootstrap

To support bootstrap function, the RT5016C provides a power selection circuit which selects the maximum voltage between SYS and PVD1 to support the power requirement at node VDDI. The RT5016C includes UVLO circuits to monitor VDDI and SYS voltage status.

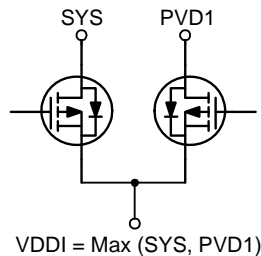

## Charger Unit

The RT5016C includes a Li-ion battery charger with Automatic Power Path Management. The charger is designed to operate in below modes :

### ► Pre-Charge Mode

When the output voltage is lower than 2.8V, the charging current will be reduced to a ratio of the fast-charge current set by A8.ISETA [3:0] to protect the battery life-time. The timing diagram is showed in Figure 3.

### ► Fast-Charge Mode

When the output voltage is higher than 3V, the charging current will be equal to the fast-charge current set by A8.ISETA [3:0] shown as Figure 3.

### ► Constant Voltage Mode

When the output voltage is near 4.2V and the charging current falls below the termination current for a deglitch time of 25ms, the charger will be disabled and CHG will go high. The timing diagram is showed in Figure 3.

### ► Re-Charge Mode

When the chip is in charge termination mode, the charging current gradually goes down to zero. Once the battery voltage drops to below 4.1V for a deglitch time of 100ms, the charger will resume charging shown as Figure 3.

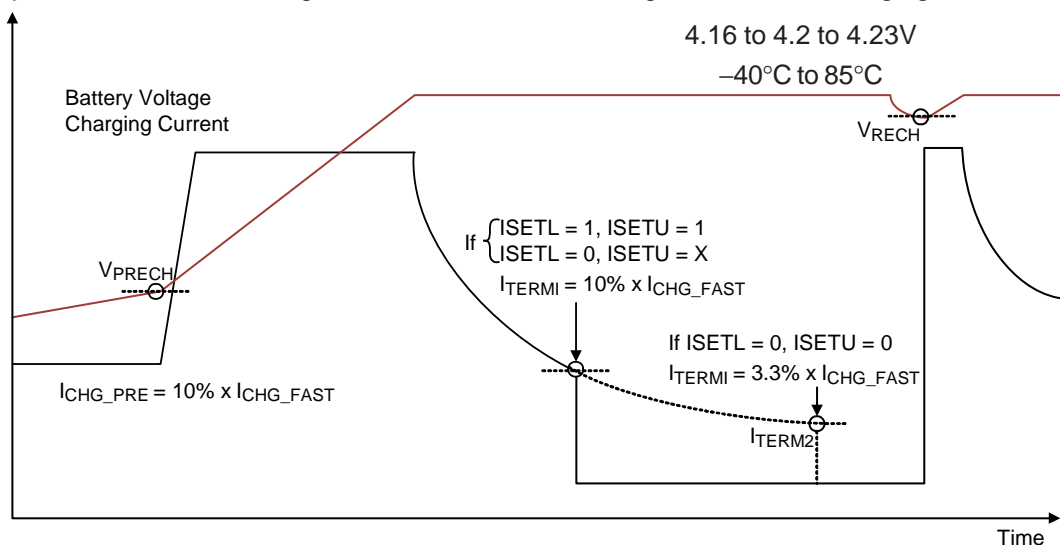

Figure 3

**Interrupt Indicator**

The RT5016C provides an interrupt indicator output pin ( $\overline{\text{INT}}$ ).  $\overline{\text{INT}}$  is an open-drain output which is controlled by A9.INT bit. When the PGOOD, TS\_Meter [2:0], EOC, THR,  $\overline{\text{SAFE}}$ , NoBAT, CHGRUN, DPM status bits toggle, the A9.INT bit will be set to high. In order to reset the interrupt status, a "0" must be written to the A9.INT bit or power on the PMU again. The timing diagram is shown below :

**Interrupt vs. Events (I<sup>2</sup>C Status Bits)**

$\overline{\text{INT}}$ assert (Turn to low)	When PMU turns on with event condition		During PMU on	
	No Event (0)	Event has occurred (1)	Event appear (0 → 1)	Event disappear (1 → 0)
PGOOD	No	Yes	Yes	Yes
NoBAT	No	Yes	Yes	Yes
TS_METER [2:0] = 000 (Event may be cold or hot, VP UVLO, NoBAT)	No	Yes	Yes	Yes
EOC	No	Yes	Yes	Yes
THR	No	Yes	Yes	Yes
$\overline{\text{SAFE}}$	No	Yes	Yes	Yes
DPM	No	Yes	Yes	Yes
CHGRUN	No	No	No	Yes

**$\overline{\text{INT}}$  vs. Fault/Status Timing Diagram**

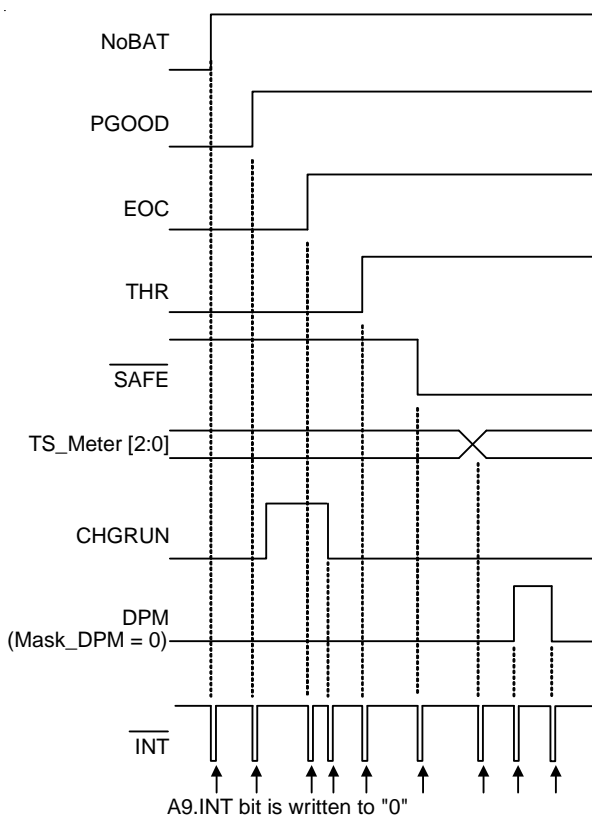

When the A9.INT bit is written to "0", the  $\overline{\text{INT}}$  will be set to high.  
 When Mask\_DPM = 1 and DPM event change, the  $\overline{\text{INT}}$  would not be asserted.

## Battery Installation Detection

The RT5016C also detects TS voltage to monitor the battery status. If PMU is enabled but TS voltage > 90% of VP node voltage, the RT5016C sets the bit.

NoBAT = 1 an I<sup>2</sup>C register A10.NoBAT and sets A9.INT bit to "1".

NoBAT	1	No Battery Installed (TS > 90% of VP)
	0	BAT Installed

## VIN Power Good Status

PGOOD	0	VIN < VUVLO
	0	VUVLO < VIN < VBAT + VOS_L
	1	VBAT + VOS_H < VIN < VOVP
	0	VIN > VOVP

## End\_Of\_Charge (EOC) Status

The bit EOC in I<sup>2</sup>C register A10.EOC can show the EOC status. If EOC = 1, the charger is in EOC state and A9.INT bit is set to "1"

EOC	1	Charging Done or Recharging after Termination
	0	During Charging

## Wake-Up Detector

Wake-Up Detector detects VIN or BAT plug-in events. Once BAT plugs in or VIN plugs in for a 19ms deglitch time, the WAKE pin will provide a 90ms width high pulse. The timing diagram is shown as below :

## SDP

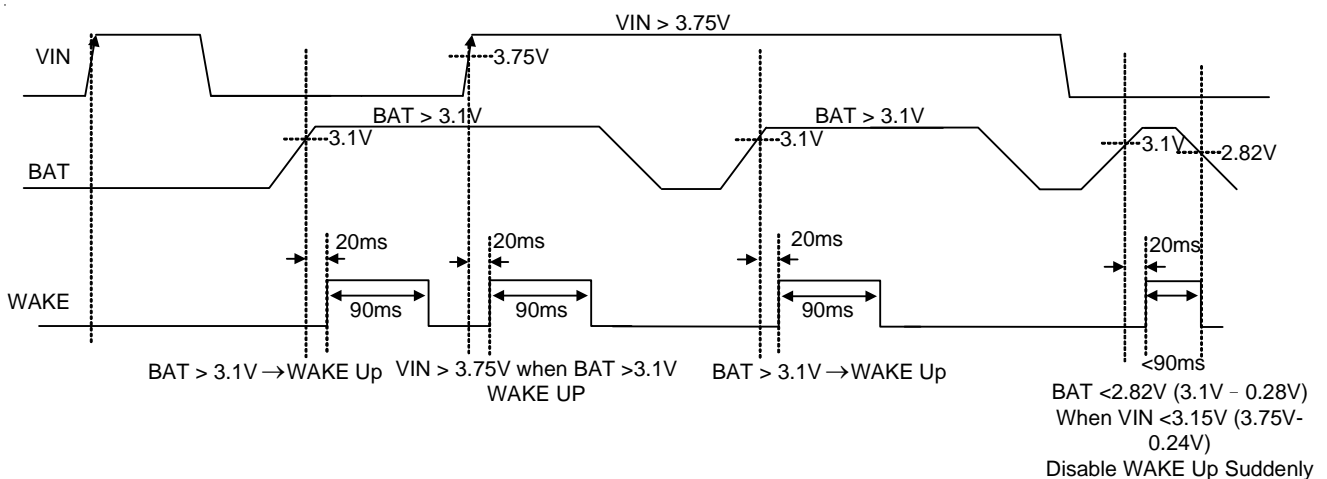

DCP

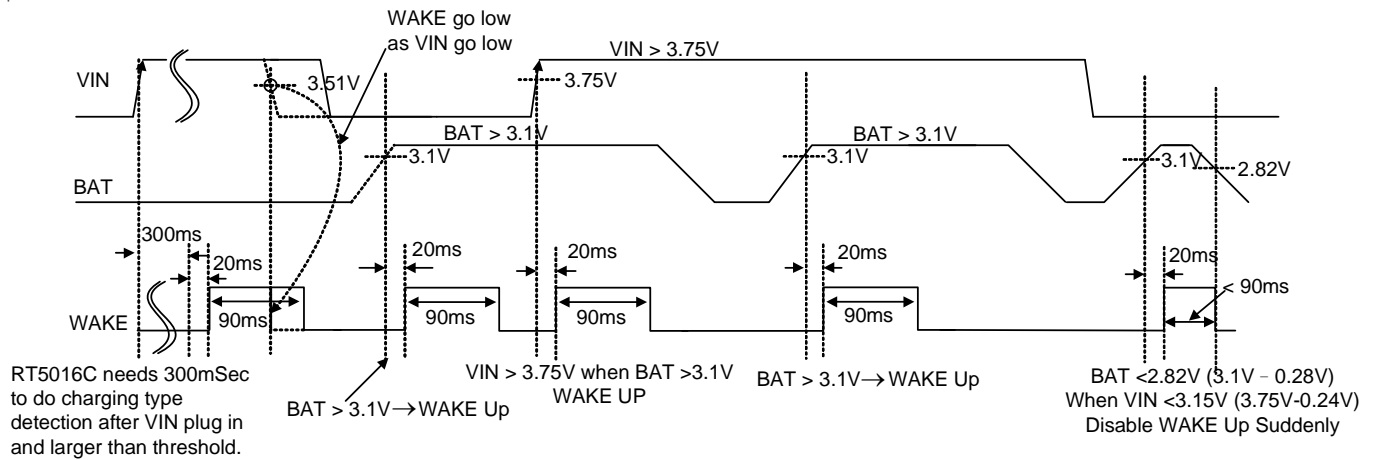

When external EN pin go high, WAKE UP impulse would be masked off. WAKE impulse width 90ms can not be cut by EN = H

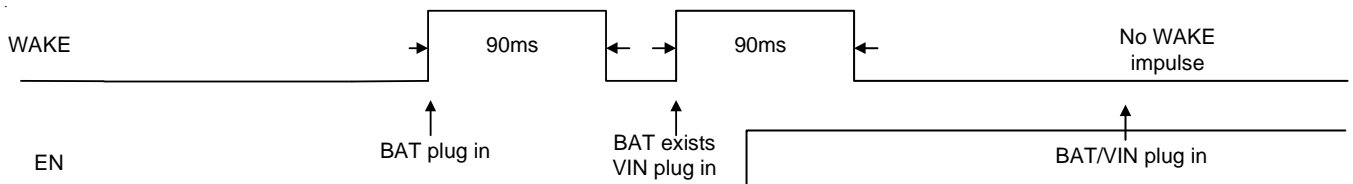

Suspend Mode

When USUS = 1, the charger will enter Suspend Mode. In Suspend Mode, the CHG pin is high impedance and IUSUS(MAX) < 300µA.

Charging Current Decision

The charge current can be set according to the I<sup>2</sup>C register A8.ISETA [3:0] setting :

ISETA [3:0]	RT5016C allows user to set the battery charge current level and the list as below. The default value is 0.5A.							
	Code	BAT Charge Current	Code	BAT Charge Current	Code	BAT Charge Current	Code	BAT Charge Current
	0000	0.1A	0001	0.2A	0010	0.3A	0011	0.4A
	0100	0.5A	0101	0.6A	0110	0.7A	0111	0.8A
	1000	0.9A	1001	1A	1010	1.1A	1011	1.2A
	1100	1.2A	1101	1.2A	1110	1.2A	1111	1.2A

## Fault-Time

During the fast charge phase, several events may increase the charging time.

For example, the system load current may have activated the APPM loop which reduces the available charging current or the device has entered thermal regulation because the IC junction temperature has exceeded  $T_{REG}$ .

However, once the duration exceeds the fault-time, the CHG output pin will flash at approximately 4Hz to indicate a fault condition and the charge current will be reduced to about 1mA.

There are four methods to release the Fault-time :

- ▶ Re-plug power
- ▶ Toggle EN
- ▶ Enter/exit suspend mode
- ▶ Remove Battery
- ▶ OVP

The fault-time is inverse proportional to the charger current.

$$\text{Fault-Time} \propto \frac{1}{I_{\text{charge}}}$$

Example :

If the sensing battery temperature is hot or cold, the charge current will reduce to half charge current. So, the fault-time will increase to be double.

## JEITA Battery Temperature Standard

CV regulation voltage will be changed in the following battery temperature ranges : 0°C to 10°C and 45°C to 60°C.

This function can be disabled by A9.VSETH and A9.VSETC.

CC regulation current will be changed in the following battery temperature ranges : 0°C to 10°C and 45°C to 60°C.

This function can be disabled by A9.ISETH and A9.ISETC.



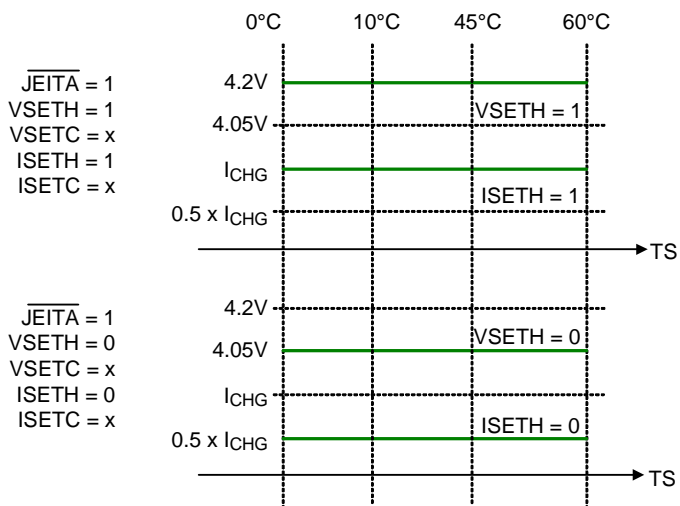
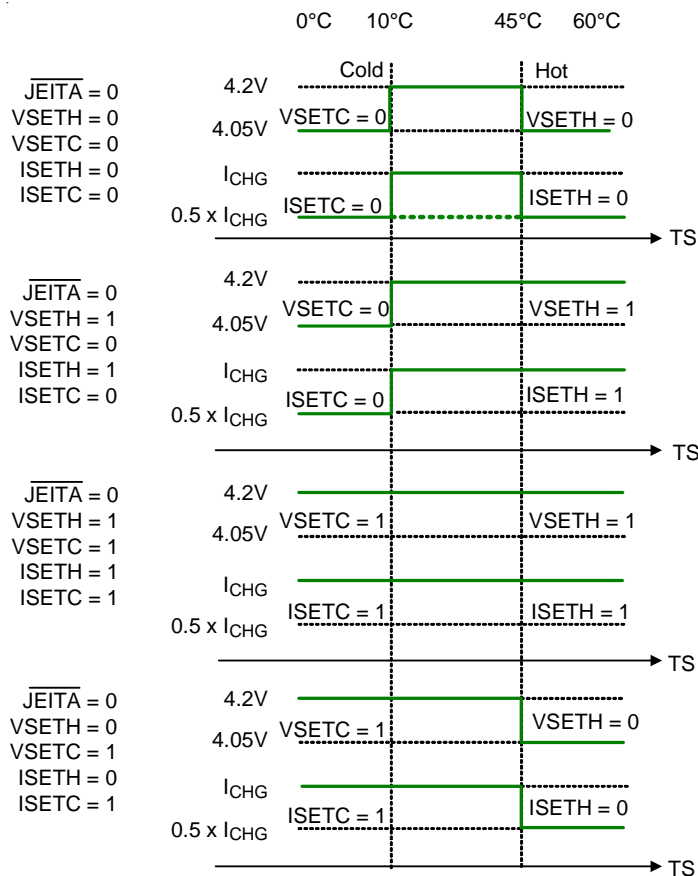

## Battery Pack Temperature Monitoring

The battery pack temperature monitoring function can be realized by connecting the TS pin to an external Negative Temperature Coefficient (NTC) thermal resistor to prevent over temperature condition. Charging is suspended when the voltage at the TS pin is out of normal operating range. The internal timer is then paused, but the value is maintained.

When the TS pin voltage returns to normal operating range, charging will resume and the safe charge timer will continue to count down from the point where it was suspended. Note that although charging is suspended due to the battery pack temperature fault, the  $\overline{\text{CHG}}$  pin will flash at 0.5Hz and indicate charging.

The 3.3V at the VP pin is buffered by the RT5016C once it is in charging state or its PMU part is enabled. If a 100kΩ NTC thermal resistor is used, the A0.TSSEL bit should be set to "1". If a 10kΩ NTC thermal resistor is used, the A0.TSSEL bit should be set to "0". The TSSEL bit determines the TS threshold levels for 0°C and 60°C. It also defines the TS threshold levels used in JEITA operation. The choosing method of R1 and R2 to meet battery temperature monitoring shows as below.

Case 1 : TSSEL = H (For 100kΩ NTC) :

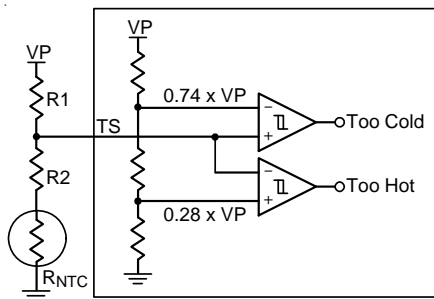

Figure 4

Case 2 : TSSEL = L (For 10kΩ NTC) :

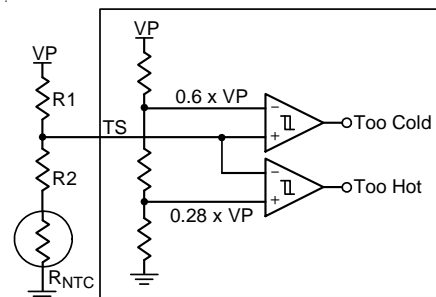

Figure 5

Too Cold Temperature

$$R_{\text{COLD}} = R_{\text{NTC}}$$

Too Hot Temperature

$$R_{\text{HOT}} = R_{\text{NTC}}$$

$$\frac{R_2 + R_{\text{COLD}}}{R_{\text{COLD}} + R_1 + R_2} = 0.74 \text{ ----- (1)}$$

$$\frac{R_2 + R_{\text{HOT}}}{R_{\text{HOT}} + R_1 + R_2} = 0.28 \text{ ----- (2)}$$

Form (1), (2)

$$R_1 = \frac{R_{\text{COLD}} - R_{\text{HOT}}}{2.457}$$

$$R_2 = 0.389 \times R_1 - R_{\text{HOT}}$$

If  $R_2 < 0$

$$\frac{R_{\text{COLD}}}{R_{\text{COLD}} + R_1} = 0.74 \text{ ----- (3)}$$

Form (3)

$$R_1 = \frac{R_{\text{COLD}}}{0.74} - R_{\text{COLD}}$$

Too Cold Temperature

$$R_{\text{COLD}} = R_{\text{NTC}}$$

Too Hot Temperature

$$R_{\text{HOT}} = R_{\text{NTC}}$$

$$\frac{R_2 + R_{\text{COLD}}}{R_{\text{COLD}} + R_1 + R_2} = 0.6 \text{ ----- (1)}$$

$$\frac{R_2 + R_{\text{HOT}}}{R_{\text{HOT}} + R_1 + R_2} = 0.28 \text{ ----- (2)}$$

Form (1), (2)

$$R_1 = 0.9 \times (R_{\text{COLD}} - R_{\text{HOT}})$$

$$R_2 = 0.388 \times R_1 - R_{\text{HOT}}$$

If  $R_2 < 0$

$$\frac{R_{\text{COLD}}}{R_{\text{COLD}} + R_1} = 0.6 \text{ ----- (3)}$$

Form (3)

$$R_1 = \frac{R_{\text{COLD}}}{0.6} - R_{\text{COLD}}$$

**The Control Temperature Used in JEITA Operation**

The above calculation gives R1 and R2. JEITA control thresholds for full charging current and 4.2V regulation voltage are at TS/VP ratio = 32% and 52% (for TSSEL = L), 35% and 64% (for TSSEL = H). With the ratio, the corresponding NTC thermistor resistances from the resistors in the voltage divider circuit can be obtained. According to the NTC resistances, the corresponding temperatures can be found. The two temperatures are the control temperatures used in JEITA operation.

**Operation State Diagram for TS Pin (TSSEL = H)**

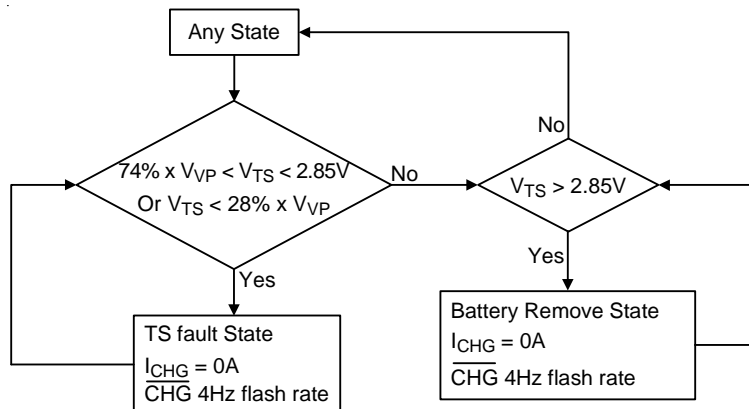

**Power Switch**

For the charger, there are three power scenarios :

- ▶ When a battery and an external power supply (USB or adapter) are connected simultaneously
 

If the system required load exceeds the input current limit, the battery will be used to supplement the current to the load. However, if the system load is less than the input current limit, the excess power from the external power supply will be used to charge the battery.
- ▶ When only the battery is connected to the system
 

The battery provides the power to the system.
- ▶ When only an external power supply is connected to the system
 

The external power supply provides the power to the system.

**Input DPM Mode**

For the charger, the input voltage is monitored when USB100 or USB500 is selected. If the input voltage is lower than VDPM, the input current limit will be reduced to stop the input voltage from dropping further. This can prevent the IC from damaging improperly configured or inadequately designed USB sources.

If VIN charger type is detected as SDP, the DPM function always is enabled.

For other types, the DPM function always is disabled but user can set A0.ENDPM to turn on the DPM function.

ENDPM	Enable the charger VIN DPM function. But if VIN charger type is detected as SDP (CHG_TYP [2:0] = 000), the DPM function always is enabled.
	0 : VIN DPM function disabled.
	1 : VIN DPM function enabled.

## APPM Mode

Once the sum of the charging current and system load current is higher than the maximum input current limit, the SYS pin voltage will be reduced. When the SYS pin voltage is reduced to V<sub>APPM</sub>, the RT5016C will automatically operate in APPM mode. In this mode, the charging current is reduced while the SYS current is increased to maintain system output. In APPM mode, the battery termination function is disabled.

## APPM Profile

1.5A Mode :

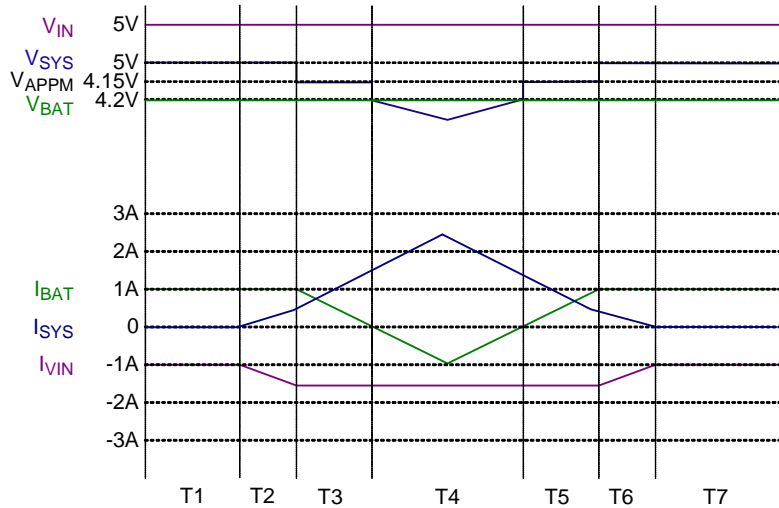

	I <sub>sys</sub>	V <sub>sys</sub>	I <sub>vin</sub>	I <sub>bat</sub>
T1, T7	0	SYS Regulation Voltage	CHG_MAX	CHG_MAX
T2, T6	< I <sub>vin_oc</sub> - CHG_MAX	SYS Regulation Voltage	I <sub>sys</sub> + CHG_MAX	CHG_MAX
T3, T5	> I <sub>vin_oc</sub> - CHG_MAX < I <sub>vin_oc</sub>	Auto Charge Voltage Threshold	V <sub>in_oc</sub>	V <sub>in_oc</sub> - I <sub>sys</sub>
T4	> I <sub>vin_oc</sub>	V <sub>bat</sub> - I <sub>bat</sub> × R <sub>DS(ON)</sub>	V <sub>in_oc</sub>	I <sub>sys</sub> - I <sub>vin_oc</sub>

500mA Mode :

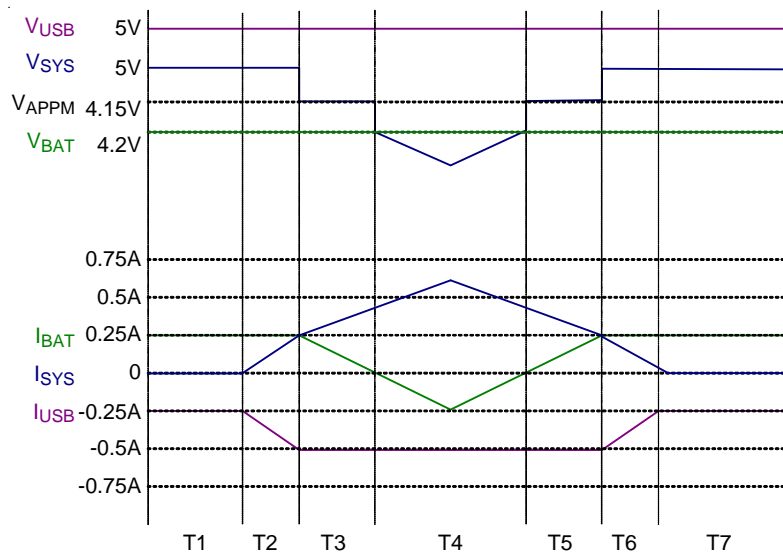

	<b>I<sub>sys</sub></b>	<b>V<sub>sys</sub></b>	<b>I<sub>usb</sub></b>	<b>I<sub>BAT</sub></b>
T1, T7	0	SYS Regulation Voltage	CHG_MAX	CHG_MAX
T2, T6	< I <sub>VIN_OC</sub> (USB) – CHG_MAX	SYS Regulation Voltage	I <sub>sys</sub> + CHG_MAX	CHG_MAX
T3, T5	> I <sub>VIN_OC</sub> (USB) – CHG_MAX < I <sub>VIN_OC</sub> (USB)	Auto Charge Voltage Threshold	I <sub>VIN_OC</sub> (USB)	I <sub>VIN_OC</sub> (USB) – I <sub>sys</sub>
T4	> I <sub>VIN_OC</sub> (USB)	V <sub>BAT</sub> – I <sub>BAT</sub> × R <sub>DS(ON)</sub>	I <sub>VIN_OC</sub> (USB)	I <sub>sys</sub> – I <sub>VIN_OC</sub> (USB)

**Battery Supplement Mode Short Circuit Protect**

In APPM mode, the SYS voltage will continue to drop if the charge current is zero and the system load increases beyond the input current limit. When the SYS voltage decreases below the battery voltage, the battery will kick in to supplement the system load until the SYS voltage rises above the battery voltage.

While in supplement mode, there is no battery supplement current regulation. However, a built-in short-circuit protection feature is available to prevent any abnormal current situation. While the battery is supplementing the load, if the difference between the battery and SYS voltage exceeds the short-circuit threshold voltage, SYS will be disabled. After a short-circuit recovery time, t<sub>SHORT\_R</sub>, the counter will be restarted. In supplement mode, the battery termination function is disabled. Note that the battery supply mode exiting condition is V<sub>BAT</sub> – V<sub>SYS</sub> < 0V.

**Thermal Regulation and Thermal Shutdown**

The charger provides a thermal regulation loop function to monitor the device temperature. If the die temperature rises above the regulation temperature, T<sub>REG</sub>, the charge current will automatically be reduced to lower the die temperature. However, in certain circumstances (such as high VIN, heavy system load, etc) even with the thermal loop in place, the die temperature may still continue to increase. In this case, if the temperature rises above the thermal shutdown threshold, T<sub>SD</sub>, the internal switch between VIN and SYS will be turned off. The switch between the battery and SYS will remain on however, to allow continuous battery power to the load. Once the die temperature decreases by ΔT<sub>SD</sub>, the internal switch between VIN and SYS will be turned on again and the device returns to normal thermal regulation. The internal thermal feedback circuitry regulates the die temperature to optimize the charge rate for all ambient temperatures.

## I<sup>2</sup>C Interface

RT5016C I<sup>2</sup>C slave address = 0010010 (7 bits). I<sup>2</sup>C interface supports fast mode (bit rate up to 400kb/s). The write or read bit stream ( $N \geq 1$ ) is shown below :

Read N bytes from RT5016C

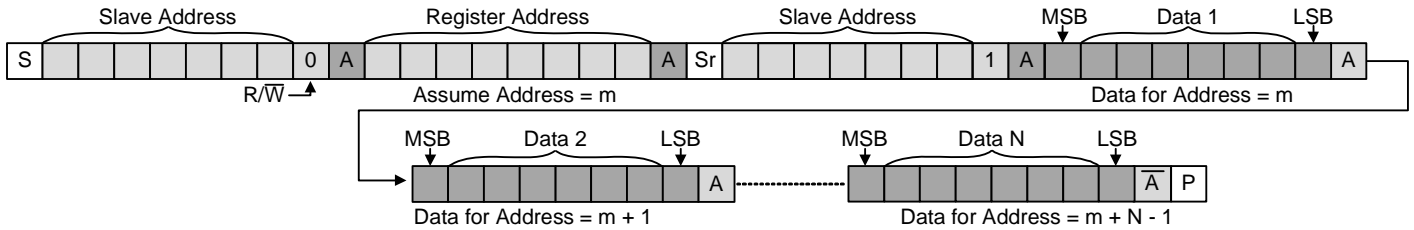

Write N bytes to RT5016C

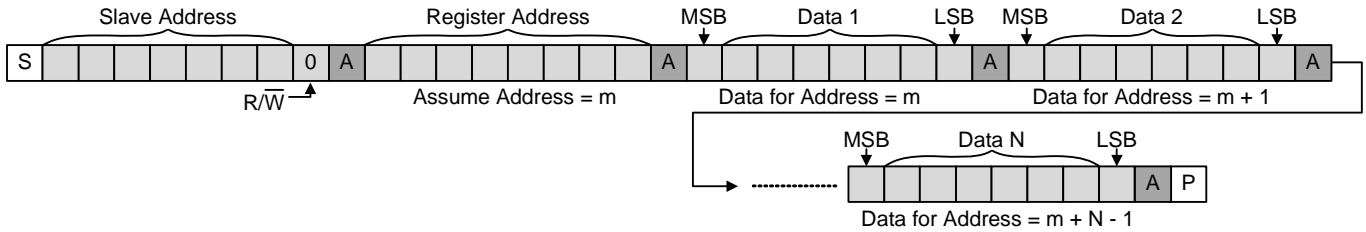

Driven by Master, 
  Driven by Slave (RT5016C), 
  Stop, 
  Start, 
  Sr Repeat Start

## I<sup>2</sup>C Waveform Information

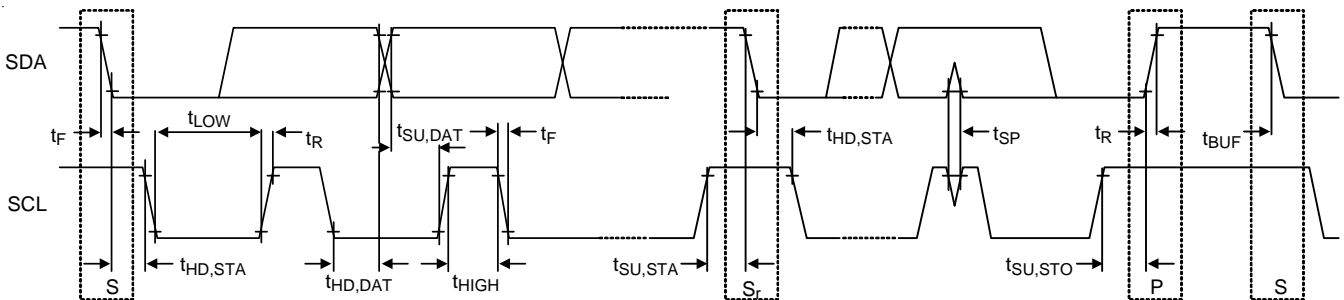

When the RT5016C and other I<sup>2</sup>C devices with 10-bit slave addressing (type I) or two-byte register addressing (type II) coexist in one I<sup>2</sup>C bus, the RT5016C needs one dummy I<sup>2</sup>C write frame to reset the RT5016C internal I<sup>2</sup>C operation state. The below shows a dummy write frame example, that is to write the RT5016C register A10 [7:0] = 00000000. Master should ignore the write operation (This operation is invalid). After the dummy frame, the master can read/write formal I<sup>2</sup>C frame for the RT5016C to get right operation.

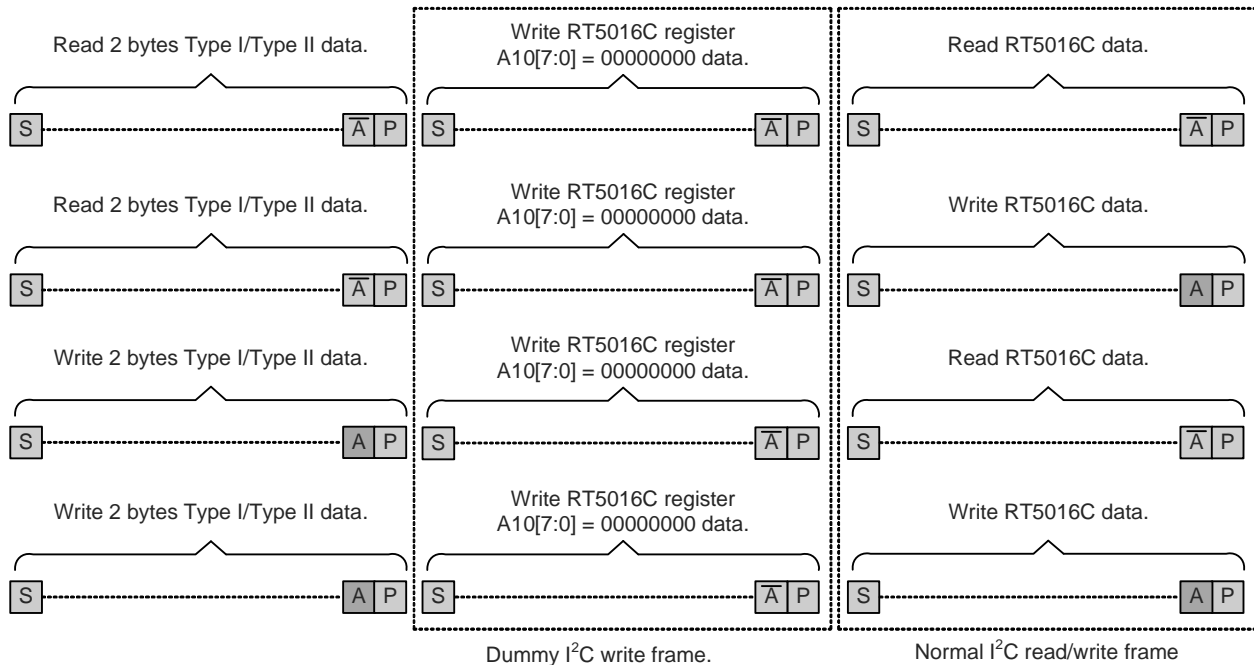

**Type I : 10-bit slave address data format**

In 10-bit addressing, the slave address is sent in the first two bytes. The first byte begins with the special reserved address of 11110X which indicates that 10-bit addressing is being used.

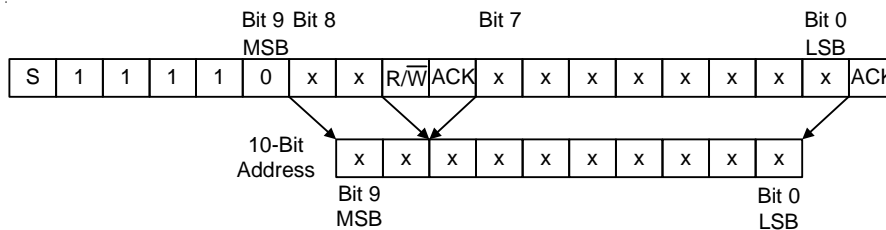

**Type II : 2-byte register address data format**

The register address is combined with 2-byte as below.

**2-Byte Register Address**

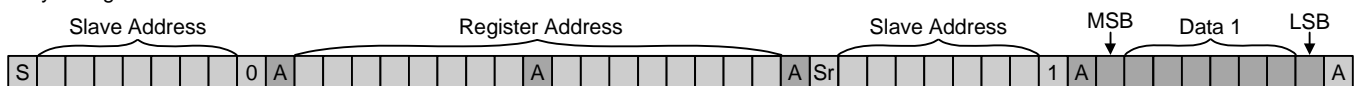

## I<sup>2</sup>C Register File

Address Name	Register Address	Bit7 (MSB)	Bit6	Bit5	Bit4	Bit3	Bit2	Bit1	Bit0 (LSB)	
A0	0x00	Meaning	RST_P	RST_C	OVP7	Reserved	ENDPM	TSD	MOD7	TSSEL
		Default	1	0	0	X	0	0	0	1
		Read/Write	R/W	R/W	R/W	--	R/W	R/W	R	R/W
RST_P		RT5016C would reset PMU-related registers under any one of the below two conditions : 1) VDDI < 1.3V 2) (EN pin = low and A0.RST_P = 1) In the 2 <sup>nd</sup> condition, RT5016C uses the register bit A0.RST_P to decide whether the PMU-related registers are reset or not when EN pin goes low. 0 : Don't reset register (0x3 to 0x6) 1 : Reset register (0x3 to 0x6).								
RST_C		RT5016C would reset Charge-related register under any one of the below three conditions : 1) VIN < 4V 2) VDDI < 1.3V 3) (BAT < 3.1V) and (A0.RST_C = 1) In the 3 <sup>rd</sup> condition, RT5016C uses the register bit A0.RST_C to decide whether the Charge-related registers are reset or not when BAT < 3.1V. 0 : Don't reset register (0x7 to 0x9). 1 : Reset register (0x7 to 0x9)								
OVP7		CH7 allow user to select the OVP level by I <sup>2</sup> C interface 0 : 16V OVP 1 : 25V OVP								
ENDPM		Enable the charger VIN DPM function. But if VIN charger type is detected as SDP (CHG_TYP [2:0] = 000), the DPM function always is enabled. 0 : VIN DPM function disabled 1 : VIN DPM function enabled.								
TSD		Report whether thermal shutdown of PMU ever occurs. Reset it by writing 0 into the bit or (VDDI < 1.3V). 0 : Thermal Shutdown has not occurred. 1 : Thermal Shutdown event ever occurs.								
MOD7		Report the result of CH7 mode detection. 0 : Current Source. 1 : Boost.								
TSSEL		TS/VP ratio setting for battery temperature. 0 : TS/VP = 60% (0°C), 28% (60°C) 1 : TS/VP = 74% (0°C), 28% (60°C)								



Address Name	Register Address	Bit7 (MSB)	Bit6	Bit5	Bit4	Bit3	Bit2	Bit1	Bit0 (LSB)	
A1	0x01	Meaning	ERR1	ERR2	ERR3	ERR4	ERR5	ERR6	ERR7	ERR8
		Default	0	0	0	0	0	0	0	0
		Read/Write	R/W	R/W	R/W	R/W	R/W	R/W	R/W	R/W
ERR1 to ERR8		Report whether the protection event of CH1 to CH8 ever occurs respectively. Reset it by writing 0 into the bit or (VRTC < 1.6V).								
		0 : No protection event occurs.								
		1 : Protection event ever occurs.								

Address Name	Register Address	Bit7 (MSB)	Bit6	Bit5	Bit4	Bit3	Bit2	Bit1	Bit0 (LSB)	
A2	0x02	Meaning	EN5	EN6	EN8	EN7_DIM7 [4:0]				
		Default	0	0	0	0	0	0	0	0
		Read/Write	R/W	R/W	R/W	R/W	R/W	R/W	R/W	R/W
EN5		Enable/disable CH5								
		0 : Disable								
		1 : Enable								
EN6		Enable/disable CH6								
		0 : Disable								
		1 : Enable								
EN8		Enable/disable CH8								
		0 : Disable								
		1 : Enable								
EN7_DIM7 [4:0]		Enable CH7 and define FB7 regulation voltage								
		00000 : CH7 turn off								
		00001 to 11111 : CH7 turn on and dimming ratio : VFB7 = EN7_DIM7 [4 : 0] / 31 x 0.25V								

Address Name	Register Address		Bit7 (MSB)	Bit6	Bit5	Bit4	Bit3	Bit2	Bit1	Bit0 (LSB)
A3	0x03	Meaning	PSM1	PSM2	PSM3	PSM4	VOUT8 [3:0]			
		Default	1	1	1	1	1	0	0	
		Read/Write	R/W	R/W	R/W	R/W	R/W	R/W	R/W	R/W
PSM1 to PSM4			Define the CH1/2/3/4 CCM or PWM/PSM switching operation. 0 : Force PWM 1 : Automatic PWM/PSM switch operation							
VOUT8 [3:0]			CH8 regulation voltage can be selected by I <sup>2</sup> C interface. The default voltage is 2.8V.							
			<b>Code</b>	<b>Voltage</b>	<b>Code</b>	<b>Voltage</b>	<b>Code</b>	<b>Voltage</b>	<b>Code</b>	<b>Voltage</b>
			0000	Switch	0001	1.1V	0010	1.2V	0011	1.3V
			0100	1.4V	0101	1.5V	0110	1.6V	0111	1.7V
			1000	1.8V	1001	2V	1010	2.2V	1011	2.5V
			1100	2.8V	1101	3.1V	1110	3.2V	1111	3.3V

Address Name	Register Address		Bit7 (MSB)	Bit6	Bit5	Bit4	Bit3	Bit2	Bit1	Bit0 (LSB)
A4	0x04	Meaning	VOUT1 [3:0]				EN1	FB2 [2:0]		
		Default	1	0	1	0	0	1	0	0
		Read/Write	R/W	R/W	R/W	R/W	R/W	R/W	R/W	R/W
VOUT1 [3:0]			CH1 regulation voltage can be selected by I <sup>2</sup> C interface. The default voltage is 5V.							
			<b>Code</b>	<b>Voltage</b>	<b>Code</b>	<b>Voltage</b>	<b>Code</b>	<b>Voltage</b>	<b>Code</b>	<b>Voltage</b>
			0000	3.6V	0001	3.7V	0010	3.8V	0011	3.9V
			0100	4V	0101	4.5V	0110	4.6V	0111	4.7V
			1000	4.8V	1001	4.9V	1010	5V	1011	5.1V
			1100	5.2V	1101	5.3V	1110	5.4V	1111	5.5V
EN1			Enable/Disable CH1 when sequence ID is SEO#0. In SEO#0, CH1 is not the power on/off sequence. In other sequence, CH1 is in sequence control and on/off by the pin EN, not by the register bit EN1. 0 : Disable 1 : Enable							
FB2 [2:0]			FB2 regulation voltage can be selected by I <sup>2</sup> C interface. The default voltage is 0.8V.							
			<b>Code</b>	<b>VREF</b>	<b>If Target = 1.8V</b>	<b>If Target = 1V</b>	<b>If Target = 3.3V</b>			
			000	0.72V	1.62V	0.9V	2.97V			
			001	0.74V	1.665V	0.925V	3.0525V			
			010	0.76V	1.71V	0.95V	3.135V			
			011	0.78V	1.755V	0.975V	3.2175V			
			100	0.8V	1.8V	1V	3.3V			
			101	0.82V	1.845V	1.025V	3.3825V			
			110	0.84V	1.89V	1.05V	3.465V			
			111	0.86V	1.935V	1.075V	3.5475V			

Address Name	Register Address	Bit7 (MSB)	Bit6	Bit5	Bit4	Bit3	Bit2	Bit1	Bit0 (LSB)	
A5	0x05	Meaning	FLST	FB3 [2:0]			FLST2	FB4 [2:0]		
		Default	1	1	0	0	1	1	0	0
		Read/Write	R/W	R/W	R/W	R/W	R/W	R/W	R/W	R/W
FLST		Used to control the $\overline{\text{CHG}}$ pin status when the register bit A9. CHGSTEN = 0.								
		1 : $\overline{\text{CHG}}$ = High impedance.								
		0 : $\overline{\text{CHG}}$ = Low.								
FB3 [2:0]		FB3 regulation voltage can be selected by I <sup>2</sup> C interface. The default voltage is 0.8V.								
		<b>Code</b>	<b>VREF</b>	<b>If Target = 1.8V</b>	<b>If Target = 1V</b>	<b>If Target = 3.3V</b>				
		000	0.72V	1.62V	0.9V	2.97V				
		001	0.74V	1.665V	0.925V	3.0525V				
		010	0.76V	1.71V	0.95V	3.135V				
		011	0.78V	1.755V	0.975V	3.2175V				
		100	0.8V	1.8V	1V	3.3V				
		101	0.82V	1.845V	1.025V	3.3825V				
		110	0.84V	1.89V	1.05V	3.465V				
		111	0.86V	1.935V	1.075V	3.5475V				
FLST2		Used to control the $\overline{\text{CHG2}}$ pin status when the register bit A8. CHG2STEN = 0.								
		1 : $\overline{\text{CHG2}}$ = High impedance.								
		0 : $\overline{\text{CHG2}}$ = Low.								
FB4 [2:0]		FB4 regulation voltage can be selected by I <sup>2</sup> C interface. The default voltage is 0.8V.								
		<b>Code</b>	<b>VREF</b>	<b>If Target = 1.8V</b>	<b>If Target = 1V</b>	<b>If Target = 3.3V</b>				
		000	0.72V	1.62V	0.9V	2.97V				
		001	0.74V	1.665V	0.925V	3.0525V				
		010	0.76V	1.71V	0.95V	3.135V				
		011	0.78V	1.755V	0.975V	3.2175V				
		100	0.8V	1.8V	1V	3.3V				
		101	0.82V	1.845V	1.025V	3.3825V				
		110	0.84V	1.89V	1.05V	3.465V				
		111	0.86V	1.935V	1.075V	3.5475V				

Address Name	Register Address	Bit7 (MSB)	Bit6	Bit5	Bit4	Bit3	Bit2	Bit1	Bit0 (LSB)	
A6	0x06	Meaning	VOUT5 [3:0]				VOUT6 [3:0]			
		Default	1	0	0	0	0	0	1	1
		Read/Write	R/W	R/W	R/W	R/W	R/W	R/W	R/W	R/W
VOUT5 [3:0]		CH5 regulation voltage can be selected by I <sup>2</sup> C interface. The default voltage is 1.8V.								
		<b>Code</b>	<b>Voltage</b>	<b>Code</b>	<b>Voltage</b>	<b>Code</b>	<b>Voltage</b>	<b>Code</b>	<b>Voltage</b>	
		0000	REF	0001	1.1V	0010	1.2V	0011	1.3V	
		0100	1.4V	0101	1.5V	0110	1.6V	0111	1.7V	
		1000	1.8V	1001	2V	1010	2.2V	1011	2.3V	
		1100	2.5V	1101	2.6V	1110	2.7V	1111	2.8V	
VOUT6 [3:0]		CH6 regulation voltage can be selected by I <sup>2</sup> C interface. The default voltage is 1.3V.								
		<b>Code</b>	<b>Voltage</b>	<b>Code</b>	<b>Voltage</b>	<b>Code</b>	<b>Voltage</b>	<b>Code</b>	<b>Voltage</b>	
		0000	Switch	0001	1.1V	0010	1.2V	0011	1.3V	
		0100	1.4V	0101	1.5V	0110	1.6V	0111	1.7V	
		1000	1.8V	1001	2V	1010	2.2V	1011	2.5V	
		1100	2.8V	1101	3.1V	1110	3.2V	1111	3.3V	

Address Name	Register Address	Bit7 (MSB)	Bit6	Bit5	Bit4	Bit3	Bit2	Bit1	Bit0 (LSB)															
A7	0x07	Meaning	TIMER [3:0]				ENCH	USUS	ISETU	ISETL														
		Default	0	1	0	0	0	0	0	0														
		Read/Write	R/W	R/W	R/W	R/W	R/W	R/W	R/W	R/W														
TIMER [3:0]		Define fast charger safe charging time. Fast charging timeout time = (TIMER [3:0] + 1) hours. The default voltage is 5 hours. Note : pre-charge timeout time = fast charge time/8.																						
ENCH		Enable charger 0 : Enable charger 1 : Disable charger																						
USUS		VIN Suspend control 0 : No suspend 1 : Suspend																						
ISETU and ISETL		VIN Current limit setting : <table border="1" style="margin-left: 20px;"> <thead> <tr> <th>ISETL</th> <th>ISETU</th> <th>VIN Input Current Limit</th> </tr> </thead> <tbody> <tr> <td>0</td> <td>0</td> <td>85mA (default)</td> </tr> <tr> <td>0</td> <td>1</td> <td>475mA</td> </tr> <tr> <td>1</td> <td>0</td> <td>1A</td> </tr> <tr> <td>1</td> <td>1</td> <td>1.5A</td> </tr> </tbody> </table> Note: When Charger Type Detection finds the charger is Dedicated Charging Port (Sony or Apple Charger), ISETU/ISETL would set to be 475mA automatically.								ISETL	ISETU	VIN Input Current Limit	0	0	85mA (default)	0	1	475mA	1	0	1A	1	1	1.5A
ISETL	ISETU	VIN Input Current Limit																						
0	0	85mA (default)																						
0	1	475mA																						
1	0	1A																						
1	1	1.5A																						

Address Name	Register Address	Bit7 (MSB)	Bit6	Bit5	Bit4	Bit3	Bit2	Bit1	Bit0 (LSB)		
A8	0x08	Meaning	TSHT[1:0]		Mask_DPM	CHG2STEN	ISETA [3:0]				
		Default	0	0	0	1	0	1	0	0	
		Read/Write	R/W	R/W	R/W	R/W	R/W	R/W	R/W	R/W	
TSHT [1:0]		Set TS/VP threshold to monitor battery temperature for HOT boundary.									
		Code	TS/VP ratio	Equivalent Battery Temperature							
				10k NTC		100k NTC					
		00	28%	60°C		60°C					
		01	28.5%	58°C		59°C					
		10	29%	56°C		57°C					
11	29.5%	54°C		56°C							
Mask_DPM		Mask DPM function									
		0 : When DPM event change, $\overline{\text{INT}}$ would be asserted.									
		1 : When DPM event change, $\overline{\text{INT}}$ would not be asserted.									
CHG2STEN		Used to control $\overline{\text{CHG2}}$ pin status.									
		0 : See FLSH2 set.									
		1 : Base on charging status.									
		Charging Status		CHG2STEN = 1 (A8.bit4 = 1)		CHG2STEN = 0 (A8.bit4 = 0)		FLST2 = 1 (A5.bit3 = 1)		FLST2 = 0 (A5.bit3 = 0)	
		No Charging/ Charging Finish		High impedance (No flashing)		High Impedance		Low			
		Pre-Charge/ Fast Charge		Low							
Abnormal (Fault timer timeout, in thermal regulation, battery too cold or too hot)		4Hz (0.25s)									
ISETA [3:0]		RT5016C allows user to set the battery charge current level and the list as below. The default value is 0.5A.									
		Code	BAT Charge Current	Code	BAT Charge Current	Code	BAT Charge Current	Code	BAT Charge Current		
		0000	0.1A	0001	0.2A	0010	0.3A	0011	0.4A		
		0100	0.5A	0101	0.6A	0110	0.7A	0111	0.8A		
		1000	0.9A	1001	1A	1010	1.1A	1011	1.2A		
		1100	1.2A	1101	1.2A	1110	1.2A	1111	1.2A		

Address Name	Register Address		Bit7 (MSB)	Bit6	Bit5	Bit4	Bit3	Bit2	Bit1	Bit0 (LSB)		
A9	0x09	Meaning	$\overline{JEITA}$	VSETH	VSETC	ISETH	ISETC	CHGSTEN	INT	DPM		
		Default	0	0	0	0	0	1	0	0		
		Read/Write	R/W	R/W	R/W	R/W	R/W	R/W	R/W	R/W	R	
$\overline{JEITA}$ , VSETH, VSETC, ISETH, ISETC			BAT charge current and regulation voltage control scheme.									
			$\overline{JEITA} = 0$ , it means the charger operation is automatic ( $\overline{JEITA}$ rule).									
			$\overline{JEITA} = 1$ , User can set the VSETH/VSETC to decide the BAT regulate voltage and set ISETH/ISETC to decide the BAT charge current level. The control scheme is listed as below.									
CHGSTEN			Used to control CHG pin status.									
			0 : See FLSH set.									
			1 : Base on charging status.									
			Charging Status		CHGSTEN = 1 (A9.bit2 = 1)		CHGSTEN = 0 (A9.bit2 = 0)		FLST = 1 (A5.bit7 = 1)		FLST = 0 (A5.bit7 = 0)	
			No Charging/ Charging Finish		High impedance (No flashing)		High Impedance		Low			
Pre-Charge/ Fast Charge		0.5Hz (2s)										
Abnormal (Fault timer timeout, in thermal regulation, battery too cold or too hot)		4Hz (0.25s)										
INT			Control the output of $\overline{INT}$ open drain port. The bit value is inverted of $\overline{INT}$ output. When interrupt events happen, $\overline{INT}$ port goes low and this bit A9. INT would be triggered to 1. Micro-processor must write this bit to be 0 for making $\overline{INT}$ go high.									
			0 : $\overline{INT} = \text{High}$									
			1 : $\overline{INT} = \text{Low}$									
DPM			The DPM bit is the charger VIN DPM status bit. It means the charger DPM (VIN falls and regulates at 4.35V) is activated or not.									
			0 : VIN DPM not activated.									
			1 : VIN DPM activated (working).									
			Note : when PMU turns on, it would check the bit DPM and compare to the value 0. If it is different, $\overline{INT}$ would be asserted. After PMU is on, once DPM bit toggles, $\overline{INT}$ also asserts again.									

Address Name	Register Address	Bit7 (MSB)	Bit6	Bit5	Bit4	Bit3	Bit2	Bit1	Bit0 (LSB)											
A10	0x0A	Meaning	TS_METER [2:0]			NoBAT	EOC	PGOOD	THR	SAFE										
		Default	0	0	0	0	0	0	0	0										
		Read/Write	R	R	R	R	R	R	R	R										
TS_METER [2:0]		<p>Reports the battery temperature and VP status by detecting the TS pin voltage.</p> <div style="text-align: center;"> <p>TS Meter [2:0]</p> <p>VP &lt; 0.8V (VP UVLO) TS Meter [2:0] = 010</p> </div> <p>Note : when PMU turns on, it would check TS_Meter [2:0] and compare to the value 000. If it is different, <math>\overline{\text{INT}}</math> would be asserted. After PMU is on, once any bits of TS_Meter [2:0] toggles, <math>\overline{\text{INT}}</math> also asserts again.</p>																		
NoBAT		<p>Means the battery installed or not.</p> <p>0 : BAT Installed</p> <p>1 : No Battery Installed (TS &gt; 90% of VP)</p> <p>Note : when PMU turns on, it would check the bit NoBAT and compare to the value 0. If it is different, <math>\overline{\text{INT}}</math> would be asserted. After PMU is on, once NoBAT bit toggles, <math>\overline{\text{INT}}</math> also asserts again.</p>																		
EOC		<p>End of charge (EOC) bit show the charge status. If EOC = 1 means the charger is in EOC status.</p> <p>0 : During Charging</p> <p>1 : Charging Done or Recharging after Termination</p> <p>Note: when PMU turns on, it would check the bit EOC and compare to the value 0. If it is different, <math>\overline{\text{INT}}</math> would be asserted. After PMU is on, once EOC bit toggles, <math>\overline{\text{INT}}</math> also asserts again.</p>																		
PGOOD		<p>PGOOD bit means the VIN power status.</p> <table border="1" style="margin-left: auto; margin-right: auto;"> <thead> <tr> <th>Input Status</th> <th>PGOOD Bit Status</th> </tr> </thead> <tbody> <tr> <td>VIN &lt; VUVLO</td> <td>0</td> </tr> <tr> <td>VUVLO &lt; VIN &lt; VBAT + VOS_L</td> <td>0</td> </tr> <tr> <td>VBAT + VOS_H &lt; VIN &lt; VOVP</td> <td>1</td> </tr> <tr> <td>VIN &gt; VOVP</td> <td>0</td> </tr> </tbody> </table> <p>Note : when PMU turns on, it would check the bit PGOOD and compare to the value 0. If it is different, <math>\overline{\text{INT}}</math> would be asserted. After PMU is on, once PGOOD bit toggles, <math>\overline{\text{INT}}</math> also asserts again.</p>									Input Status	PGOOD Bit Status	VIN < VUVLO	0	VUVLO < VIN < VBAT + VOS_L	0	VBAT + VOS_H < VIN < VOVP	1	VIN > VOVP	0
Input Status	PGOOD Bit Status																			
VIN < VUVLO	0																			
VUVLO < VIN < VBAT + VOS_L	0																			
VBAT + VOS_H < VIN < VOVP	1																			
VIN > VOVP	0																			



THR	THR bit can be let user to monitor the thermal regulation function is working or not.
	0 : thermal Regulation is not working
	1 : thermal Regulation is working
	Note : when PMU turn on, it would check the bit THR and compare to the value 0. If it is different, $\overline{INT}$ would be asserted. After PMU is on, once THR bit toggles, $\overline{INT}$ also asserts again.
$\overline{SAFE}$	Charger safety timer status.
	0 : charger in charging or suspended by thermal loop
	1 : safety timer expired
	Note : when PMU turn on, it would check the bit $\overline{SAFE}$ and compare to the value 0. If it is different, $\overline{INT}$ would be asserted. After PMU is on, once $\overline{SAFE}$ bit toggles, $\overline{INT}$ also asserts again.

Address Names	Register Address	Bit7 (MSB)	Bit6	Bit5	Bit4	Bit3	Bit2	Bit1	Bit0 (LSB)	
A11	0x0B	Meaning	CHG_TYP [2:0]			Reserved	Reserved	CHG_2DET	CHG_1DET	CHGRUN
		Default	0	0	0	x	x	1	1	0
		Read/Write	R	R	R	--	--	R/W	R/W	R
CHG_TYP [2:0]	The CHG_TYP [2:0] is used to recode the charger type.									
	<b>Code</b>	<b>Charger Type</b>			<b>Code</b>	<b>Charger Type</b>				
	000	Standard USB CHARGER (SDP)			100	APPLE CHARGER (1A)				
	001	Sony CHARGER -1			101	Nikon CHARGER				
	010	Sony CHARGER -2			110	DEDICATED CHARGER (DCP)				
011	APPLE CHARGER (0.5A)			111	DEDICATED CHARGER (DCP)					
CHG_2DET	The CHG_2DET bit is used to enable the secondary charger detection (to distinguish CDP and DCP). Default value is 0. Set this bit value to 1 in order to enable charger detection.									
	0 : Secondary CHARGER DETECTION DISABLED									
	1 : Secondary CHARGER DETECTION ENABLE.									
CHG_1DET	The CHG_1DET bit is used to enable the primary charger detection. Default value is 1 (auto-detect charger type when VIN plug in). Toggle this bit value (set to 0 and then set 1) to re-enable charger detection.									
	0 : Primary CHARGER DETECTION DISABLED.									
	1 : Primary CHARGER DETECTION ENABLE.									
CHGRUN	The CHGRUN bit is the charger detector status bit. It means the charger detection is running or not.									
	0 : CHARGER DETECTION NOT RUNING.									
	1 : CHARGER DETECTION RUNNING.									
	Note : when PMU turn on, it would check the bit CHGRUN and compare to the value 1. If it is different, $\overline{INT}$ would be asserted. After PMU is on, once CHGRUN bit change from 1 to 0, $\overline{INT}$ also asserts again.									

Address Name	Register Address	Bit7	Bit6	Bit5	Bit4	Bit3	Bit2	Bit1	Bit0	
A0	0x00	Meaning	RST_P	RST_C	OVP7	Reserved	ENDPM	TSD	MOD7	TSSEL
		Default	1	0	0	x	0	0	0	1
		Read/Write	R/W	R/W	R/W	--	R/W	R/W	R	R/W
		Reset Condition	A	A	A	G	A	A	H	A
A1	0x01	Meaning	ERR1	ERR2	ERR3	ERR4	ERR5	ERR6	ERR7	ERR8
		Default	0	0	0	0	0	0	0	0
		Read/Write	R/W	R/W	R/W	R/W	R/W	R/W	R/W	R/W
		Reset Condition	A	A	A	A	A	A	A	A
A2	0x02	Meaning	EN5	EN6	EN8	EN7_DIM7 [4:0]				
		Default	0	0	0	0	0	0	0	0
		Read/Write	R/W	R/W	R/W	R/W	R/W	R/W	R/W	R/W
		Reset Condition	B	B	B	B	B	B	B	B
A3	0x03	Meaning	PSM1	PSM2	PSM3	PSM4	VOUT8 [3:0]			
		Default	1	1	1	1	1	1	0	0
		Read/Write	R/W	R/W	R/W	R/W	R/W	R/W	R/W	R/W
		Reset Condition	C	C	C	C	C	C	C	C
A4	0x04	Meaning	VOUT1 [3:0]			EN1	FB2 [2:0]			
		Default	1	0	1	0	0	1	0	0
		Read/Write	R/W	R/W	R/W	R/W	R/W	R/W	R/W	R/W
		Reset Condition	C	C	C	C	B	C	C	C
A5	0x05	Meaning	FLST	FB3[2:0]		FLST2	FB4[2:0]			
		Default	1	1	0	0	1	1	0	0
		Read/Write	R/W	R/W	R/W	R/W	R/W	R/W	R/W	R/W
		Reset Condition	C	C	C	C	C	C	C	C
A6	0x06	Meaning	VOUT5 [3:0]			VOUT6 [3:0]				
		Default	1	0	0	0	0	0	1	1
		Read/Write	R/W	R/W	R/W	R/W	R/W	R/W	R/W	R/W
		Reset Condition	C	C	C	C	C	C	C	C
A7	0x07	Meaning	TIMER [3:0]			ENCH	USUS	ISSETU	ISSETL	
		Default	0	1	0	0	0	0	0	
		Read/Write	R/W	R/W	R/W	R/W	R/W	R/W	R/W	
		Reset Condition	D	D	D	D	D	D	D	

Address Name	Register Address	Bit7	Bit6	Bit5	Bit4	Bit3	Bit2	Bit1	Bit0	
A8	0x08	Meaning	TSHT [1:0]		Mask_DPM	CHG2STEN	ISETA [3:0]			
		Default	0	0	0	1	0	1	0	0
		Read/Write	R/W	R/W	R/W	R/W	R/W	R/W	R/W	R/W
		Reset Condition	D	D	D	D	D	D	D	D
A9	0x09	Meaning	$\overline{JEITA}$	VSETH	VSETC	ISETH	ISETC	CHGSTEN	INT	DPM
		Default	0	0	0	0	0	1	0	0
		Read/Write	R/W	R/W	R/W	R/W	R/W	R/W	R/W	R
		Reset Condition	D	D	D	D	D	D	E	D
A10	0x0A	Meaning	TS_METER [2:0]			NoBAT	EOC	PGOOD	THR	SAFE
		Default	0	0	0	0	0	0	0	0
		Read/Write	R	R	R	R	R	R	R	R
		Reset Condition	I	I	I	I	J	J	J	J
A11	0x0B	Meaning	CHG_TYP [2:0]			Reserved	Reserved	CHG_2DET	CHG_1DET	CHGRUN
		Default	0	0	0	x	x	0	1	0
		Read/Write	R	R	R	--	--	R/W	R/W	R
		Reset Condition	K	K	K	G	G	F	F	L

I<sup>2</sup>C register reset condition :

- A. In addition to A0.bit 1 and A0.bit4, the bits of A0 and A1 (register 0x0, 0x1) reset only when (VRTC < 1.6V).
- B. The bits of A2 (register 0x2) and A4.bit3 reset when (EN pin = low) or (VDDI < 2.4V) or (BAT < 1.3V) or (Temperature > 125°C)
- C. In addition to A4.bit3, PMU settings (A3 to A6, register 0x3 to 0x6) reset when (EN pin = low and A0.RST\_P = 1) or (VDDI < 1.3V)

VDDI < 1.3V	EN pin	A0.RST_P bit	==>	Reset PMU Setting
TRUE	x	x (don't care)		Reset
False (VDDI > 1.3V)	Low	1		Reset
	High	1		Not reset
	Low	0		Not reset
	High	0		Not reset

- D. In addition to A9.bit 1, charger settings (A7 to A9, registers (0x7 to 0x9) reset when (VIN < 4V) or (VDDI < 1.3V) or ((BAT < 3.1V) and (A0.RST\_C = 1))

VDDI < 1.3V	VIN > 4V	A0.RST_C bit	(BAT < 3.1V)	==>	Reset Charger Setting
true (VDDI < 1.3V)	x	x	x		Reset
false (VDDI > 1.3V)	False (VIN < 4V)	x	x		Reset
false (VDDI > 1.3V)	True (VIN > 4V)	1	TRUE		Reset
false (VDDI > 1.3V)	True (VIN > 4V)	1	FALSE		Not reset
false (VDDI > 1.3V)	True (VIN > 4V)	0	TRUE		Not reset
false (VDDI > 1.3V)	True (VIN > 4V)	0	FALSE		Not reset

E. (EN pin = low) or (VDDI < 1.3V)

F. Charger type detection A11 (registers 0xB) reset when (VIN < 4V) or (VDDI < 1.3V)

G. Always reset.

H. A0.bit1 will be reset when (EN pin = low) or (VDDI < 2.4V) or (BAT < 1.3V) or (PMU protection occur) or (Temperature < 125°C).

I. A0.bit1 will be reset when (EN pin = low) or (VDDI < 2.4V) or (BAT < 1.3V) or (In addition to CH7 OVP, PMU protection occur) or (Temperature < 125°C).

J. Reference page-54 A10 explanation.

K. A11.bit7 to bit5 will be rewritten after charging type detects finish.

L. A11.bit0 keeps high during charging type detecting.

### CHG Signal Status

Charging Status	CHG			CHG2		
	CHGSTEN = 1	CHGSTEN = 0		CHG2STEN = 1	CHG2STEN = 0	
		A5. bit7 = 1	A5. bit7 = 0		A5. bit3 = 1	A5. bit3 = 0
No Charging/Charging Finish	High impedance (No flashing)	High impedance	Low	High impedance (No flashing)	High impedance	Low
Pre-Charge/Fast Charge	0.5Hz (2s)			Low		
Abnormal (Fault timer timeout, in thermal regulation, battery too cold or too hot)	4Hz (0.25s)			4Hz(0.25s)		

**NTC Thermistor Order Detection**

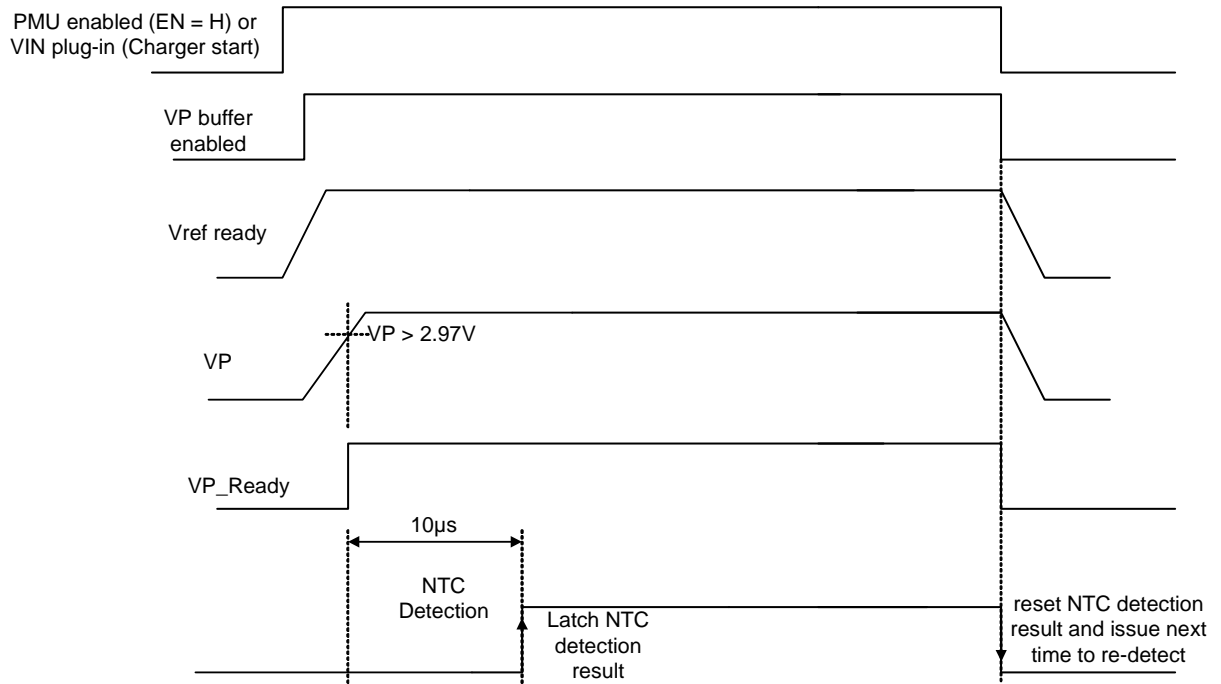

USB Charger Detection

Charger Type Detection : Detection Time ≤ 600ms

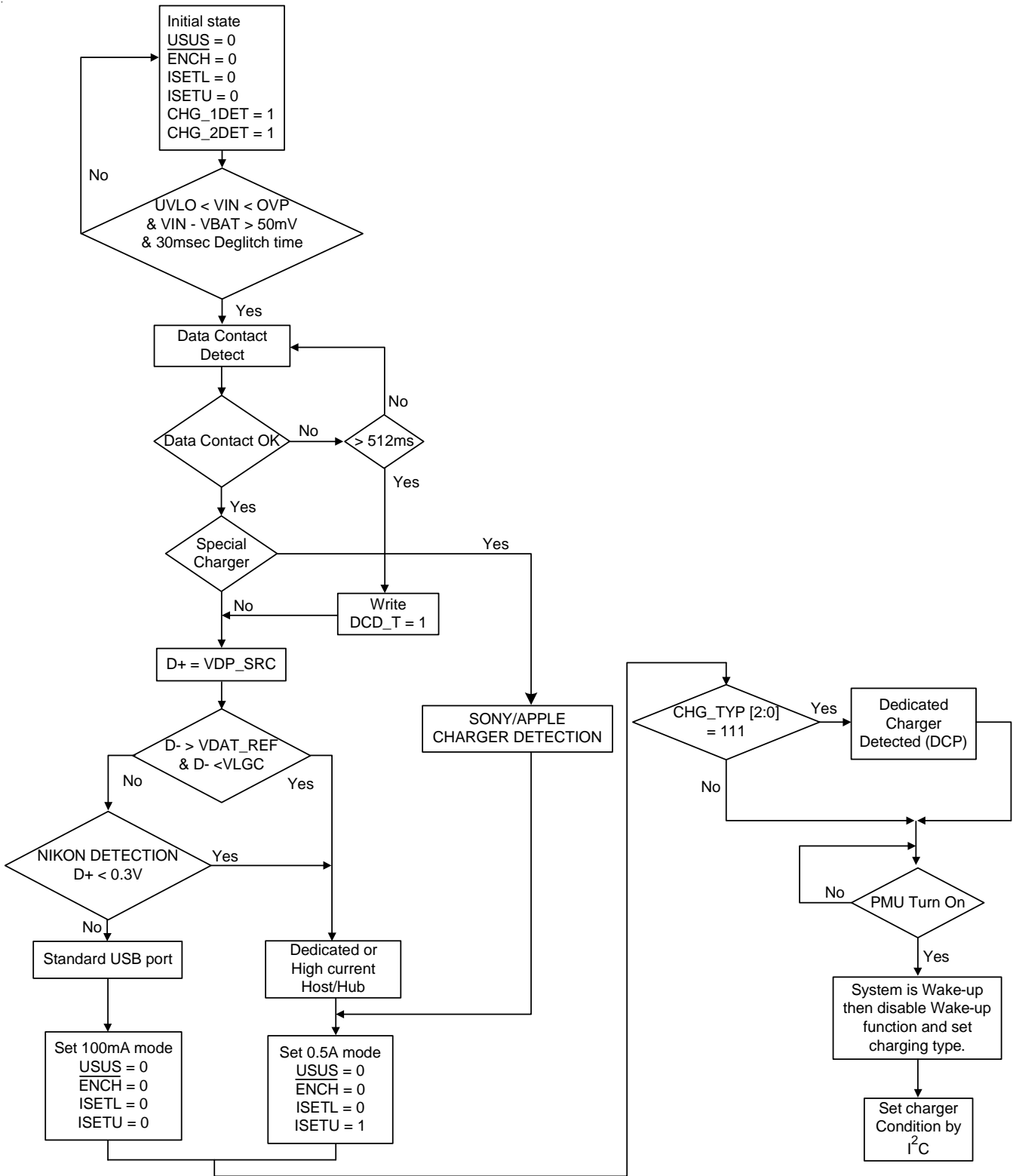

D+/D- impedance of Standard USB Host, Apple Charger, Sony Charger, and Dedicated Charger :

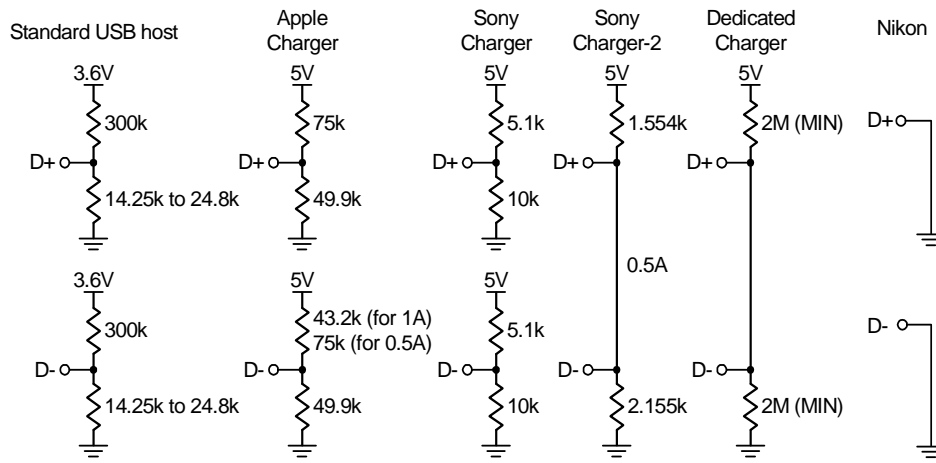

### Thermal Considerations

For continuous operation, do not exceed absolute maximum junction temperature. The maximum power dissipation depends on the thermal resistance of the IC package, PCB layout, rate of surrounding airflow, and difference between junction and ambient temperature. The maximum power dissipation can be calculated by the following formula :

$$P_{D(MAX)} = (T_{J(MAX)} - T_A) / \theta_{JA}$$

where  $T_{J(MAX)}$  is the maximum junction temperature,  $T_A$  is the ambient temperature, and  $\theta_{JA}$  is the junction to ambient thermal resistance.

For recommended operating condition specifications, the maximum junction temperature is 125°C. The junction to ambient thermal resistance,  $\theta_{JA}$ , is layout dependent. For WQFN-40L 5x5 package, the thermal resistance,  $\theta_{JA}$ , is 27.5°C/W on a standard JEDEC 51-7 four-layer thermal test board. The maximum power dissipation at  $T_A = 25^\circ\text{C}$  can be calculated by the following formula :

$$P_{D(MAX)} = (125^\circ\text{C} - 25^\circ\text{C}) / (27.5^\circ\text{C}/\text{W}) = 3.63\text{W for WQFN-40L 5x5 package}$$

The maximum power dissipation depends on the operating ambient temperature for fixed  $T_{J(MAX)}$  and thermal resistance,  $\theta_{JA}$ . The derating curve in Figure 6 allows the designer to see the effect of rising ambient temperature on the maximum power dissipation.

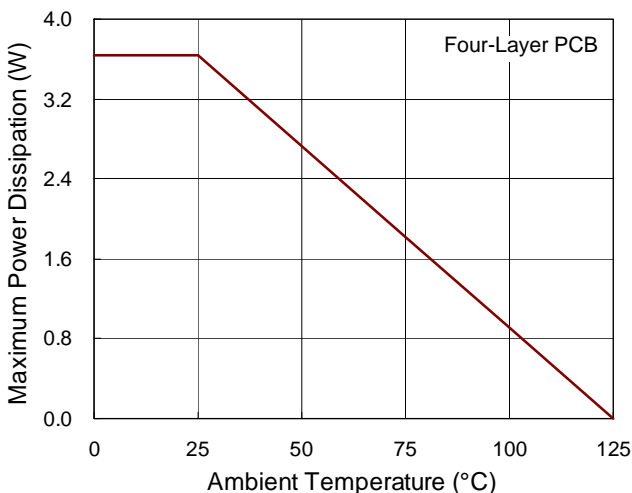

Figure 6. Derating Curve of Maximum Power Dissipation

### Layout Consideration

For the best performance of the RT5016C, the following PCB layout guidelines must be strictly followed.

- ▶ Place the input and output capacitors as close as possible to the input and output pins respectively for good filtering.
- ▶ Keep the main power traces as wide and short as possible.
- ▶ The switching node area connected to LX and inductor should be minimized for lower EMI.
- ▶ Place the feedback components as close as possible to the FB pin and keep these components away from the noisy devices.
- ▶ Connect the GND and Exposed Pad to a strong ground plane for maximum thermal dissipation and noise protection.
- ▶ To make CH1 and whole chip stable, the power path from the PVD1 pin to its output capacitors must be as short ( $\leq 1\text{mm}$  is better) and wide as possible.
- ▶ To make CH4 and CH5 stable, the power path from the PVD45 pin to its input capacitors must be as short ( $\leq 1\text{mm}$  is better) and wide as possible.



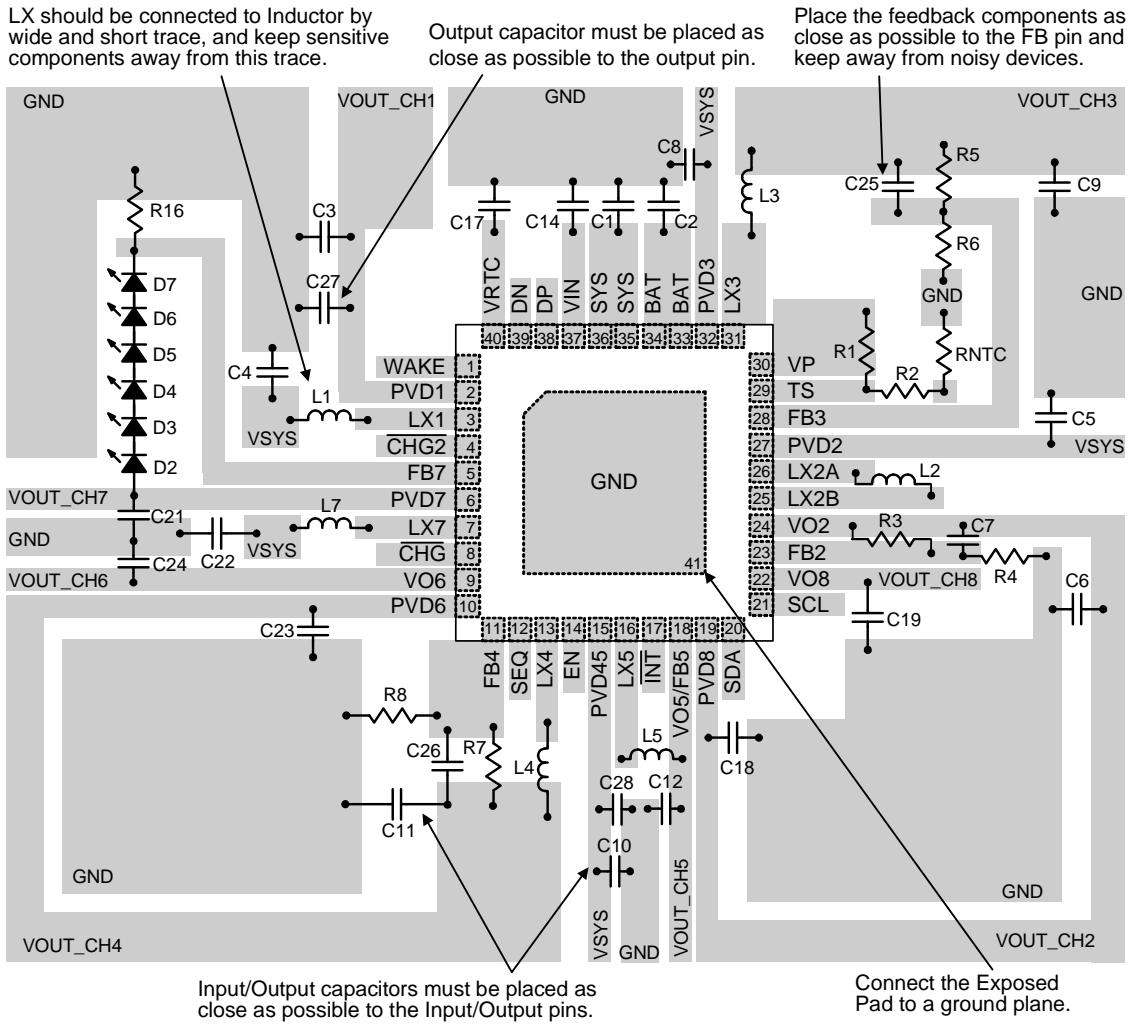
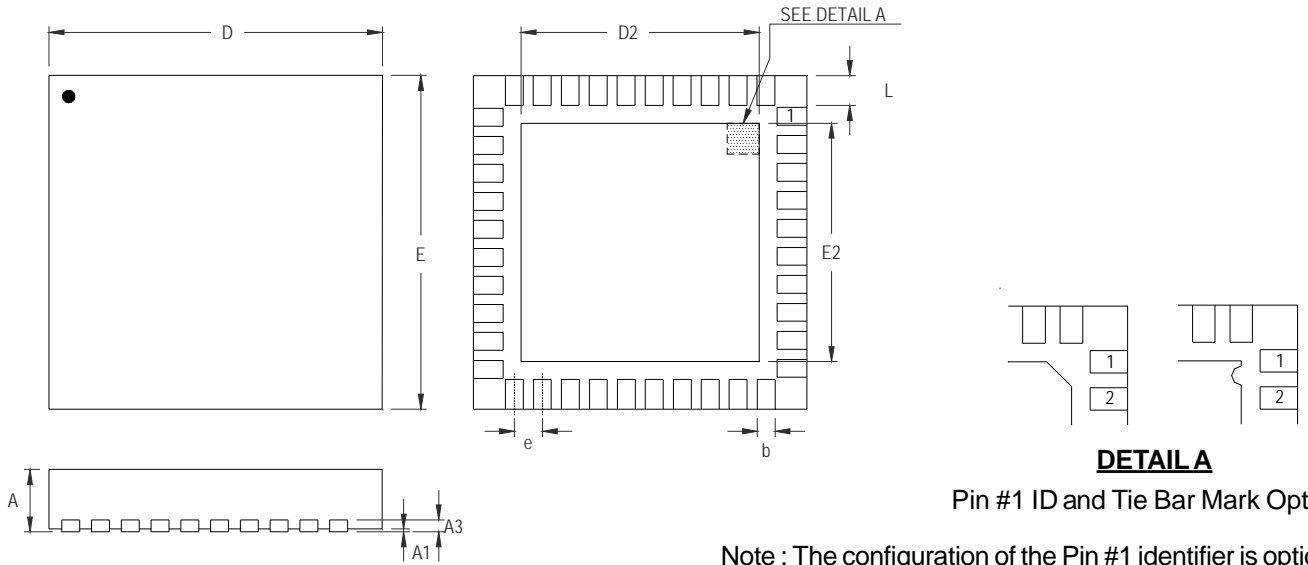

Figure 7. PCB Layout Guide

	Protection Type	Threshold (Typical) Refer to Electrical Spec.	Protection Methods	PMU Shutdown Delay Time	Reset Method
SYS	UVLO	SYS < 1.5V	PMU Shutdown.	No-delay	EN1234 pin set to low or SYS > 2.1V
VDDI	OVP	VDDM > 6V	Automatic reset at VDDM < 5.85V	100ms	VDDI power reset or EN1234 pin set to low
	UVLO	VDDM < 2.4V	PMU Shutdown.	No-delay	VDDI power reset or EN1234 pin set to low
CH1 Step-Up	Current Limit	N-MOSFET peak current > 3A	N-MOSFET off, P-MOSFET off. Automatic reset at next clock cycle.	100ms	VDDI power reset or EN1234 pin set to low
	PVD1 OVP	PVDD1 > 6V	N-MOSFET off, P-MOSFET off.	No-delay	VDDI power reset or EN1234 pin set to low
	PVD1 UVP --1	PVDD1 < (VSYS – 0.8V) or PVDD1 < 1.28V after soft-start end.	N-MOSFET off, P-MOSFET off.	100ms	VDDI power reset or EN1234 pin set to low
	PVD1 UVP --2	After pre-charge (PVD1 UVP-2 : FB1 < 0.4V after pre-charge)	N-MOSFET off, P-MOSFET off	No-delay	VDDI power reset or EN1234 pin set to low
	PVD1 Over Load (OL)	Target – 0.6V Target Voltage is defined in A4.VOUT1 [3:0]	PMU Shutdown when OL occur each cycle until 100ms.	100ms	VDDI power reset or EN1234 pin set to low
CH2 Step-Up/Down	Current limit	Both P-MOSFET (PVD2 – LX2A) and N-MOSFET (LX2B – GND) peak current > 2A	N-MOSFET off, P-MOSFET off. Automatic reset at next clock cycle.	100ms	VDDI power reset or EN1234 pin set to low
	VO2 OVP	PVDD1 > 6V	N-MOSFET off, P-MOSFET off.	No-delay	VDDI power reset or EN1234 pin set to low
	FB2 UVP	FB2 < 0.4V after soft-start end.	N-MOSFET off, P-MOSFET off.	No-delay	VDDI power reset or EN1234 pin set to low
	FB2 Over Load	Target – 0.1V (Target voltage is the chosen one in A4.FB2 [2:0])	PMU Shutdown when OL occur each cycle until 100ms.	100ms	VDDI power reset or EN1234 pin set to low
CH3 Step-Down	Current limit	P-MOSFET peak current > 1.8A	N-MOSFET off, P-MOSFET off. Automatic reset at next clock cycle.	100ms	VDDI power reset or EN1234 pin set to low
	FB3 UVP	FB3 < 0.4V after soft-start end.	N-MOSFET off, P-MOSFET off.	No-delay	VDDI power reset or EN1234 pin set to low
	FB3 Over Load	Target – 0.1V (Target voltage is the chosen one in A5.FB3 [2:0])	PMU Shutdown when OL occur each cycle until 100ms.	100ms	VDDI power reset or EN1234 pin set to low

	Protection Type	Threshold (Typical) Refer to Electrical Spec.	Protection Methods	PMU Shutdown Delay Time	Reset Method
CH4 Step-Down	Current limit	P-MOSFET peak current > 1.8A	N-MOSFET off, P-MOSFET off. Automatic reset at next clock cycle.	100ms	VDDI power reset or EN1234 pin set to low
	FB4 UVP	FB4 < 0.4V after soft-start end.	N-MOSFET off, P-MOSFET off.	No-delay	VDDI power reset or EN1234 pin set to low
	FB4 Over Load	Target – 0.1V (Target voltage is the chosen one in A5.FB4 [2:0])	PMU Shutdown when OL occur each cycle until 100ms.	100ms	VDDI power reset or EN1234 pin set to low
CH5 Step-Down	Current limit	P-MOSFET peak current > 1.5A	N-MOSFET off, P-MOSFET off. Automatic reset at next clock cycle.	100ms	VDDI power reset or EN1234 pin set to low
	VO5 UVP	FB5 < 0.4V after soft-start end	N-MOSFET off, P-MOSFET off.	No-delay	VDDI power reset or EN1234 pin set to low
	VO5 Over Load	Target voltage is the chosen one in A6.VOUT5 [3:0] = 0000 (FB5 = 0.8V)	PMU Shutdown when OL occur each cycle until 100ms.	100ms	VDDI power reset or EN1234 pin set to low
Target voltage is the chosen one in A6.VOUT5 [3:0] = 0001 to 0111					
Target voltage is the chosen one in A6.VOUT5 [3:0] = 0111 to 1111					
CH6 LDO	Max. output current (current limit)	P-MOSFET current > 0.45A (PVD6 = 1.5V, VO6 = 1.3V)	P-MOSFET off.	100ms	VDDI power reset or EN1234 pin set to low
CH7 WLED	Current limit (Step-Up mode)	N-MOSFET current > 0.8A	N-MOSFET off, P-MOSFET off. Automatic reset at next clock cycle.	100ms	VDDI power reset or EN1234 pin set to low
	PVDD7 OVP	PVDD7 > 16V (A0.OVP7 = 0)	N-MOSFET off, P-MOSFET off. Shutdown CH7 by self	No-delay	VDDI power reset and A2.EN7_DIM7 [4:0] reset or EN1234 pin set to low
PVDD7 > 25V (A0.OVP7 = 1)					
CH8 LDO	Max. output current (current limit)	P-MOSFET current > 0.45A (PVD6 = 3V, VO6 = 2.5V)	P-MOSFET off.	100ms	VDDI power reset or EN1234 pin set to low
Thermal	Thermal shutdown	Temperature > 155°C	All channels stop switching	No-delay	Temperature < (155 – 20)°C
VIN	VIN UVLO	VIN < 3.3V	No-charge	No-delay	No latch
	VIN OVP	VIN > 6.5V	No-charge	No-delay	No latch

Outline Dimension



Pin #1 ID and Tie Bar Mark Options

Note : The configuration of the Pin #1 identifier is optional, but must be located within the zone indicated.

Symbol	Dimensions In Millimeters		Dimensions In Inches	
	Min	Max	Min	Max
A	0.700	0.800	0.028	0.031
A1	0.000	0.050	0.000	0.002
A3	0.175	0.250	0.007	0.010
b	0.150	0.250	0.006	0.010
D	4.950	5.050	0.195	0.199
D2	3.250	3.500	0.128	0.138
E	4.950	5.050	0.195	0.199
E2	3.250	3.500	0.128	0.138
e	0.400		0.016	
L	0.350	0.450	0.014	0.018

W-Type 40L QFN 5x5 Package

Richtek Technology Corporation

14F, No. 8, Tai Yuen 1<sup>st</sup> Street, Chupei City  
 Hsinchu, Taiwan, R.O.C.  
 Tel: (8863)5526789

Richtek products are sold by description only. Richtek reserves the right to change the circuitry and/or specifications without notice at any time. Customers should obtain the latest relevant information and data sheets before placing orders and should verify that such information is current and complete. Richtek cannot assume responsibility for use of any circuitry other than circuitry entirely embodied in a Richtek product. Information furnished by Richtek is believed to be accurate and reliable. However, no responsibility is assumed by Richtek or its subsidiaries for its use; nor for any infringements of patents or other rights of third parties which may result from its use. No license is granted by implication or otherwise under any patent or patent rights of Richtek or its subsidiaries.