

## 3A, Ultra-Low Dropout Voltage Regulator

### General Description

The RT9059 is a high performance positive voltage regulator designed for applications requiring very low input voltage and very low dropout voltage at up to 3A. It operates with a VIN as low as 1V and VDD voltage 3V with programmable output voltage as low as 0.8V. The RT9059 features ultra low dropout which makes it, ideal for applications where VOUT is very close to VIN. Additionally, the RT9059 has an enable pin to further reduce power dissipation during shutdown. The RT9059 provides excellent regulation over variations in line, load and temperature. The RT9059 also provides a power good signal to indicate if the voltage level of VO reaches 90% of its rating value.

### Features

- Output Current up to 3A
- High Accuracy ADJ Voltage 1.5%
- Dropout Voltage 350mV @ 3A Typically
- VOUT Power Good Signal
- VOUT Pull Low Resistance when Disabled
- Current-Limit-Protection
- Thermal Shutdown Protection

### Applications

- Notebook PC Applications
- Motherboard Applications

### Ordering and Marking Information

Version (Adjustable Output Fixed Output Voltage Code)	Product Code	Lead Plating System	Package		Fixed Output Voltage Accuracy		VDD Pin Shutdown current Max.	
			WDFN-10L 3x3 (W-Type)	SOP-8 (Exposed Pad-Option 1)	±1.5%	±1%	1μA	30μA
RT9059GQW	0Q=	G : Green ( Halogen Free and Pb Free)	V		V		V	
RT9059-15GQW	1E=		V		V		V	
RT9059-18GQW	18=		V		V		V	
RT9059-25GQW	8F=		V		V		V	
RT9059GSP	RT9059GSP		V		V		V	
RT9059-15GSP	RT905915GSP		V		V		V	
RT9059-18GSP	RT905918GSP		V		V		V	
RT9059-25GSP	RT905925GSP		V		V		V	
RT9059AGQW	4S=		V		V			V
RT9059BGQW	PS=		V			V	V	
RT9059CN-A	V1=		V		V		V	

Note :

Richtek products are Richtek Green Policy compliant and compatible with the current requirements of IPC/JEDEC J-STD-020.

## Pin Configuration

(TOP VIEW)

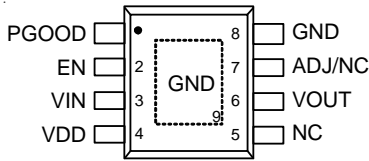

SOP-8 (Exposed Pad)

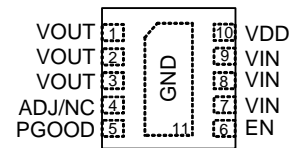

WDFN-10L 3x3

## Typical Application Circuit

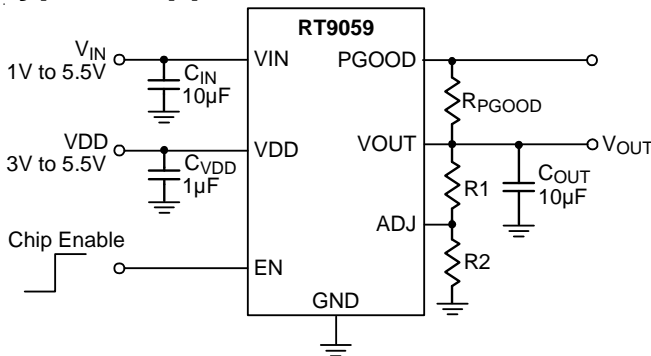

$$V_{OUT} = 0.8 \times (R1+R2)/R2$$

Figure 1. Adjustable Voltage Regulator

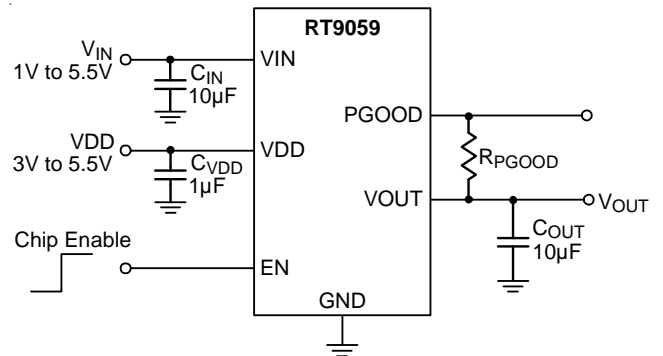
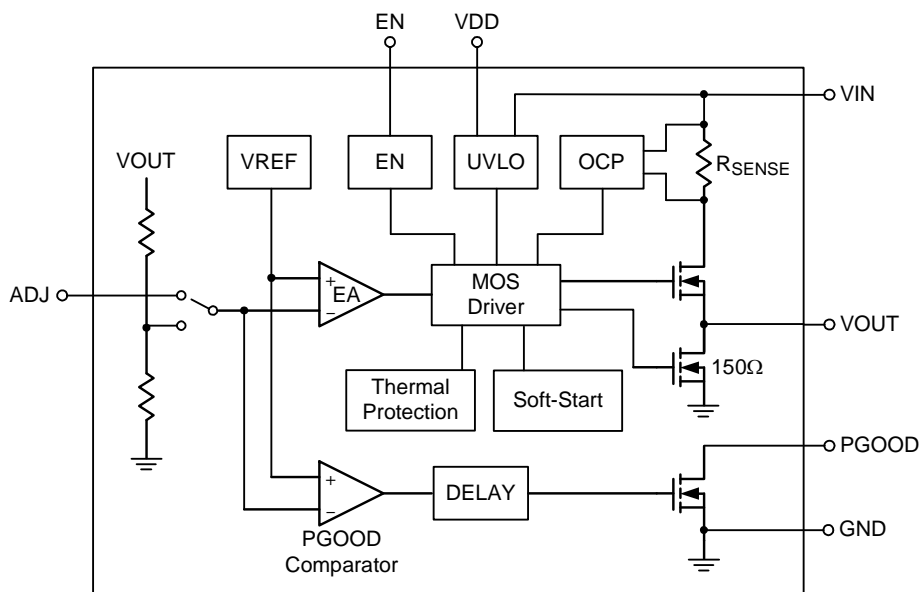

Figure 2. Fixed Voltage Regulator

## Functional Pin Description

Pin No.				Pin Name	Pin Function
SOP-8 (Exposed Pad)		WDFN-10L 3x3			
Adjustable Output Voltage	Fixed Output Voltage	Adjustable Output Voltage	Fixed Output Voltage		
1	1	5	5	PGOOD	Power good open drain output.
2	2	6	6	EN	Enable control input.
3	3	7, 8, 9	7, 8, 9	VIN	Supply input voltage.
4	4	10	10	VDD	Supply voltage of control circuit.
5	5, 7	--	4	NC	No internal connection.
6	6	1, 2, 3	1, 2, 3	VOUT	Output voltage.
7	--	4	--	ADJ	Output voltage setting. $V_{OUT} = V_{REF} \times (R1+R2)/R2$ .
8, 9 (Exposed Pad)	8, 9 (Exposed Pad)	11 (Exposed Pad)	11 (Exposed Pad)	GND	Ground. The exposed pad must be soldered to a large PCB and connected to GND for maximum power dissipation.

**Functional Block Diagram**



## Absolute Maximum Ratings (Note 1)

- Supply Input Voltage, VIN to GND
  - DC ----- -0.3V to 6V
  - < 10ms ----- -0.3V to 7V
- Control Voltage, VDD to GND
  - DC ----- -0.3V to 6V
  - < 10ms ----- -0.3V to 7V
- Output Voltage, VOUT ----- -0.3V to 6V
- Chip Enable Voltage, EN ----- -0.3V to 6V
- Adjust Voltage, ADJ ----- -0.3V to 6V
- Power Good Voltage, VPGOOD ----- -0.3V to 6V
- Power Dissipation, PD @ TA = 25°C
  - SOP-8 (Exposed Pad) ----- 3.08W
  - WDFN-10L 3x3 ----- 3.04W
- Package Thermal Resistance (Note 2)
  - SOP-8 (Exposed Pad), θJA ----- 32.4°C/W
  - SOP-8 (Exposed Pad), θJC ----- 6.5°C/W
  - WDFN-10L 3x3, θJA ----- 32.8°C/W
  - WDFN-10L 3x3, θJC ----- 5.9°C/W
- Junction Temperature ----- 150°C
- Lead Temperature (Soldering, 10 sec.) ----- 260°C
- Storage Temperature Range ----- -65°C to 150°C
- ESD Susceptibility (Note 3)
  - HBM (Human Body Model) ----- 2kV
  - MM (Machine Model) ----- 200V

## Recommended Operating Conditions (Note 4)

- Supply Input Voltage, VIN ----- 1V to 5.5V
- Control Voltage, VDD (VDD > VOUT + 1.5V) ----- 3V to 5.5V
- Junction Temperature Range ----- -40°C to 125°C
- Ambient Temperature Range ----- -40°C to 85°C

## Electrical Characteristics

(VDD = 5V, CIN = COUT = 10μF, CVDD = 1μF, TA = 25°C, unless otherwise specified)

Parameter	Symbol	Test Conditions	Min	Typ	Max	Unit
VDD Operation Range	VDD		3	--	5.5	V
VDD POR Threshold	VPOR_VDD	VDD rising	2.4	2.7	3	V
VDD POR Falling Hysteresis	ΔVPOR_VDD	VDD falling	0.15	0.2	--	V
Input Voltage Range	VIN		1	--	5.5	V
VIN POR Threshold	VPOR_VIN	VIN rising	0.7	0.8	0.9	V
VIN POR Falling Hysteresis	ΔVPOR_VIN	VIN falling	0.15	0.2	0.25	V
Quiescent Current	IQ	EN on, no load	--	0.6	1.2	mA

Parameter	Symbol	Test Conditions	Min	Typ	Max	Unit	
Reference Voltage	V <sub>REF</sub>		0.788	0.8	0.812	V	
Fixed Output Voltage Accuracy		RT9059 series, RT9059A	-1.5	--	1.5	%	
		RT9059B	-1	--	1		
V <sub>OUT</sub> Load Regulation	ΔV <sub>LOAD</sub>	I <sub>OUT</sub> = 1mA to 3A, V <sub>IN</sub> = V <sub>OUT</sub> + 1V	--	0.5	1	%	
OUT Line Regulation	ΔV <sub>LINE</sub>	V <sub>DD</sub> = 3.6V to 5.5V, V <sub>IN</sub> = V <sub>OUT</sub> + 1V to 5V, I <sub>OUT</sub> = 1mA	--	0.2	0.6	%	
Dropout Voltage	V <sub>DROP</sub>	I <sub>OUT</sub> = 2A	--	250	350	mV	
		I <sub>OUT</sub> = 3A	--	350	450		
Current Limit	I <sub>LIM</sub>	V <sub>IN</sub> = 3.6V	3.1	3.6	4.2	A	
Short Circuit Current	I <sub>SC</sub>	V <sub>OUT</sub> < 0.2V	1	1.4	1.8	A	
V <sub>OUT</sub> Pull Low Resistance	R <sub>PULL</sub>	V <sub>EN</sub> = 0V	--	150	--	Ω	
Thermal Shutdown Temperature	T <sub>SD</sub>		--	160	--	°C	
Thermal Shutdown Recovery Temperature	T <sub>SDR</sub>		--	90	--	°C	
PGOOD Rising Threshold	V <sub>TH_PGOOD</sub>	V <sub>OUT</sub> rising	--	90	--	%	
PGOOD Hysteresis	ΔV <sub>TH_PGOOD</sub>	V <sub>OUT</sub> falling	--	10	--	%	
PGOOD Delay Time			0.2	1	1.5	ms	
PGOOD Sink Capability	V <sub>PGOOD</sub>	I <sub>SINK</sub> = 10mA	--	0.2	0.4	V	
EN Input Voltage	Logic-High	V <sub>IH</sub>	1.2	--	--	V	
	Logic-Low	V <sub>IL</sub>	--	--	0.4		
EN Delay Time			0.3	0.85	1.4	ms	
EN Pin Bias Current	I <sub>EN</sub>	V <sub>EN</sub> = 5V	--	12	--	μA	
V <sub>DD</sub> Pin Shutdown Current	I <sub>SHDN_VDD</sub>	V <sub>EN</sub> = 0V	RT9059 series, RT9059B	--	--	1	μA
			RT9059A	--	15	30	
V <sub>IN</sub> Pin Shutdown Current	I <sub>SHDN_VIN</sub>	V <sub>EN</sub> = 0V, V <sub>IN</sub> = 5V	--	--	1	μA	
Inrush Current	I <sub>INRUSH</sub>	V <sub>OUT</sub> = 1.8V, C <sub>OUT</sub> = 10μF, I <sub>LOAD</sub> = 1A	--	0.5	--	A	
Soft-Start Time	t <sub>SS</sub>		1.9	2.8	3.75	ms	

**Note 1.** Stresses beyond those listed “Absolute Maximum Ratings” may cause permanent damage to the device. These are stress ratings only, and functional operation of the device at these or any other conditions beyond those indicated in the operational sections of the specifications is not implied. Exposure to absolute maximum rating conditions may affect device reliability.

**Note 2.** θ<sub>JA</sub> is measured at T<sub>A</sub> = 25°C on a high effective thermal conductivity four-layer test board per JEDEC 51-7. θ<sub>JC</sub> is measured at the exposed pad of the package.

**Note 3.** Devices are ESD sensitive. Handling precautions are recommended.

**Note 4.** The device is not guaranteed to function outside its operating conditions.

Typical Operating Characteristics

Quiescent Current vs. Temperature

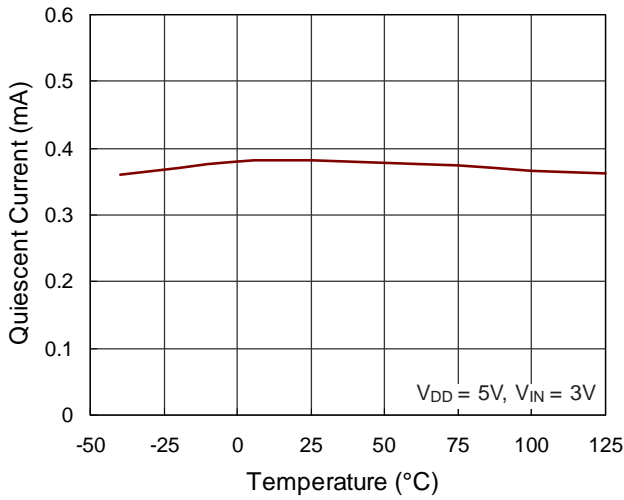

Current Limit vs. Temperature

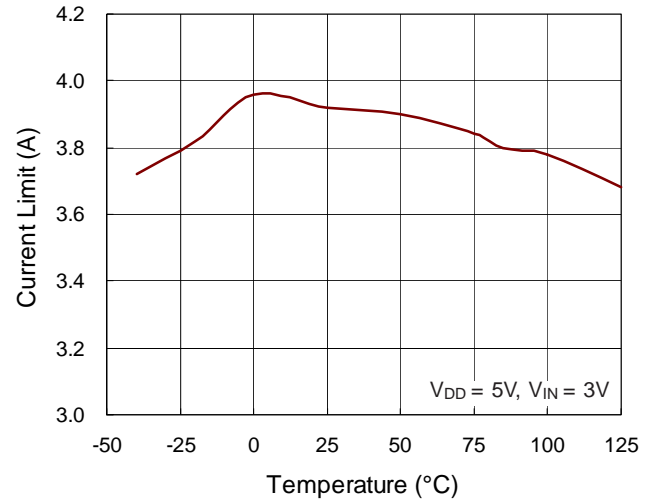

Dropout Voltage vs. Temperature

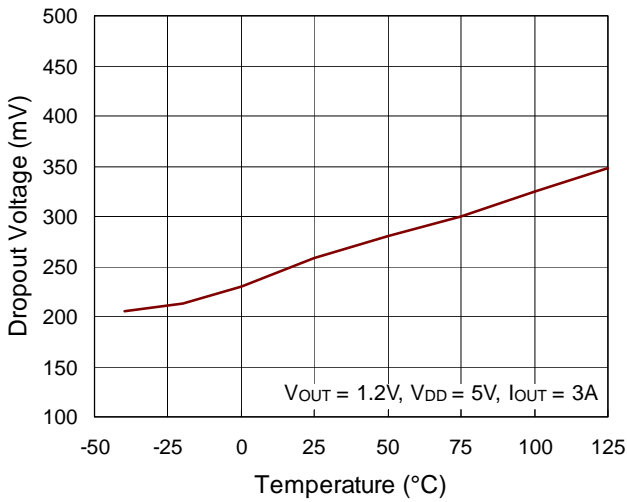

VREF Voltage vs. Temperature

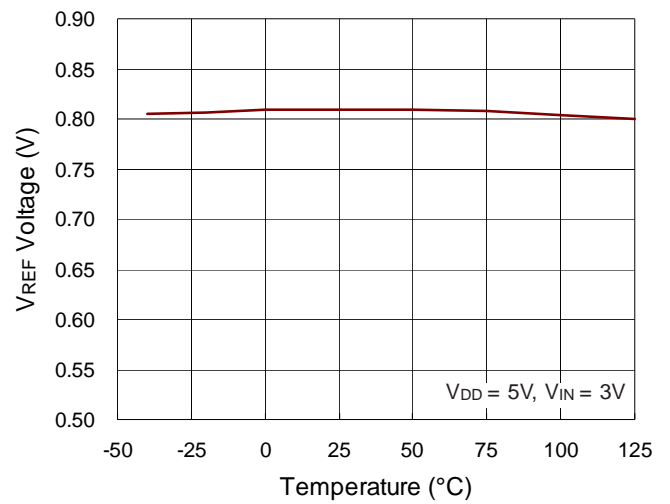

PGOOD Delay Time vs. Temperature

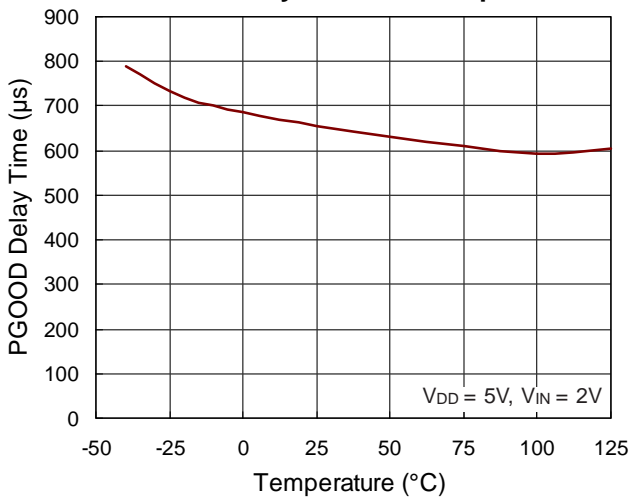

EN Threshold Voltage vs. Temperature

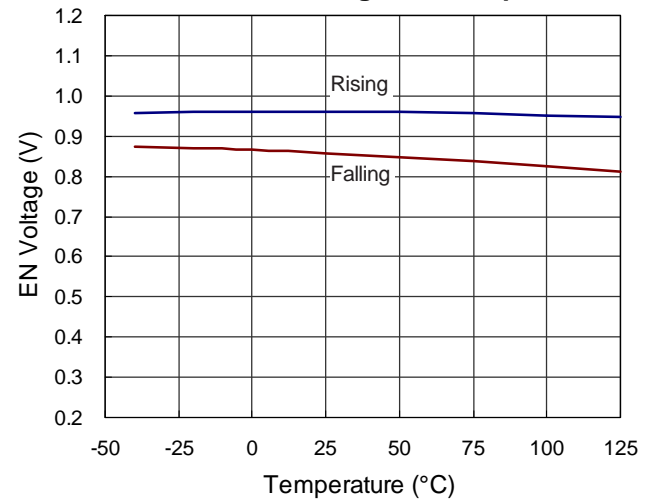

**VDD POR Threshold Voltage vs. Temperature**

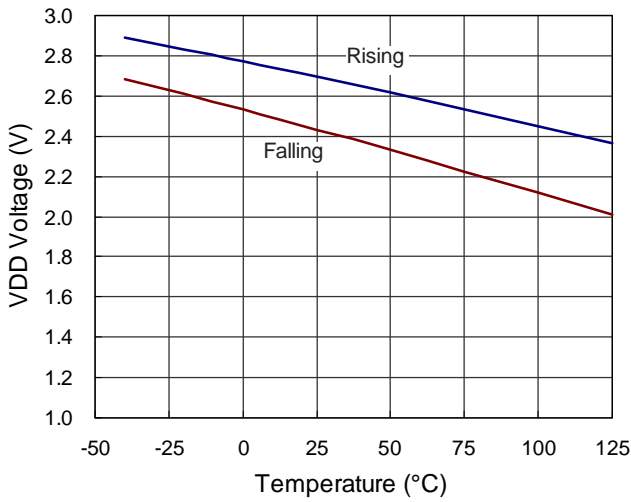

**Dropout Voltage vs. Load Current**

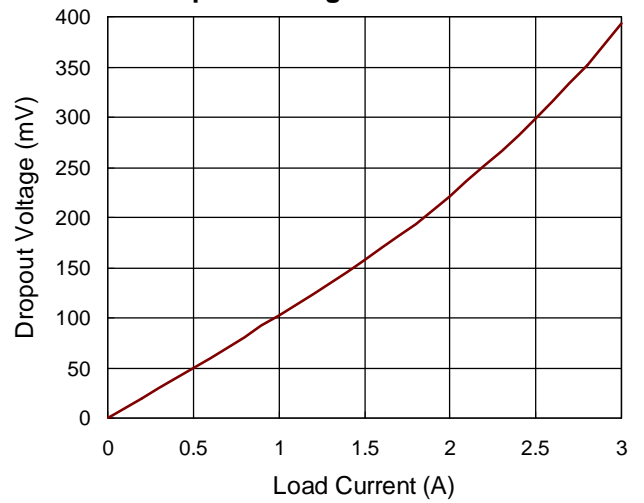

**PSRR vs. Frequency**

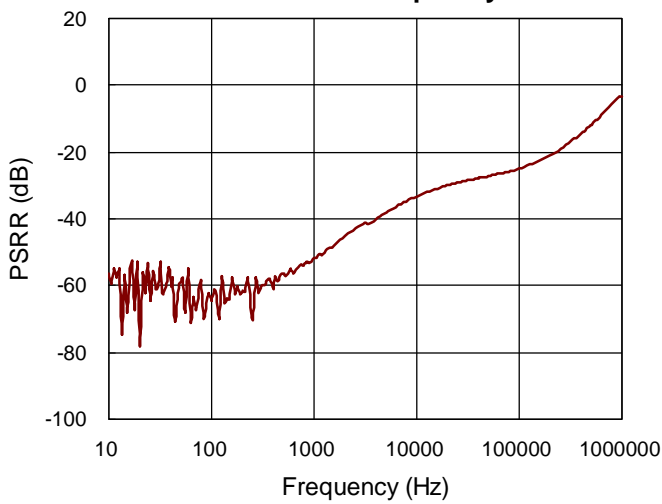

**Load Transient Response**

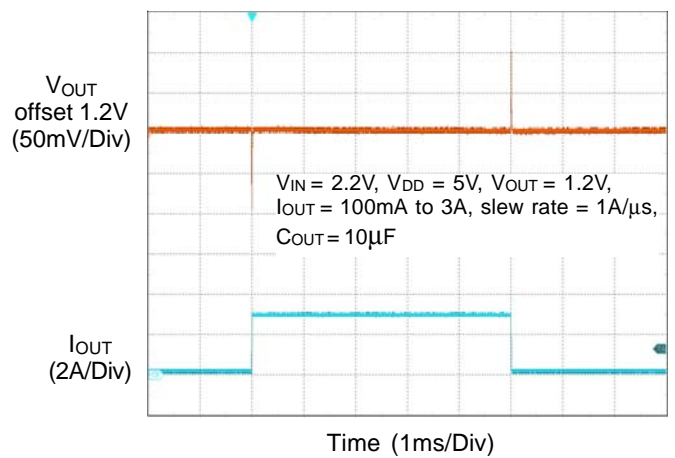

**V<sub>IN</sub> Line Transient Response**

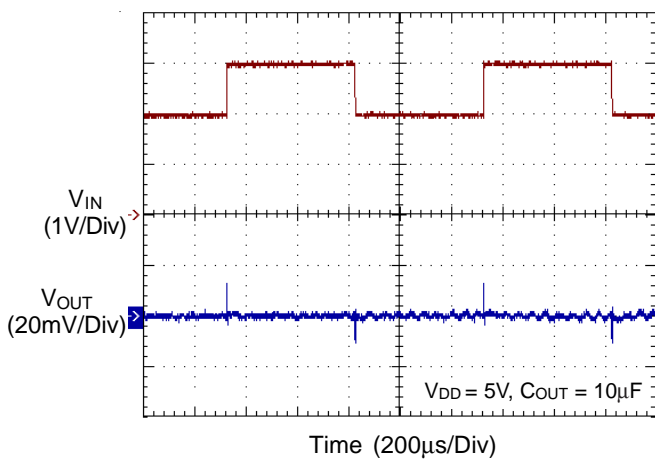

**V<sub>DD</sub> Line Transient Response**

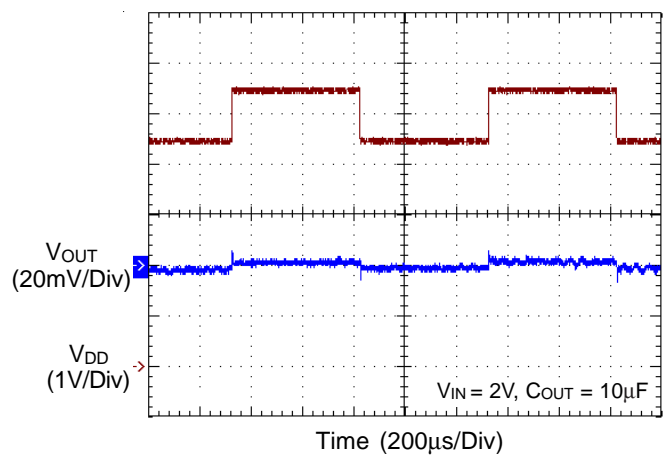

Start Up from V<sub>DD</sub>

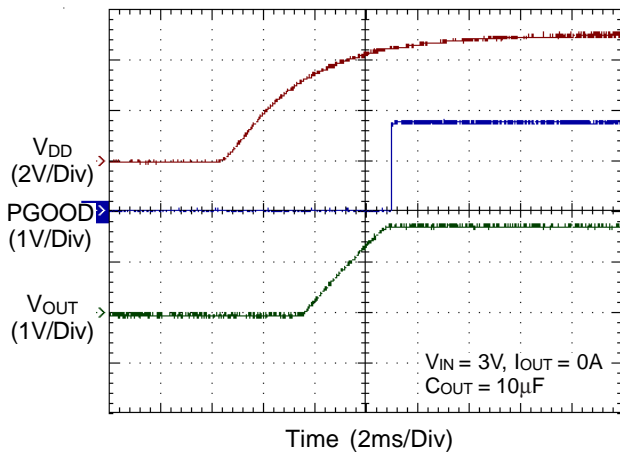

Start Up from V<sub>IN</sub>

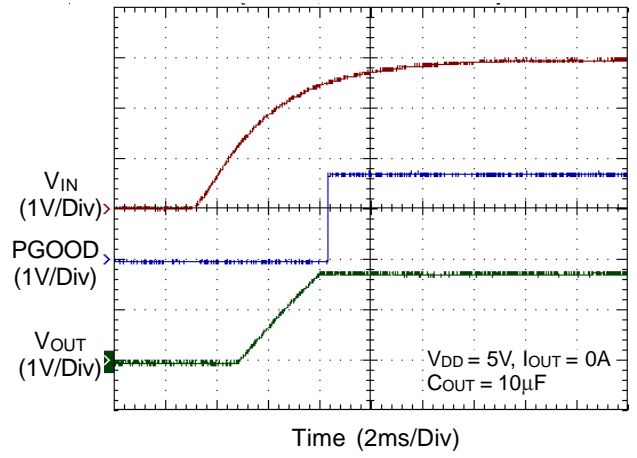

Start Up from Enable and PGOOD Delay

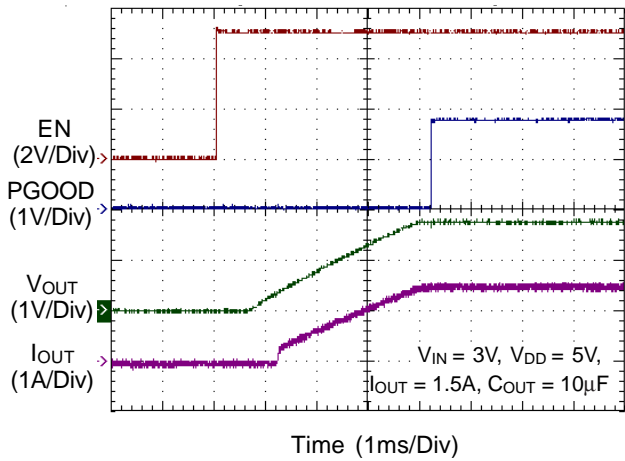



**Application Information**

*Richtek’s component specification does not include the following information in the Application Information section. Thereby no warranty is given regarding its validity and accuracy. Customers should take responsibility to verify their own designs and reserve suitable design margin to ensure the functional suitability of their components and systems.*

**Adjustable Mode Operation**

The output voltage of the RT9059 is adjustable from 0.8V to VIN by external voltage divider resistors as shown in Typical Application Circuit (Figure 1). The value of resistors R1 and R2 should be more than 10kΩ to reduce the power loss. The output voltage can be calculated by the following equation :

$$V_{OUT} = V_{REF} \times \left(1 + \frac{R1}{R2}\right)$$

where VREF is the reference voltage (0.8V typical).

**Enable**

The RT9059 goes into shutdown mode when the EN pin is in the logic low condition. During this condition, the pass transistor, error amplifier, and band gap are turned off, reducing the supply current to 1μA typical. The RT9059 goes into operation mode when the EN pin is in the logic high condition. If the EN pin is floating, please notice the RT9059 internal initial logic level. For the RT9059, the EN pin function pulls low level internally. So the regulator will be turned off when EN pin is floating.

**Input Capacitor**

Good bypassing is recommended from input to ground to improve AC performance. A 10μF input capacitor or greater located as close as possible to the IC is recommended.

**Output Capacitor**

The output capacitor must meet both requirements for minimum amount of capacitance and ESR in all LDO applications. The RT9059 is designed specifically to work with low ESR ceramic output capacitor in space-saving and performance consideration. Using a ceramic capacitor of which value is at least 10μF on the RT9059 output ensures stability. The RT9059 still works well with output capacitor of other types due to the wide stable ESR range. Output capacitor of larger capacitance can reduce noise and improve load transient response, stability, and PSRR.

The output capacitor should be located no more than 0.5 inch from the VOUT pin of the RT9059 and returned to a clean analog ground.

**Current Limit**

The RT9059 contains an independent current limit and the short circuit current protection to prevent unexpected applications. The current limit monitors and controls the pass transistor's gate voltage, minimum limiting the output current to 3.1A (typical). When the output voltage is less than 0.2V, the short circuit current protection starts the current fold back function and maintains the loading current at maximum 1.8A. The output can be shorted to ground indefinitely without damaging the part.

**Power Good**

The power good function is an open-drain output. Connect a 100kΩ pull up resistor to VOUT to obtain an output voltage. The PGOOD pin will output high immediately after the output voltage arrives 90% of normal output voltage.

**Thermal Shutdown Protection**

Thermal protection limits power dissipation to prevent IC over temperature in the RT9059. When the operation junction temperature exceeds 160°C, the over temperature protection circuit starts the thermal shutdown function and turns the pass transistor off. The pass transistor turns on again after the junction temperature cools by 70°C.

**Thermal Considerations**

For continuous operation, do not exceed absolute maximum junction temperature. The maximum power dissipation depends on the thermal resistance of the IC package, PCB layout, rate of surrounding airflow, and difference between junction and ambient temperature. The maximum power dissipation can be calculated by the following formula :

$$P_{D(MAX)} = (T_{J(MAX)} - T_A) / \theta_{JA}$$

where  $T_{J(MAX)}$  is the maximum junction temperature,  $T_A$  is the ambient temperature, and  $\theta_{JA}$  is the junction to ambient thermal resistance.

For recommended operating condition specifications, the maximum junction temperature is 125°C. The junction to ambient thermal resistance,  $\theta_{JA}$ , is layout dependent. For SOP-8 (Exposed Pad) package, the thermal resistance,  $\theta_{JA}$ , is 32.4°C/W on a standard JEDEC 51-7 four-layer thermal test board. For WDFN-10L 3x3 package, the thermal resistance,  $\theta_{JA}$ , is 32.8°C/W on a standard JEDEC 51-7 four-layer thermal test board. The maximum power dissipation at  $T_A = 25^\circ\text{C}$  can be calculated by the following formula :

$$P_{D(MAX)} = (125^\circ\text{C} - 25^\circ\text{C}) / (32.4^\circ\text{C/W}) = 3.08\text{W for SOP-8 (Exposed Pad) package}$$

$$P_{D(MAX)} = (125^\circ\text{C} - 25^\circ\text{C}) / (32.8^\circ\text{C/W}) = 3.04\text{W for WDFN-10L 3x3 package}$$

The maximum power dissipation depends on the operating ambient temperature for fixed  $T_{J(MAX)}$  and thermal resistance,  $\theta_{JA}$ . The derating curve in Figure 3 allows the designer to see the effect of rising ambient temperature on the maximum power dissipation.

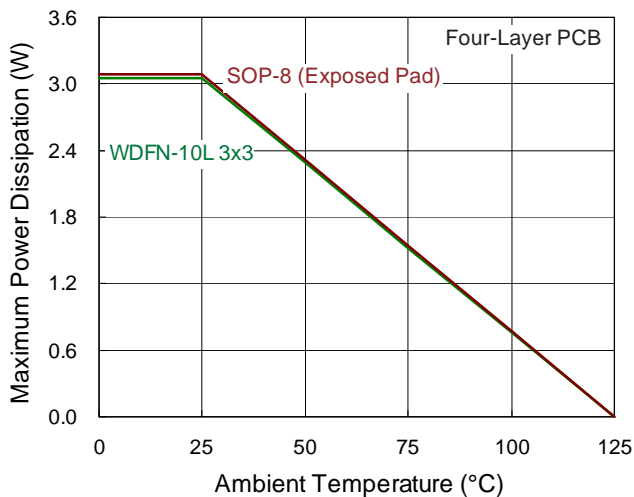
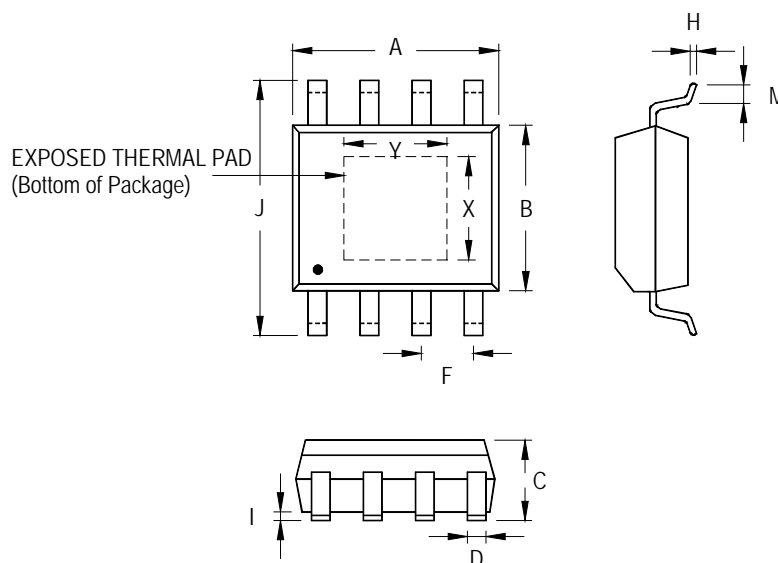

Figure 3. Derating Curve of Maximum Power Dissipation

**Outline Dimension**



Symbol	Dimensions In Millimeters		Dimensions In Inches		
	Min	Max	Min	Max	
A	4.801	5.004	0.189	0.197	
B	3.810	4.000	0.150	0.157	
C	1.346	1.753	0.053	0.069	
D	0.330	0.510	0.013	0.020	
F	1.194	1.346	0.047	0.053	
H	0.170	0.254	0.007	0.010	
I	0.000	0.152	0.000	0.006	
J	5.791	6.200	0.228	0.244	
M	0.406	1.270	0.016	0.050	
Option 1	X	2.000	2.300	0.079	0.091
	Y	2.000	2.300	0.079	0.091
Option 2	X	2.100	2.500	0.083	0.098
	Y	3.000	3.500	0.118	0.138

**8-Lead SOP (Exposed Pad) Plastic Package**

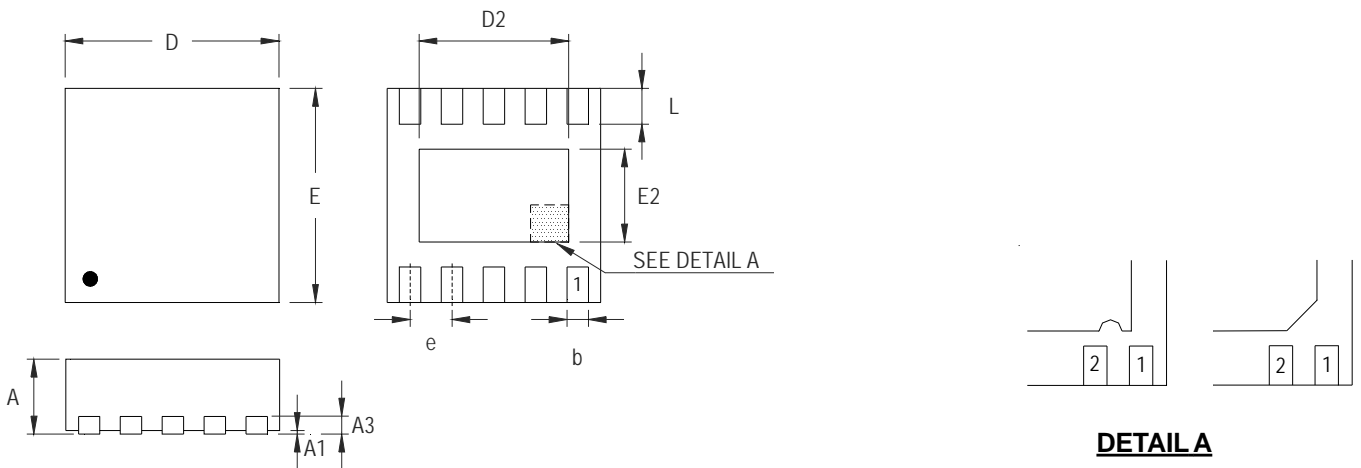

**DETAIL A**

Pin #1 ID and Tie Bar Mark Options

Note : The configuration of the Pin #1 identifier is optional, but must be located within the zone indicated.

Symbol	Dimensions In Millimeters		Dimensions In Inches	
	Min	Max	Min	Max
A	0.700	0.800	0.028	0.031
A1	0.000	0.050	0.000	0.002
A3	0.175	0.250	0.007	0.010
b	0.180	0.300	0.007	0.012
D	2.950	3.050	0.116	0.120
D2	2.300	2.650	0.091	0.104
E	2.950	3.050	0.116	0.120
E2	1.500	1.750	0.059	0.069
e	0.500		0.020	
L	0.350	0.450	0.014	0.018

**W-Type 10L DFN 3x3 Package**

**Packing Information**

**Tape and Reel Data (PSOP-8)**

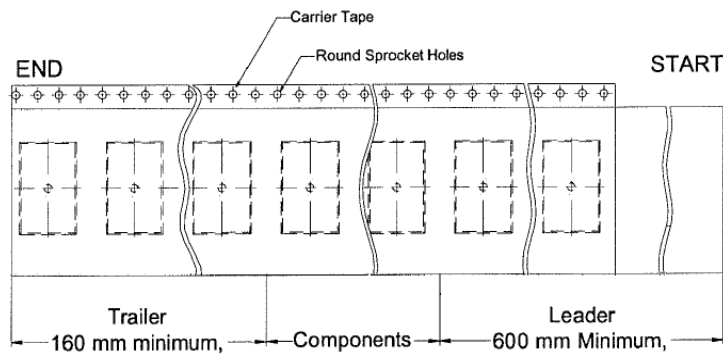
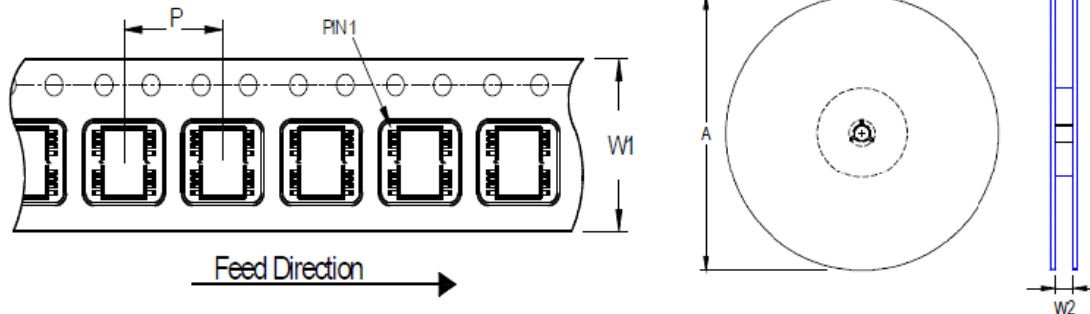

Package Type	Tape Size (W1) (mm)	Pocket Pitch (P) (mm)	Reel Size (A)		Units per Reel	Trailer (mm)	Leader (mm)	Reel Width (W2) Min./Max. (mm)
			(mm)	(in)				
PSOP-8	12	8	330	13	2,500	160	600	12.4/14.4

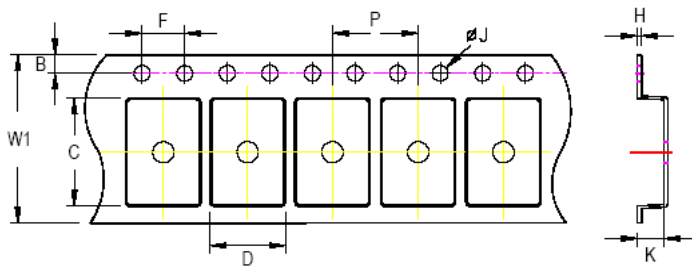

**C, D and K are determined by component size.**  
**The clearance between the components and the cavity is as follows:**  
 - For 12mm carrier tape: 0.5mm max.

Tape Size	W1	P		B		F		ØJ		H
	Max.	Min.	Max.	Min.	Max.	Min.	Max.	Min.	Max.	Max.
12mm	12.3mm	7.9mm	8.1mm	1.65mm	1.85mm	3.9mm	4.1mm	1.5mm	1.6mm	0.6mm

## Tape and Reel Data (QFN/DFN 3x3) (Units per Reel: 1500)

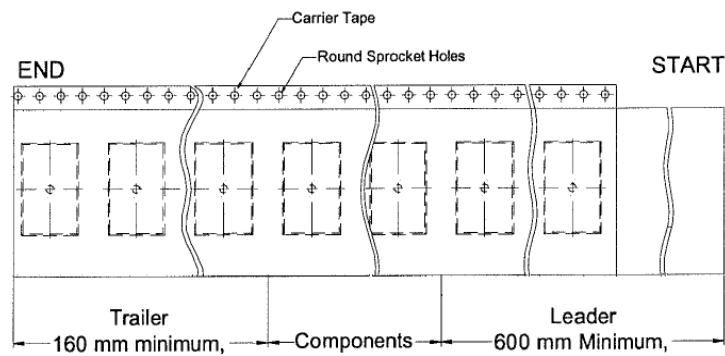
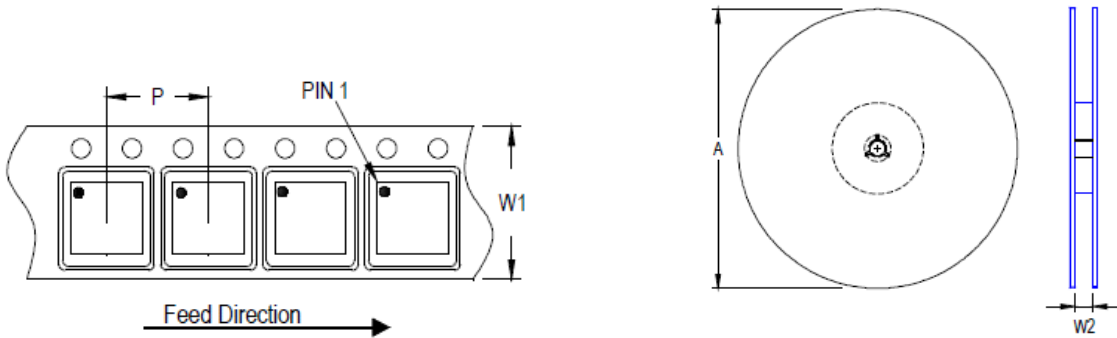

Package Type	Tape Size (W1) (mm)	Pocket Pitch (P) (mm)	Reel Size (A)		Units per Reel	Trailer (mm)	Leader (mm)	Reel Width (W2) Min./Max. (mm)
			(mm)	(in)				
QFN/DFN 3x3	12	8	180	7	1,500	160	600	12.4/14.4

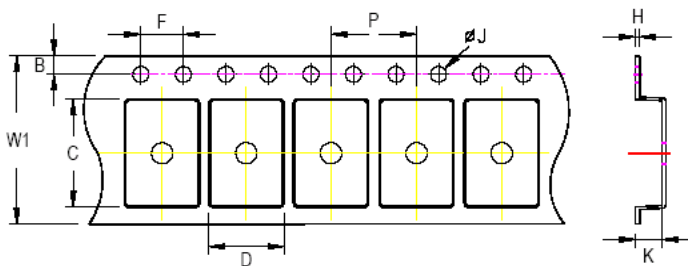

**C, D and K are determined by component size.**  
**The clearance between the components and the cavity is as follows:**  
 - For 12mm carrier tape: 0.5mm max.

Tape Size	W1		P		B		F		ØJ		H
	Max.	Min.	Max.	Min.	Max.	Min.	Max.	Min.	Max.	Max.	
12mm	12.3mm	7.9mm	8.1mm	1.65mm	1.85mm	3.9mm	4.1mm	1.5mm	1.6mm	0.6mm	

**Tape and Reel Data (QFN/DFN 3x3) (Units per Reel: 3000)**

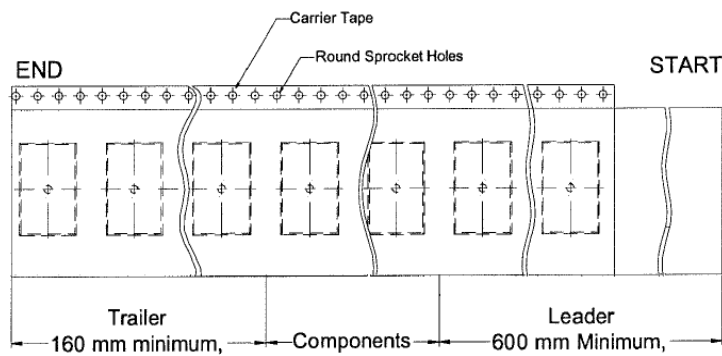
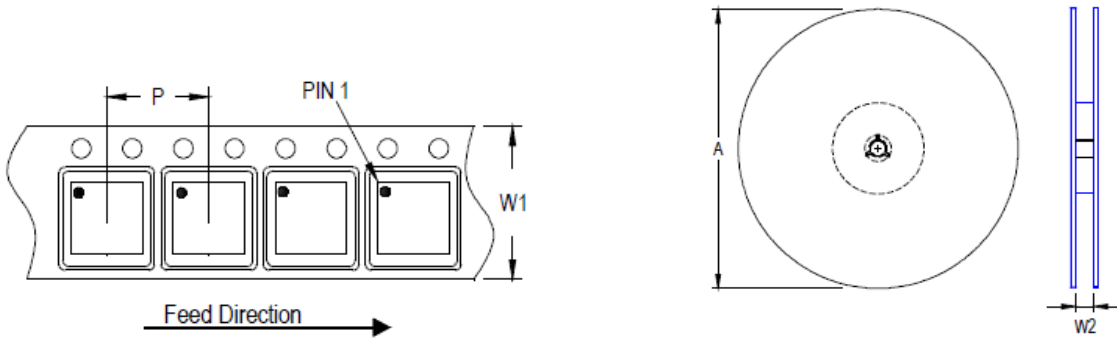

Package Type	Tape Size (W1) (mm)	Pocket Pitch (P) (mm)	Reel Size (A)		Units per Reel	Trailer (mm)	Leader (mm)	Reel Width (W2) Min./Max. (mm)
			(mm)	(in)				
QFN/DFN 3x3	8	4	180	7	3,000	160	600	8.4/9.9

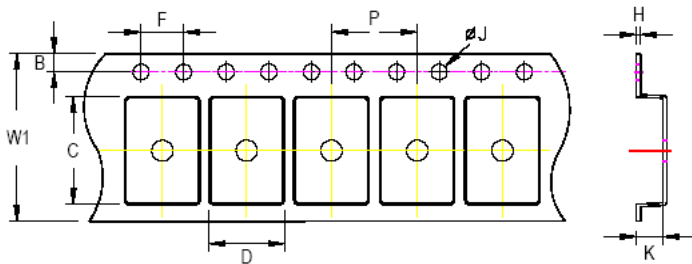







**C, D and K are determined by component size. The clearance between the components and the cavity is as follows:**

- For 12mm carrier tape: 0.5mm max.

Tape Size	W1		P		B		F		ØJ		H
	Max.	Min.	Max.	Min.	Max.	Min.	Max.	Min.	Max.	Max.	
8mm	8.3mm	3.9mm	4.1mm	1.65mm	1.85mm	3.9mm	4.1mm	1.5mm	1.6mm	0.6mm	







Tape and Reel Packing (PSOP-8)

Step	Photo/Description	Step	Photo/Description
1	 <p>Reel 13"</p>	4	 <p>1 reel per inner box <b>Box G</b></p>
2	 <p>HIC &amp; Desiccant (2 Unit) inside</p>	5	 <p>6 inner boxes per outer box</p>
3	 <p>Caution label is on backside of Al bag</p>	6	 <p>Outer box <b>Carton A</b></p>

Package	Container		Reel			Box			Carton		
	Size	Units	Item	Reels	Units	Item	Boxes	Units			
PSOP-8	13"	2,500	Box G	1	2,500	Carton A	6	15,000			









**Tape and Reel Packing (QFN/DFN 3x3) (Units per Reel: 1500)**

Step	Photo/Description	Step	Photo/Description
1	 Reel 7"	4	 3 reels per inner box <b>Box A</b>
2	 HIC & Desiccant (1 Unit) inside	5	 12 inner boxes per outer box
3	 Caution label is on backside of AI bag	6	 Outer box <b>Carton A</b>

Package	Reel		Box				Carton			
	Size	Units	Item	Size(cm)	Reels	Units	Item	Size(cm)	Boxes	Unit
QFN & DFN 3x3	7"	1,500	Box A	18.3*18.3*8.0	3	4,500	Carton A	38.3*27.2*38.3	12	54,000
			Box E	18.6*18.6*3.5	1	1,500	For Combined or Partial Reel.			

### Tape and Reel Packing (QFN/DFN 3x3) (Units per Reel: 3000)

Step	Photo/Description	Step	Photo/Description
1	 <p>Reel 7"</p>	4	 <p>3 reels per inner box <b>Box A</b></p>
2	 <p>HIC &amp; Desiccant (1 Unit) inside</p>	5	 <p>12 inner boxes per outer box</p>
3	 <p>Caution label is on backside of AI bag</p>	6	 <p>Outer box <b>Carton A</b></p>

Container Package	Reel		Box				Carton			
	Size	Units	Item	Size(cm)	Reels	Units	Item	Size(cm)	Boxes	Unit
QFN & DFN 3x3	7"	3,000	Box A	18.3*18.3*8.0	3	9,000	Carton A	38.3*27.2*38.3	12	108,000
			Box E	18.6*18.6*3.5	1	3,000	For Combined or Partial Reel.			

**Packing Material Anti-ESD Property**

Surface Resistance	Aluminum Bag	Reel	Cover tape	Carrier tape	Tube	Protection Band
$\Omega/\text{cm}^2$	$10^4$ to $10^{11}$	$10^4$ to $10^{11}$	$10^4$ to $10^{11}$	$10^4$ to $10^{11}$	$10^4$ to $10^{11}$	$10^4$ to $10^{11}$

**Richtek Technology Corporation**

14F, No. 8, Tai Yuen 1<sup>st</sup> Street, Chupei City  
 Hsinchu, Taiwan, R.O.C.  
 Tel: (8863)5526789

**RICHTEK**

Richtek products are sold by description only. Richtek reserves the right to change the circuitry and/or specifications without notice at any time. Customers should obtain the latest relevant information and data sheets before placing orders and should verify that such information is current and complete. Richtek cannot assume responsibility for use of any circuitry other than circuitry entirely embodied in a Richtek product. Information furnished by Richtek is believed to be accurate and reliable. However, no responsibility is assumed by Richtek or its subsidiaries for its use; nor for any infringements of patents or other rights of third parties which may result from its use. No license is granted by implication or otherwise under any patent or patent rights of Richtek or its subsidiaries.

## Datasheet Revision History

Version	Date	Description	Item
12	2023/5/29	Modify	Ordering and Marking Information on P2 Electrical Characteristics on P6 Typical Operating Characteristics on P8 Packing Information on P14, 15, 16, 17, 18