

Linear Single Cell Li-Ion Battery Charger with Auto Power Path

General Description

The RT9525 is an integrated single cell Li-ion battery charger with Auto Power Path Management (APPM). No external MOSFETs are required. The RT9525 enters sleep mode when power is removed. Charging tasks are optimized by using a control algorithm to vary the charge rate including pre-charge mode, fast charge mode and constant voltage mode. For the RT9525, the charge current can also be programmed with an external resistor. Additionally, the internal thermal feedback circuitry regulates the die temperature to optimize the charge rate for all ambient temperatures. The charging task will always be terminated in constant voltage mode when the charging current reduces to the termination current of 20% I_{CHG_FAST} . Other features include under voltage protection and over voltage protection for the VIN supply.

Ordering Information

RT9525□□

- Package Type
QW : WQFN-16L 3x3 (W-Type)
- Lead Plating System
G : Green (Halogen Free and Pb Free)

Note :

Richtek products are :

- ▶ RoHS compliant and compatible with the current requirements of IPC/JEDEC J-STD-020.
- ▶ Suitable for use in SnPb or Pb-free soldering processes.

Marking Information

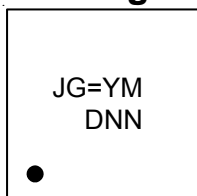

JG = : Product Code
YMDNN : Date Code

Features

- 28V Maximum Rating for VIN Power
- Selectable Power Current Limit (0.1A / 0.5A / 1.5A)
- Integrated Power MOSFETs
- Auto Power Path Management (APPM)
- Programmable Charging Current Timer and Safe Charge Timer
- Under Voltage Protection
- Over Voltage Protection
- Power Good and Charger Status Indicator
- Optimized Charge Rate via Thermal Feedback
- 16-Lead WQFN Package
- RoHS Compliant and Halogen Free

Applications

- Digital Cameras
- PDAs and Smart Phones
- Portable Instruments

Pin Configurations

(TOP VIEW)

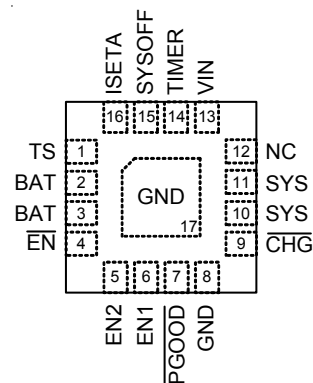

WQFN-16L 3x3

Typical Application Circuit

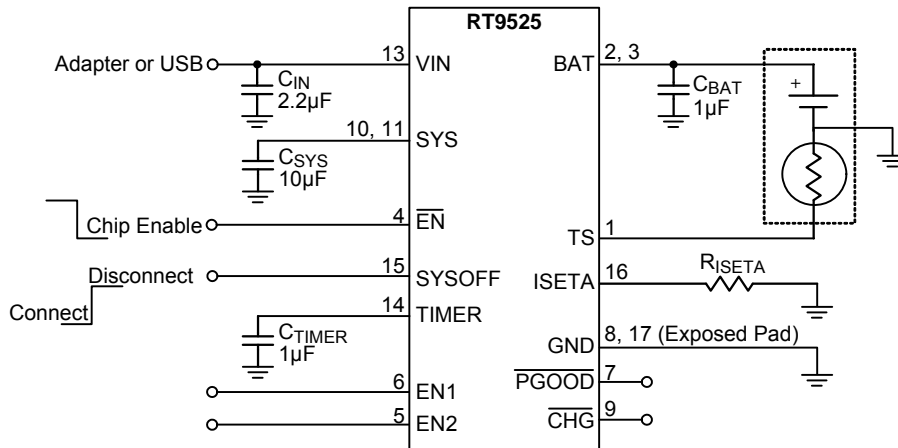

Functional Pin Description

Pin No.	Pin Name	Pin Function
1	TS	Thermistor Monitor Input. The TS pin connects to a battery's thermistor to determine if the battery is too hot or too cold to charge. If the battery's temperature is out of range, charging is paused until it re-enters the valid range. TS also detect whether the battery (with NTC) is present or not
2, 3	BAT	Battery Connect Pin.
4	EN	Charge Enable, Active-low input. 200kΩ pull low.
5	EN2	Input Current Limit Configuration Setting.
6	EN1	
7	PGOOD	Power Good Status Output. Active-low, open-drain output.
8, 17 (Exposed Pad)	GND	Ground. The exposed pad must be soldered to a large PCB and connected to GND for maximum power dissipation.
9	CHG	Charger Status Output. Active-low, open-drain output.
10, 11	SYS	System Connect Pin. Connect this pin to system load with a minimum 10uF MLCC to GND.
12	NC	No Internal Connection.
13	VIN	Supply Voltage Input.
14	TIMER	Safe Charge Timer Setting.
15	SYSOFF	System Disconnect Pin. Pull SYSOFF high to disconnect SYS from battery, connect to GND for normal operation. Internally pulled up by 1µA current source to BAT.
16	ISETA	Charge Current Set Input. Connect a resistor (RISETA) between ISET and GND.

Function Block Diagram

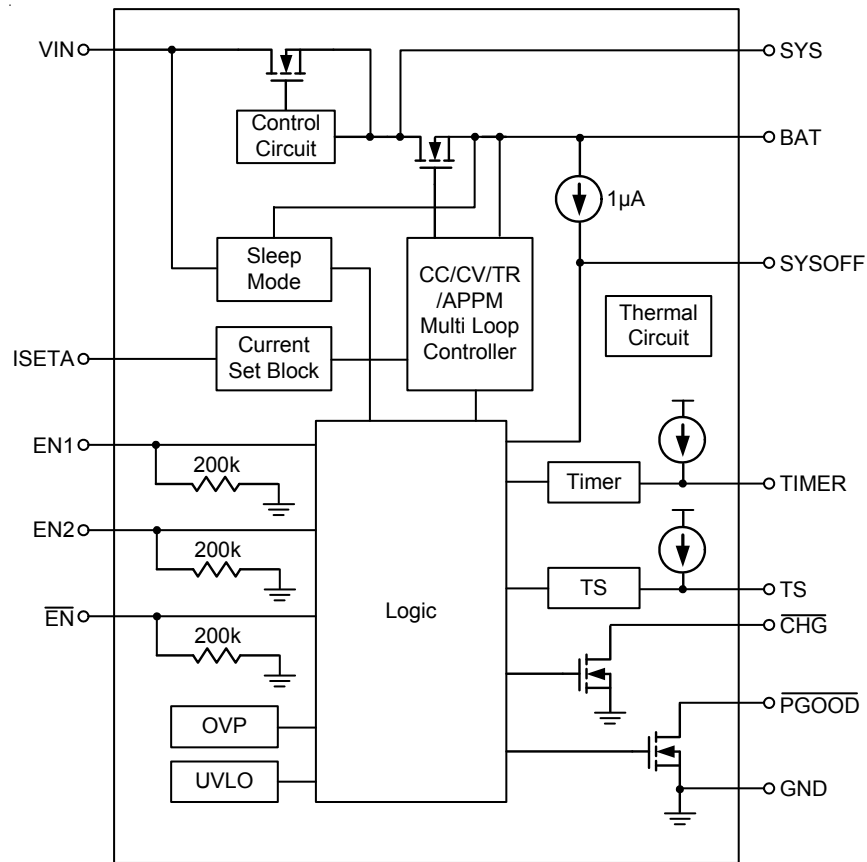

Absolute Maximum Ratings (Note 1)

• Supply Input Voltage, V_{IN} -----	-0.3V to 28V
• \overline{CHG} , \overline{PGOOD} -----	-0.3V to 28V
• Other Pins-----	-0.3V to 6V
• \overline{CHG} , \overline{PGOOD} Continuous Current-----	20mA
• BAT Continuous Current (total in two pins) (Note 2)-----	2.5A
• Power Dissipation, P_D @ $T_A = 25^\circ\text{C}$	
WQFN-16L 3x3-----	1.471W
• Package Thermal Resistance (Note 3)	
WQFN-16L 3x3, θ_{JA} -----	68°C/W
WQFN-16L 3x3, θ_{JC} -----	7.5°C/W
• Lead Temperature (Soldering, 10 sec.)-----	260°C
• Junction Temperature-----	150°C
• Storage Temperature Range-----	-65°C to 150°C
• ESD Susceptibility (Note 4)	
HBM (Human Body Model)-----	2kV
MM (Machine Model)-----	200V

Recommended Operating Conditions (Note 5)

• Supply Input Voltage, V_{IN} (EN2 = H, EN1 = L)-----	4.45V to 6V
• Supply Input Voltage, V_{IN} (EN2 = L, EN1 = X)-----	4.65V to 6V
• Junction Temperature Range-----	-40°C to 125°C
• Ambient Temperature Range-----	-40°C to 85°C

Electrical Characteristics

($V_{IN} = 5V$, $V_{BAT} = 4V$, $T_A = 25^\circ\text{C}$, unless otherwise specification)

Parameter	Symbol	Test Conditions	Min	Typ	Max	Unit
Supply Input						
VIN Operating Range			4.2	--	6	V
VIN Under Voltage Lockout Threshold	V_{UVLO}		3.1	3.3	3.5	V
VIN Under Voltage Lockout Hysteresis	V_{UVLO_hys}		--	240	--	mV
VIN Supply Current	I_{IN}	$I_{SYS} = I_{BAT} = 0\text{mA}$, $\overline{EN} = L$	--	1	2	mA
		$I_{SYS} = I_{BAT} = 0\text{mA}$, $\overline{EN} = H$	--	0.8	1.5	
VIN Suspend Current	I_{SUS}	$V_{IN} = 5V$, EN2 = EN1 = H	--	195	333	μA
BAT Sleep Leakage Current	I_{SLEEP}	$V_{BAT} > V_{IN}$, ($V_{IN} = 0V$)	--	5	15	μA
VIN – BAT VOS Rising	V_{OS_H}		--	200	300	mV
VIN – BAT VOS Falling	V_{OS_L}		10	50	--	mV
Voltage Regulation						
Battery Regulation Voltage	V_{REG}	0 to 85°C, $I_{LOAD} = 20\text{mA}$	4.16	4.2	4.23	V
System Regulation Voltage	V_{SYS}	$V_{IN} = 6V$	5.3	5.5	5.7	V
APPM Regulation Voltage	V_{APPM}	EN2 = L, EN1 = H	4.2	4.3	4.4	V
DPM Regulation Voltage	V_{DPM}	EN2 = L	4.35	4.5	4.63	V
VIN to VSYS MOSFET Ron	$R_{DS(ON)}$	$I_{LIM} = 1000\text{mA}$	--	0.2	0.35	Ω

Parameter	Symbol	Test Conditions	Min	Typ	Max	Unit
BAT to VSYS MOSFET Ron	R _{DS(ON)}	V _{BAT} = 4.2V, I _{SYN} = 1A	--	0.05	0.1	Ω
Re-charge threshold	ΔV _{REGCGG}	Battery Regulation – Recharge-level	120	200	280	mV
Current Regulation						
ISETA Set Voltage (Fast Charge Phase)	V _{ISETA}	V _{BATT} = 4V, R _{ISETA} = 1kΩ	--	2	--	V
VIN Charge Setting Range	I _{CHG}		100	--	1200	mA
VIN Charge Current	I _{CHG}	V _{BATT} = 4V, R _{ISETA} = 1kΩ	570	600	630	mA
VIN Current Limit	I _{LIM}	EN2 = H, EN1 = L (1.5A mode)	1.2	1.5	1.8	A
		EN2 = L, EN1 = H (500mA mode)	450	475	500	mA
		EN2 = L, EN1 = L (100mA mode)	80	90	100	mA
Pre-Charge						
BAT Pre-Charge Threshold	V _{PRECH}	BAT Falling	2.75	2.85	2.95	V
BAT Pre-Charge Threshold Hysteresis	ΔV _{PRECH}		--	200	--	mV
Pre-Charge Current	I _{PRECH}	V _{BAT} = 2V	5	10	15	%
Charge Termination Detection						
Termination Current Ratio to Fast Charge	I _{TERM}		10	20	30	%
Termination Current Ratio to Fast Charge USB100mA	I _{TERM2}	EN2 = L, EN1 = L	--	3.3	--	%
Login Input/Output						
CHG Pull Down Voltage	V _{CHG}	I _{CHG} = 5mA	--	200	--	mV
PGOOD Pull Down Voltage	V _{PGOOD}	I _{PGOOD} = 5mA	--	200	--	mV
EN, EN1, EN2, SYSOFF Pin Threshold	V _{IH}		1.5	--	-	V
	V _{IL}		--	--	0.4	
Protection						
Thermal Regulation	T _{REG}		--	125	--	°C
Thermal Shutdown Temperature	T _{SD}		--	155	--	°C
Thermal Shutdown Hysteresis	ΔT _{SD}		--	20	--	°C
OVP SET Voltage	V _{OVP}	V _{IN} Rising	6.25	6.5	6.75	V
OVP Hysteresis	V _{OVP_hys}		--	100	--	mV
Output Short Circuit Detection Threshold	V _{SHORT}	V _{BAT} – V _{SYN}	--	300	--	mV
Time						
Pre-Charge Fault Time	t _{PCHG}	C _{TIMER} = 1μF (1/8 x t _{FCHG})	1440	1800	2160	s
Fast charge Fault Time	t _{FCHG}	C _{TIMER} = 1μF	11520	14400	17280	s
PGOOD Deglitch Time	t _{PGOOD}	Time measured from V _{IN} : 0→5V 1μs rise-time to PGOOD = L	--	1.2	--	ms
Input Over Voltage Blanking Time	t _{OVP}		--	50	--	μs

Parameter	Symbol	Test Conditions	Min	Typ	Max	Unit
Pre-Charge to Fast-Charge Deglitch Time	t _{PF}		--	25	--	ms
Fast-Charge to Pr-Charger Deglitch Time	t _{fp}		--	25	--	ms
Termination Deglitch Time	t _{TERMI}		--	25	--	ms
Recharge Deglitch Time	t _{RECHG}		--	100	--	ms
Input Power Loss to SYS LDO Turn-Off Delay Time	t _{NO-IN}		--	25	--	ms
Packing Temperature Fault Detection Deglitch Time	t _{TS}		--	25	--	ms
Short Circuit, Deglitch Time	t _{SHORT}		--	250	--	μs
Short Circuit Recovery Time	t _{SHORT_R}			64	--	ms
Other						
NTC Bias Current	I _{NTC}	V _{IN} > UVLO and V _{IN} > V _{BAT} + V _{OS_H}	72	75	78	μA
High Temperature Trip Point	V _{HOT}	V _{TS} Falling	270	300	330	mV
High Temperature Trip Point Hysteresis	V _{HOT_hys}	V _{TS} Rising from V _{HOT}	--	30	--	mV
Low Temperature Trip Point	V _{COLD}	V _{TS} Rising	2000	2100	2200	mV
Low Temperature Trip Point Hysteresis	V _{COLD_hys}	V _{TS} Falling from V _{COLD}	--	300	--	mV

Note 1. Stresses beyond those listed “Absolute Maximum Ratings” may cause permanent damage to the device. These are stress ratings only, and functional operation of the device at these or any other conditions beyond those indicated in the operational sections of the specifications is not implied. Exposure to absolute maximum rating conditions may affect device reliability.

Note 2. Guaranteed by design.

Note 3. θ_{JA} is measured at T_A = 25°C on a high effective thermal conductivity four-layer test board per JEDEC 51-7. θ_{JC} is measured at the exposed pad of the package.

Note 4. Devices are ESD sensitive. Handling precaution is recommended.

Note 5. The device is not guaranteed to function outside its operating conditions.

Typical Operating Characteristics

Charger Detect Sequence

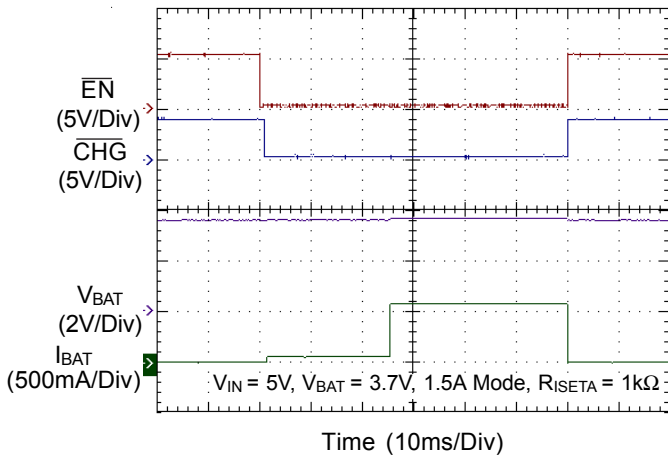

SYSOFF On/Off Without Input Power

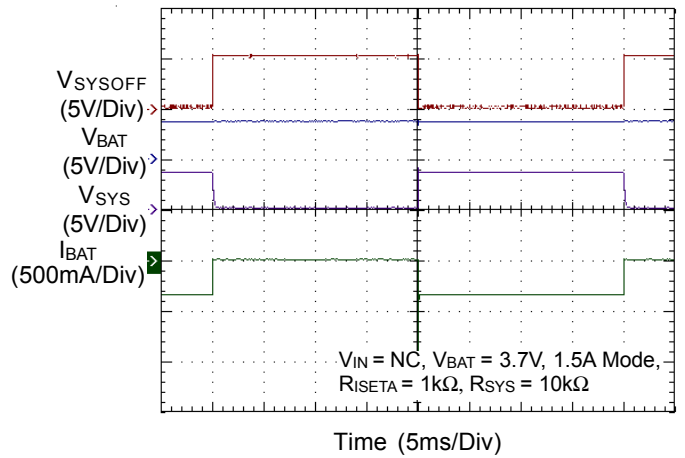

SYSOFF On/Off With Input Power

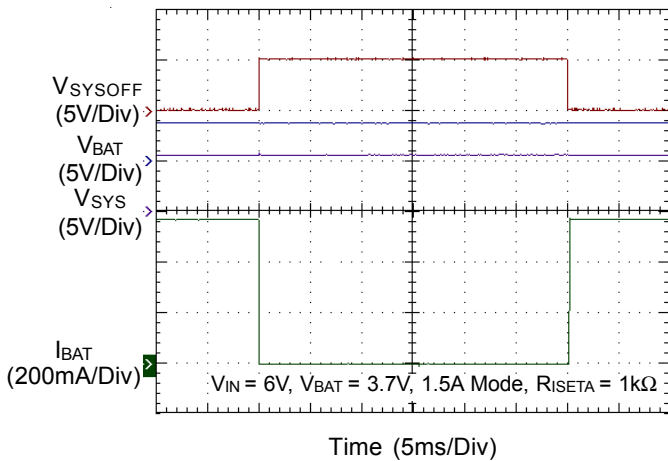

OVP Fault

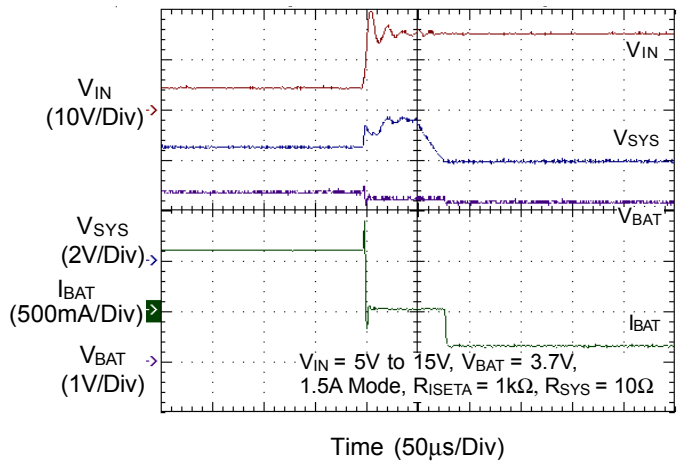

Load Transient Response

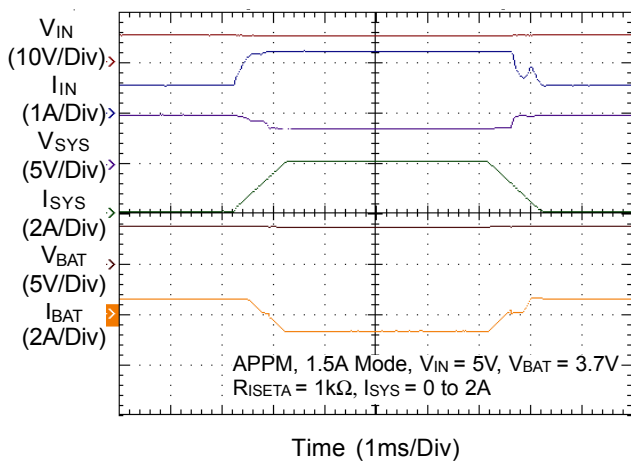

Charger CHG Status After Safety Timers Expired

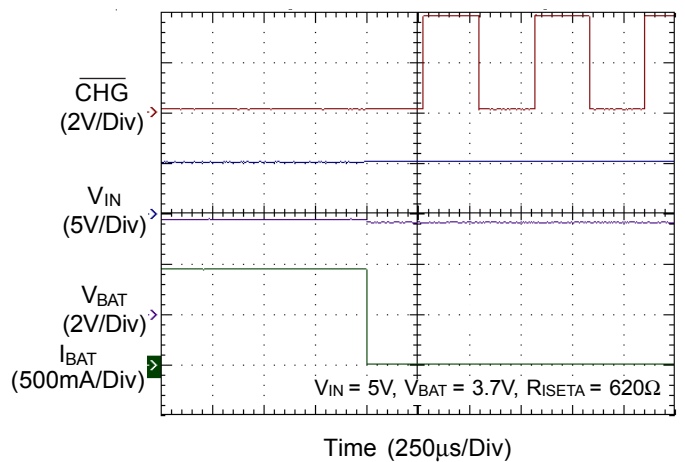

V_{sys} Short to GND Protection with Battery

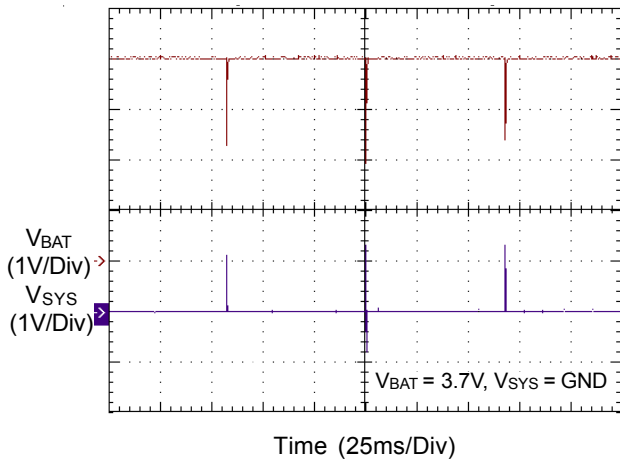

Battery Current vs. Charging Time

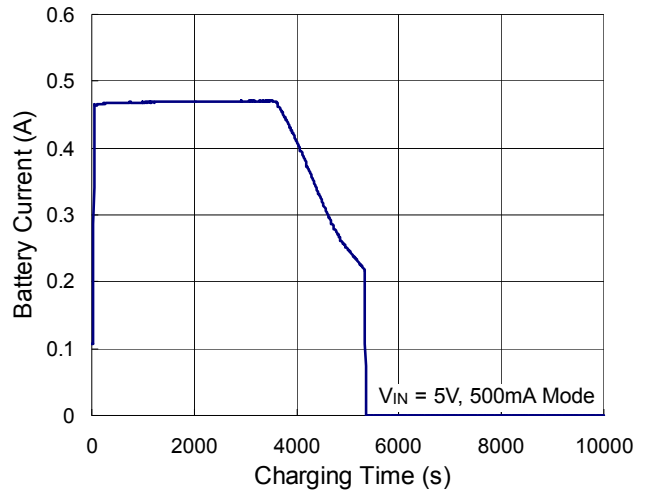

Battery Voltage vs. Charging Time

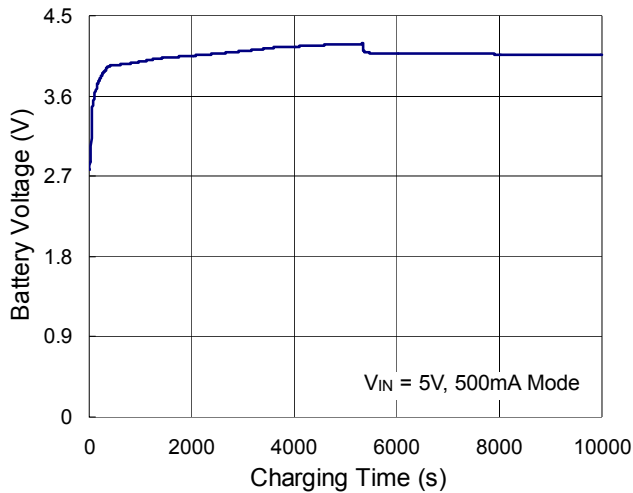

Charging Current vs. Battery Voltage

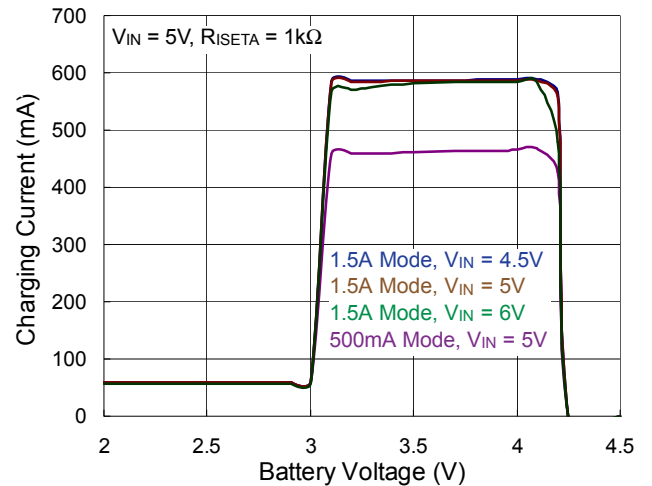

Charging Current vs. R_{ISETA}

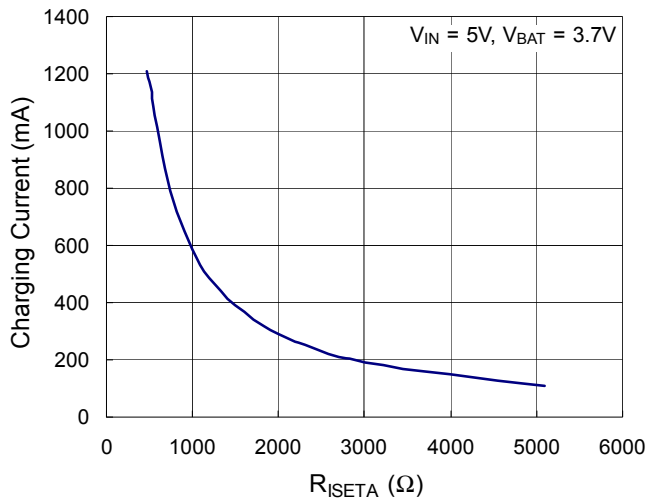

Output Regulation Voltage vs. Temperature

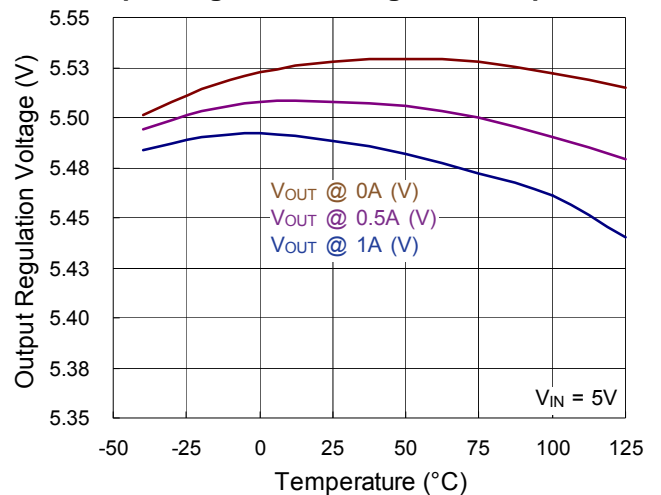

OVP Threshold Voltage vs. Temperature

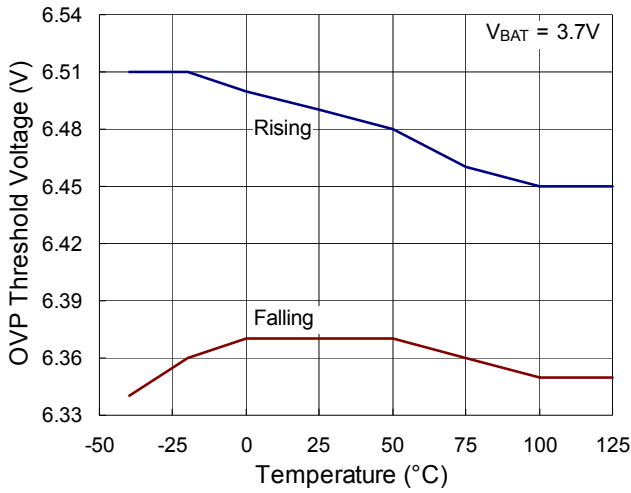

Dropout Voltage (In-Out) vs. Temperature

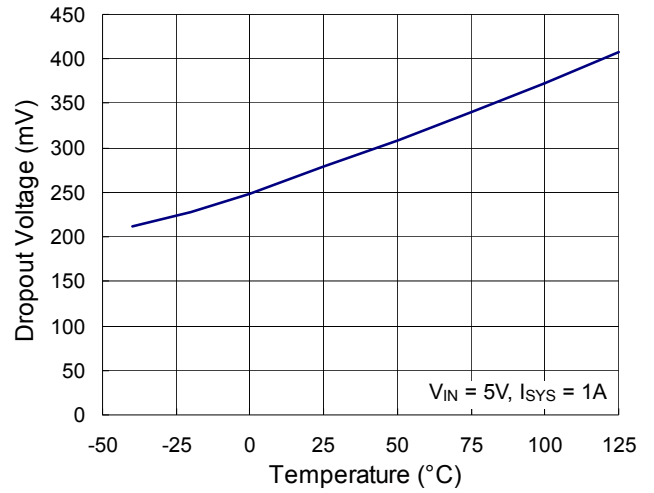

Dropout Voltage (Bat-Out) vs. Temperature

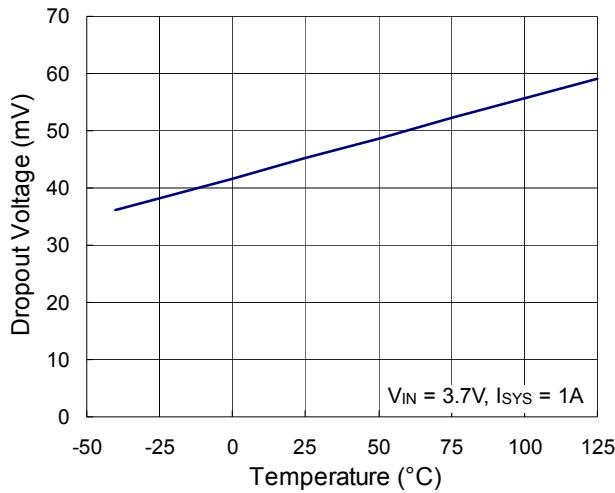

Charger Current vs. Temperature

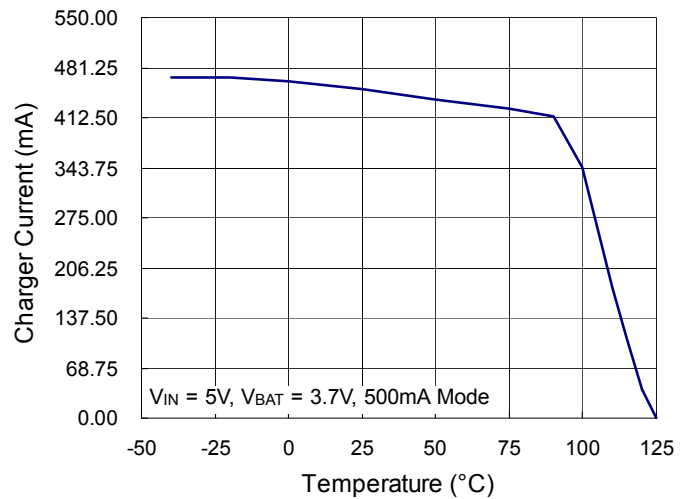

Application Information

The RT9525 is a fully integrated single cell Li-ion battery charger ideal for portable applications. The internal thermal feedback circuitry regulates the die temperature to optimize the charge rate for all ambient temperatures. Other features include under voltage protection and over voltage protection.

Pre-Charge Mode

When the output voltage is lower than 2.8V, the charging current will be reduced to a fast charge current ratio set by R_{ISETA} to protect the battery life time.

Fast Charge Mode

When the output voltage is higher than 3V, the charging current will be equal to the fast charge current set by R_{ISETA} .

Constant Voltage Mode

When the output voltage is near 4.2V and the charging current falls below the termination current, after a deglitch time check of 25ms, the charger will become disabled and \overline{CHG} will go from L to H.

Re-Charge Mode

When the chip is in charge termination mode, the charging current will gradually go down to zero. However, once the voltage of the battery drops to below 4V, there will be a deglitch time of 100ms, and then the charging current will resume again.

Charging Current Decision

The charge current can be set according to the following equations :

$$I_{CHG_FAST} = V_{ISETA} / R_{ISETA} \times 300 \quad (A)$$

$$I_{CHG_PRE} = 10\% \times I_{CHG_FAST} \quad (A)$$

where V_{ISETA} unit = V; R_{ISETA} unit = Ω

Time Fault

The Fast Charge Fault Time can be set according to the following equations :

$$\text{Fast Charge Fault Time} : t_{FCHG} = 14400 \times C_{TIMER} \quad (s)$$

$$\text{Pre-Charge Fault Time} : t_{PCHG} = 1/8 \times t_{FCHG} \quad (s)$$

where C_{TIMER} unit is μF .

During the fast charge phase, several events may increase the timer duration.

For example, the system load current may have activated the APPM loop which reduces the available charging current, the device has entered thermal regulation because the IC junction temperature has exceeded T_{REG} .

During each of these events, if $3V < V_{BAT} < 4V$, the internal timers are slowed down proportionately to the reduction in charging current. However, once the duration exceeds the fault time, the \overline{CHG} output will flash at approximately 2Hz to indicate a fault condition and a charger current $\sim 1mA$.

$$t_{FCHG_true} = t_{FCHG} \times \frac{2}{V_{ISETA}}$$

t_{FCHG_true} : modified timer in fast charge

t_{FCHG} : original timer in fast charge

$$t_{FCHG} = 14400 \text{ sec} \times \left(\frac{C_{TIMER}}{1\mu F} \right)$$

$$t_{PCHG} = \frac{t_{FCHG}}{8}$$

t_{PCHG} : timer in pre-charge

Time fault release :

- (1) Re-plug power
- (2) Toggle /EN
- (3) Enter/Exit USB suspend mode
- (4) Removes Battery
- (5) OVP

Note that the fast charge fault time is independent of the charge current.

Power Good

VIN Power Good ($\overline{PGOOD} = L$)

Input State	\overline{PGOOD} Output
$V_{IN} < V_{UVLO}$	High impedance
$V_{UVLO} < V_{IN} < V_{BAT} + V_{OS_H}$	High impedance
$V_{BAT} + V_{OS_H} < V_{IN} < V_{OVP}$	Low impedance
$V_{IN} > V_{OVP}$	High impedance

Charge State Indicator

Charge State	CHG Output
Charging	Low (for first charge cycle)
Charging suspended by thermal loop	
Safety timers expired	2Hz flash
Charging done	High impedance
Recharging after termination	
IC disabled or no valid input power	

Battery Pack Temperature Monitoring

The RT9525 features an external battery pack temperature monitoring input. The TS input connects to the NTC thermistor in the battery pack to monitor battery temperature and prevent dangerous over temperature conditions. If at any time the voltage at TS falls outside of the operating range, charging will be suspended. The timers maintain their values but suspend counting. When charging is suspended due to a battery pack temperature fault, the CHG pin remains low and continues to indicate charging.

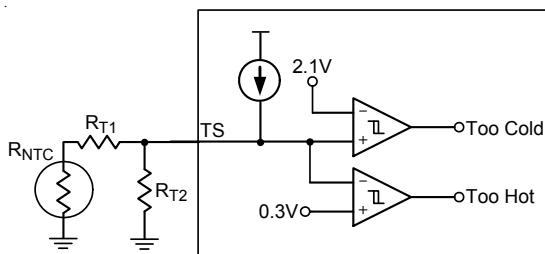

Figure 1

When temperature reaches at "Too Cold" state,

$$R_{NTC} = R_{COLD}$$

$$\frac{(R_{T1} + R_{COLD}) \times R_{T2}}{(R_{T1} + R_{COLD}) + R_{T2}} \times I_{NTC} = 2.1V \quad (V) \quad (1)$$

where $I_{NTC} = 75\mu A$ (typ.)

When temperature reaches at "Too Hot" state,

$$R_{NTC} = R_{HOT}$$

$$\frac{(R_{T1} + R_{HOT}) \times R_{T2}}{(R_{T1} + R_{HOT}) + R_{T2}} \times I_{NTC} = 0.3V \quad (V) \quad (2)$$

From (1), (2), the R_{T1} and R_{T2} can be calculated by the following equations :

$$R_{T1} = \frac{-1500\mu \times (R_{HOT} + R_{COLD})}{3000\mu} + \frac{20\sqrt{5625\mu^2 \times (R_{COLD} - R_{HOT})^2 + 105\mu \times (R_{COLD} - R_{HOT})}}{3000\mu}$$

$$R_{T2} = \frac{(R_{T1} + R_{HOT})}{250\mu \times R_{T1} + 250\mu \times R_{HOT} - 1}$$

Charge Enable

When \overline{EN} is low, the charger turns on. When \overline{EN} is high, the charger turn off. \overline{EN} is pulled low for initial condition.

VIN Input Current Limit

EN2	EN1	VIN Input Current Limit
L	L	90mA
L	H	475mA
H	L	1.5A
H	H	Suspend Mode

Suspend Mode

Set $EN1 = EN2 = H$, and the charger will enter Suspend Mode. In Suspend Mode, CHG is in high impedance and $I_{SUS(MAX)} < 330\mu A$.

Power Switch

For the RT9525, there are three power scenarios :

- (1) When a battery and an external power supply (USB or adapter) are connected simultaneously :
If the system load requirements exceed that of the input current limit, the battery will be used to supplement the current to the load. However, if the system load requirements are less than that of the input current limit, the excess power from the external power supply will be used to charge the battery.
- (2) When only the battery is connected to the system :
The battery provides the power to the system.
- (3) When only an external power supply is connected to the system :
The external power supply provides the power to the system.

Input DPM Mode

For the RT9525, the input voltage is monitored when the USB100 or USB500 is selected. If the input voltage is lower than V_{DPM} , the input current limit will be reduced to stop the input voltage from dropping any further. This can prevent the IC from damaging improperly configured or inadequately designed USB sources.

APPM Mode

Once the sum of the charging and system load currents becomes higher than the maximum input current limit, the SYS pin voltage will be reduced. When the SYS pin voltage is reduced to V_{APPM} , the RT9525 will automatically operate in APPM mode. In this mode, the charging current is reduced while the SYS current is increased to maintain system output. In APPM mode, the battery termination function is disabled.

Battery Supplement Mode Short Circuit Protect

In APPM mode, the SYS voltage will continue to drop if the charge current is zero and the system load increases beyond the input current limit. When the SYS voltage decreases below the battery voltage, the battery will kick in to supplement the system load until the SYS voltage rises above the battery voltage.

While in supplement mode, there is no battery supplement current regulation. However, a built in short circuit protection feature is available to prevent any abnormal current situations. While the battery is supplementing the load, if the difference between the battery and SYS voltage becomes more than the short circuit threshold voltage, SYS will be disabled. After a short circuit recovery time, t_{SHORT_R} , the counter will be restarted. In supplement mode, the battery termination function is disabled. Note that for the battery supply mode exit condition, $V_{BAT} - V_{SYS} < 0V$.

Battery Disconnect (SYSOFF input)

The RT9525 features a SYSOFF input that allows the user to turn off the switch to disconnect the battery from the SYS pin.

Thermal Regulation and Thermal Shutdown

The RT9525 provides a thermal regulation loop function to monitor the device temperature. If the die temperature rises above the regulation temperature, T_{REG} , the charge current will automatically be reduced to lower the die temperature. However, in certain circumstances (such as high V_{IN} , heavy system load, etc.) even with the thermal loop in place, the die temperature may still continue to increase. In this case, if the temperature rises above the thermal shutdown threshold, T_{SD} , the internal switch between V_{IN} and SYS will be turned off. The switch between the battery and SYS will remain on, however, to allow continuous battery power to the load. Once the die temperature decreases by ΔT_{SD} , the internal switch between V_{IN} and SYS will be turned on again and the device returns to normal thermal regulation.

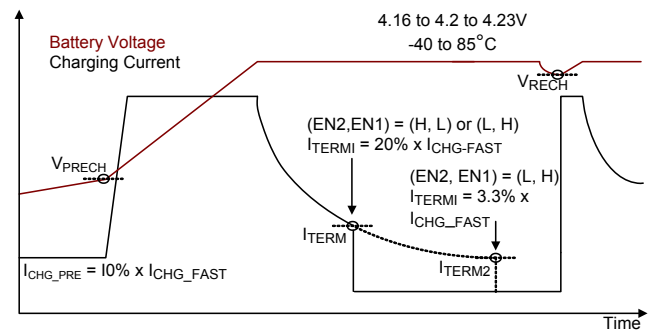

APPM Profile

1.5A Mode

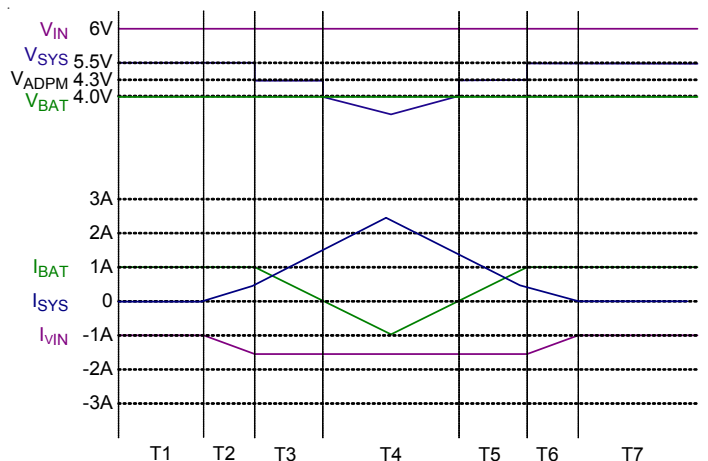

	I _{sys}	V _{sys}
T1, T7	0	SYS Regulation Voltage
T2, T6	< I _{VIN_OC} - CHG_MAX	SYS Regulation Voltage
T3, T5	> I _{VIN_OC} - CHG_MAX < I _{VIN_OC}	Auto Charge Voltage Threshold
T4	> I _{VIN_OC}	V _{BAT} - I _{BAT} × R _{DS(ON)}

	I _{VIN}	I _{BAT}
T1, T7	CHG_MAX	CHG_MAX
T2, T6	I _{sys} + CHG_MAX	CHG_MAX
T3, T5	VIN_OC	VIN_OC - I _{sys}
T4	VIN_OC	I _{sys} - I _{VIN_OC}

USB 500mA Mode

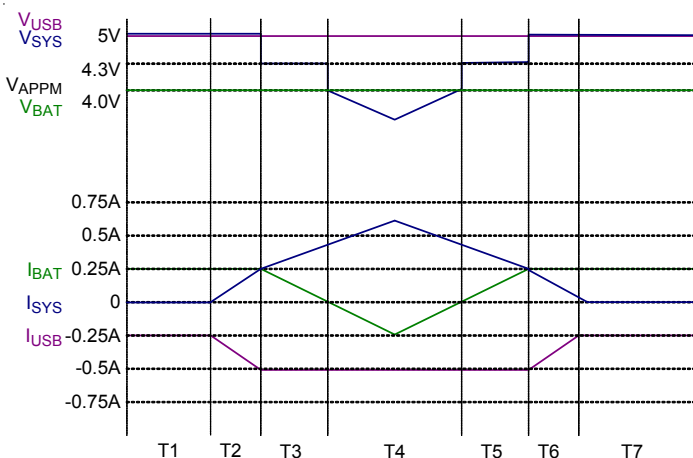

	I _{sys}	V _{sys}
T1, T7	0	SYS Regulation Voltage
T2, T6	< USB_OC - CHG_MAX	SYS Regulation Voltage
T3, T5	> USB_OC - CHG_MAX < USB_OC	Auto Charge Voltage Threshold
T4	> USB_OC	V _{BAT} - I _{BAT} × R _{DS(ON)}

	I _{usb}	I _{BAT}
T1, T7	CHG_MAX	CHG_MAX
T2, T6	I _{sys} + CHG_MAX	CHG_MAX
T3, T5	USB_OC	USB_OC - I _{sys}
T4	USB_OC	I _{sys} - USB_OC

Thermal Considerations

For continuous operation, do not exceed absolute maximum junction temperature. The maximum power dissipation depends on the thermal resistance of the IC package, PCB layout, rate of surrounding airflow, and difference between junction and ambient temperature. The maximum power dissipation can be calculated by the following formula :

$$P_{D(MAX)} = (T_{J(MAX)} - T_A) / \theta_{JA}$$

where T_{J(MAX)} is the maximum junction temperature, T_A is the ambient temperature, and θ_{JA} is the junction to ambient thermal resistance.

For recommended operating condition specifications, the maximum junction temperature is 125°C. The junction to ambient thermal resistance, θ_{JA} , is layout dependent. For WQFN-16L 3x3 packages, the thermal resistance, θ_{JA} , is 68°C/W on a standard JEDEC 51-7 four-layer thermal test board. The maximum power dissipation at T_A = 25°C can be calculated by the following formula :

$$P_{D(MAX)} = (125^\circ\text{C} - 25^\circ\text{C}) / (68^\circ\text{C/W}) = 1.471\text{W for WQFN-16L 3x3 package}$$

The maximum power dissipation depends on the operating ambient temperature for fixed T_{J(MAX)} and thermal resistance, θ_{JA} . The derating curve in Figure 2 allows the designer to see the effect of rising ambient temperature on the maximum power dissipation.

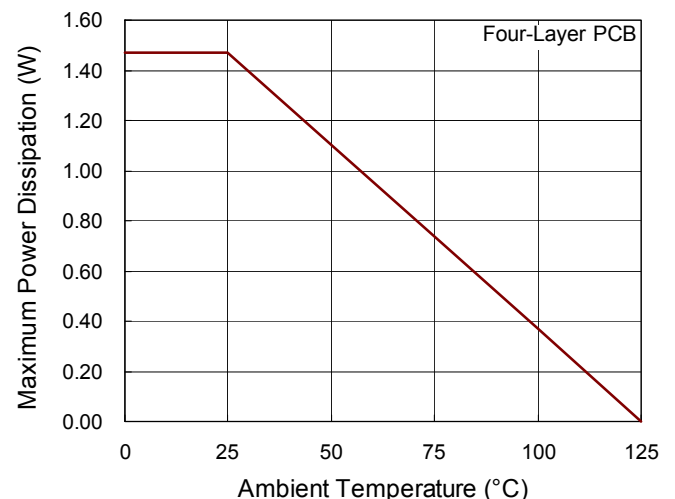

Figure 2. Derating Curve of Maximum Power Dissipation

Layout Considerations

The RT9525 is a fully integrated low cost single cell Li-Ion battery charger ideal for portable applications. Careful PCB layout is necessary. For best performance, place all peripheral components as close to the IC as possible. A short connection is highly recommended. The following guidelines should be strictly followed when designing a PCB layout for the RT9525.

- ▶ Input and output capacitor should be placed close to IC and connected to ground plane. The trace of input in the PCB should be placed far away from the sensitive devices AND shielded by the ground.
- ▶ The GND and exposed pad should be connected to a strong ground plane for heat sinking and noise protection.
- ▶ The connection of R_{ISETA} should be isolated from other noisy traces. A short wire is recommended to prevent EMI and noise coupling.

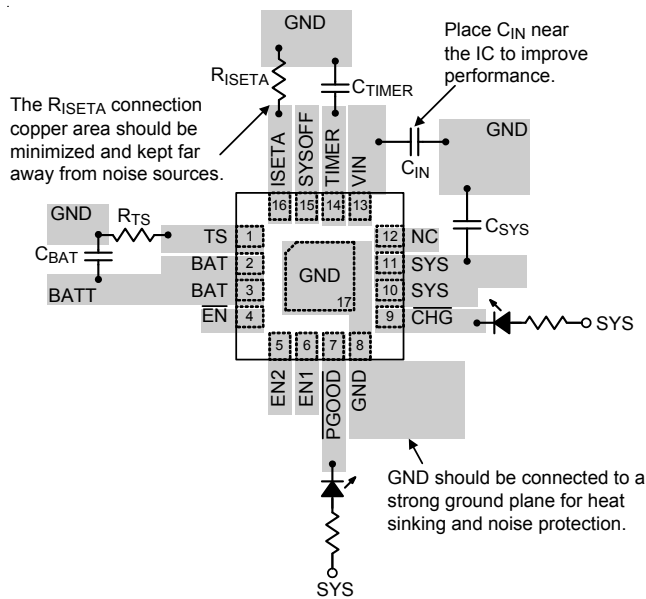
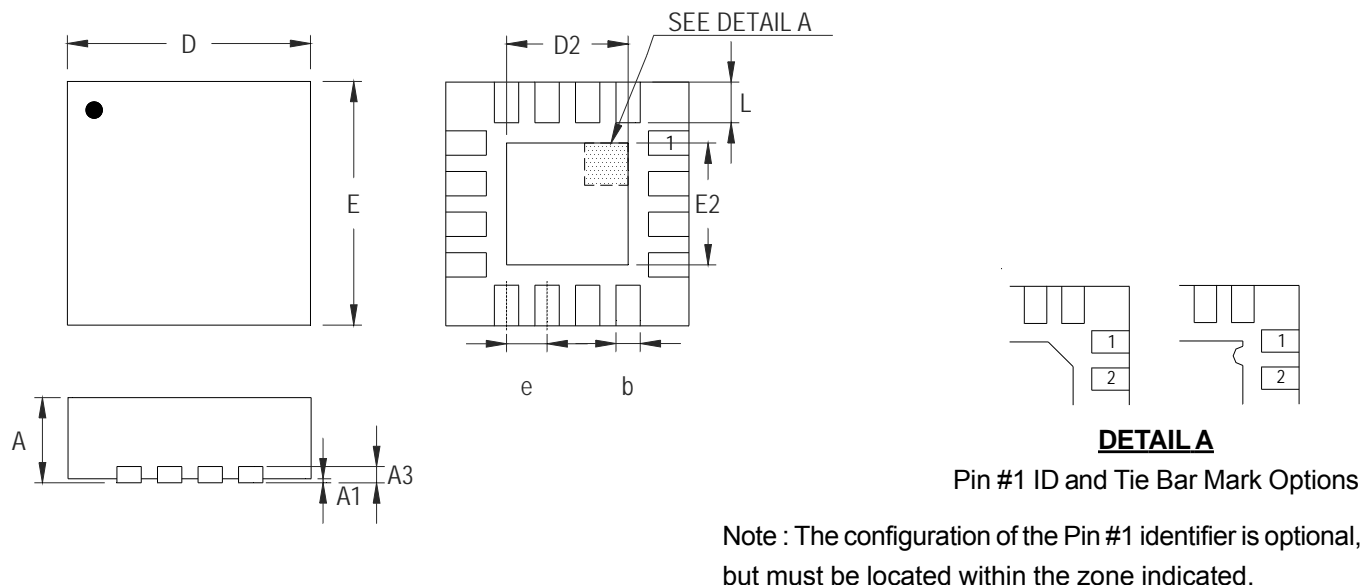

Figure 3. PCB Layout Guide

Outline Dimension



Symbol	Dimensions In Millimeters		Dimensions In Inches	
	Min	Max	Min	Max
A	0.700	0.800	0.028	0.031
A1	0.000	0.050	0.000	0.002
A3	0.175	0.250	0.007	0.010
b	0.180	0.300	0.007	0.012
D	2.950	3.050	0.116	0.120
D2	1.300	1.750	0.051	0.069
E	2.950	3.050	0.116	0.120
E2	1.300	1.750	0.051	0.069
e	0.500		0.020	
L	0.350	0.450	0.014	0.018

W-Type 16L QFN 3x3 Package

Richtek Technology Corporation

14F, No. 8, Tai Yuen 1st Street, Chupei City
 Hsinchu, Taiwan, R.O.C.
 Tel: (8863)5526789

Richtek products are sold by description only. Richtek reserves the right to change the circuitry and/or specifications without notice at any time. Customers should obtain the latest relevant information and data sheets before placing orders and should verify that such information is current and complete. Richtek cannot assume responsibility for use of any circuitry other than circuitry entirely embodied in a Richtek product. Information furnished by Richtek is believed to be accurate and reliable. However, no responsibility is assumed by Richtek or its subsidiaries for its use; nor for any infringements of patents or other rights of third parties which may result from its use. No license is granted by implication or otherwise under any patent or patent rights of Richtek or its subsidiaries.