

7-CH DC/DC Converter for DSC

General Description

The RT9986A is a complete power supply solution for digital still cameras and other handheld devices. It includes one synchronous step-up DC/DC converter with load disconnect, one selectable synchronous step-up/step-down DC/DC converter, two synchronous step-down DC/DC converters, one synchronous high voltage step-up DC/DC converter, one inverting DC/DC converter, and one selectable synchronous high voltage step-up/current-source for WLED. In addition, the RT9986A also includes one RTC_LDO, one voltage detector, and one System Reset. All power MOSFETs are integrated in the RT9986A.

The RT9986A is designed to fulfill the applications for DSC as follows :

CH1 is a synchronous step-up output for motor or DSC system I/O power

CH2 is a selectable synchronous step-up/step-down output for motor or DSC system I/O power

CH3 and CH4 are synchronous step-down outputs for DSP core and memory power supply

CH5 is a synchronous high voltage step-up output for CCD bias power supply

CH6 is an inverting output for negative CCD bias power supply

CH7 is a selectable synchronous high voltage step-up/current source for driving WLED

The selectable step-up/step-down converter can be auto selected by external component topology. For the RT9986A, all 7-CHs have built in internal compensation. The RT9986A also provides a transformerless inverting converter for supplying CCD power. For the low voltage synchronous step-up and step down converters, efficiency can be up to 95%.

The RT9986A provides comprehensive protection features including over current protection, thermal shutdown protection, over voltage protection, overload protection, and under voltage protection.

Features

- **CH2 Step-Up/Step-Down Auto-Selected by External Topology**
- **Preset On/Off Sequence of CH1, CH2, CH3, CH4 (1 → 3 → 4 → 2)**
- **Preset On/Off Sequence of CH5, CH6 (5 → 6)**
- **All Channels with Internal Compensation**
- **All Power Switches Integrated**
- **All Step-Up Converter with Load Disconnect**
- **Step-Down DC/DC Converter**
 - ▶ **Up to 95% Efficiency**
 - ▶ **100% (max) Duty Cycle**
- **Low Voltage Step-Up DC/DC Converter**
 - ▶ **Adjustable Output Voltage**
 - ▶ **Up to 95% Efficiency**
- **WLED Driver**
 - ▶ **Auto-Selected by External Topology**
 - ▶ **Current Source Mode with 30mA DC Current**
 - ▶ **Step-Up Mode with LED Open Protection (OVP7)**
 - ▶ **Direct PWM Dimming Control**
- **Fixed 2MHz Switching Frequency for CH1/2/3/4, Fixed 1MHz Switching Frequency for CH5/6/7**
- **Small 32-Lead WQFN Package**
- **RoHS Compliant and Halogen Free**

Applications

- Digital Still Camera
- PDA
- Portable Devices

Marking Information

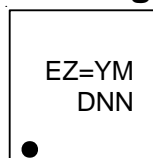

EZ= : Product Code
YMDNN : Date Code

Ordering Information

RT9986A □ □

Package Type
 QW : WQFN-32L 4x4 (W-Type)

Lead Plating System
 G : Green (Halogen Free and Pb Free)

Note :

Richtek products are :

- ▶ RoHS compliant and compatible with the current requirements of IPC/JEDEC J-STD-020.
- ▶ Suitable for use in SnPb or Pb-free soldering processes.

Pin Configurations

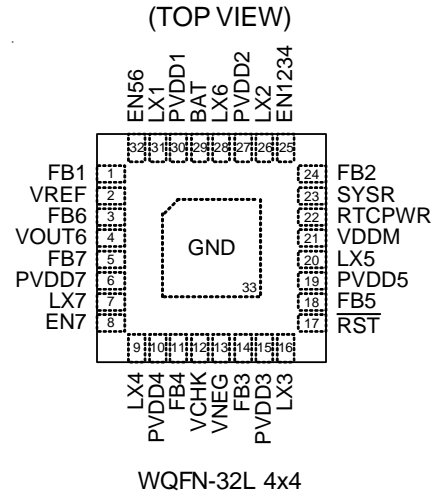

Typical Application Circuit

For 2AA

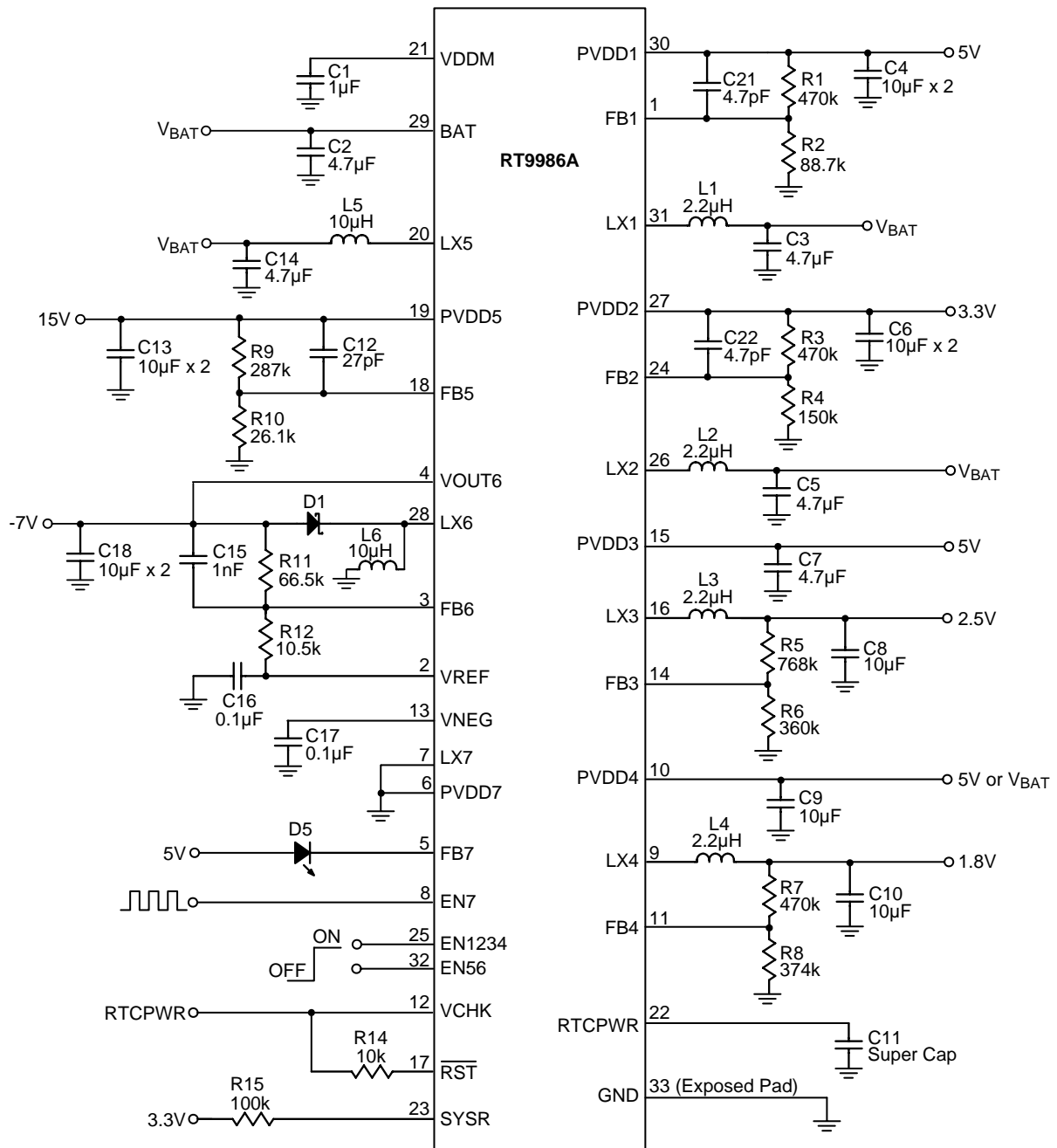

For Li-ion

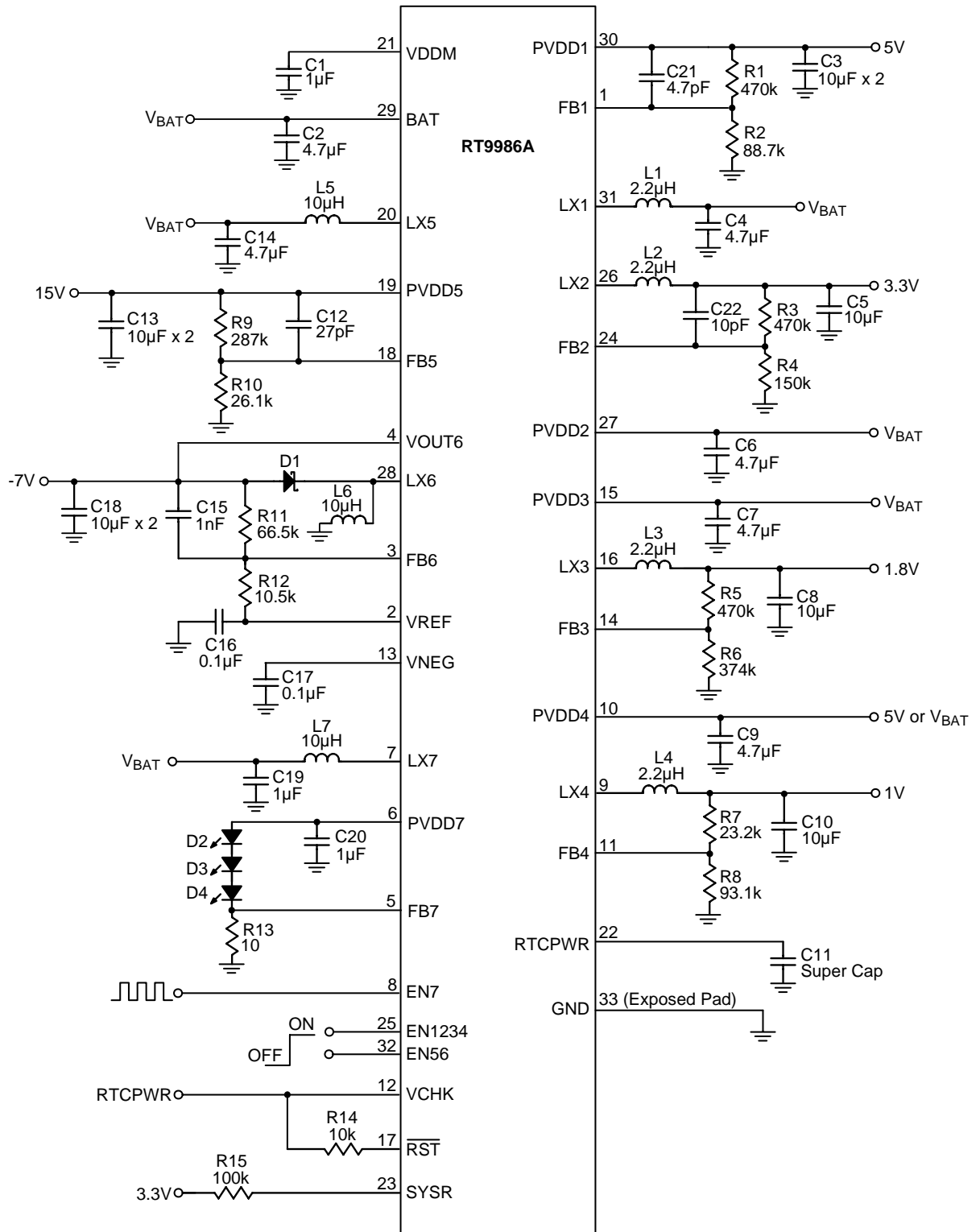

Timing Diagram

Timing Diagram for CH1 to CH4

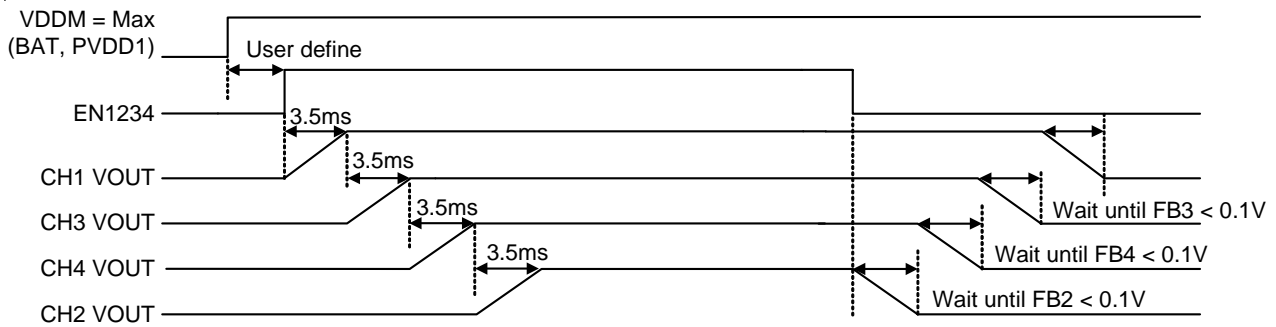

CH5 and CH6 Power Sequence

The power on sequence is :

When EN56 goes high, CH5 will turn on first. After 10ms, CH6 will turn on.

The power off sequence is :

When EN56 goes low, CH6 will turn off first and VOUT6 will be internally pulled to GND.

When VOUT6 > -0.12V, CH6 discharging completes and then CH5 turns off. Finally, the whole IC shuts down.

Power On Sequence : CH5 HV Step-Up 15V → CH6 INV -7V

Power Off Sequence : CH6 INV -7V → CH5 HV Step-Up 15V

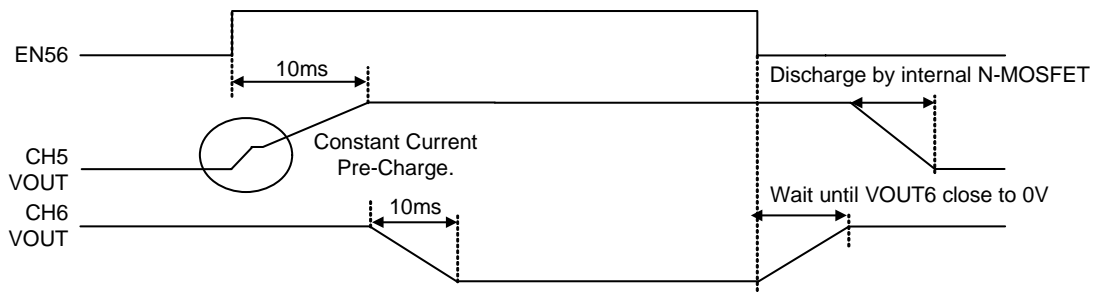

Functional Pin Description

Pin No.	Pin Name	Pin Function
1	FB1	Feedback Input Pin of CH1.
2	VREF	1.8V Reference Output Pin.
3	FB6	Feedback Input Pin of CH6.
4	VOUT6	Sense Input Pin of CH6 Inverting Output Node.
5	FB7	Feedback input pin of CH7 in step-up mode or current sink pin of CH7 in current source mode.
6	PVDD7	Power Output Pin of CH7.
7	LX7	Switch Node of CH7 in Step-Up Mode. LX7 initial voltage determines CH7 operation mode.
8	EN7	Enable Pin of CH7 and PWM Dimming Signal Input Pin.
9	LX4	Switch Node of CH4.
10	PVDD4	Power Input Pin of CH4.
11	FB4	Feedback Input Pin of CH4.
12	VCHK	Sense Pin of Voltage Detector.
13	VNEG	Output Pin of Negative Regulator.
14	FB3	Feedback Input Pin of CH3.
15	PVDD3	Power Input Pin of CH3.
16	LX3	Switch Node of CH3.
17	RST	Voltage Detector Open Drain Output Pin.
18	FB5	Feedback Input Pin of CH5.
19	PVDD5	Power Output Pin of CH5.
20	LX5	Switch Node of CH5.
21	VDDM	IC Analog Power Pin.
22	RTCPWR	Internal Control Circuit Power Pin. That must connect to a bypass capacitor for better noise rejection.
23	SYSR	System Reset Open-Drain Output Pin.
24	FB2	Feedback Input Pin of CH2.
25	EN1234	Enable Pin of CH1, CH2, CH3, CH4.
26	LX2	Switch Node of CH2.
27	PVDD2	Power Input Pin for Step-Down of CH2. Power Output Pin for Step-Up of CH2.
28	LX6	Switch Node of CH6.
29	BAT	Battery Power Pin.
30	PVDD1	Power Output Pin of CH1.
31	LX1	Switch Node of CH1.
32	EN56	Enable Pin of CH5, CH6.
33 (Exposed pad)	GND	Ground. The exposed pad must be soldered to a large PCB and connected to GND for maximum thermal dissipation.

Function Block Diagram

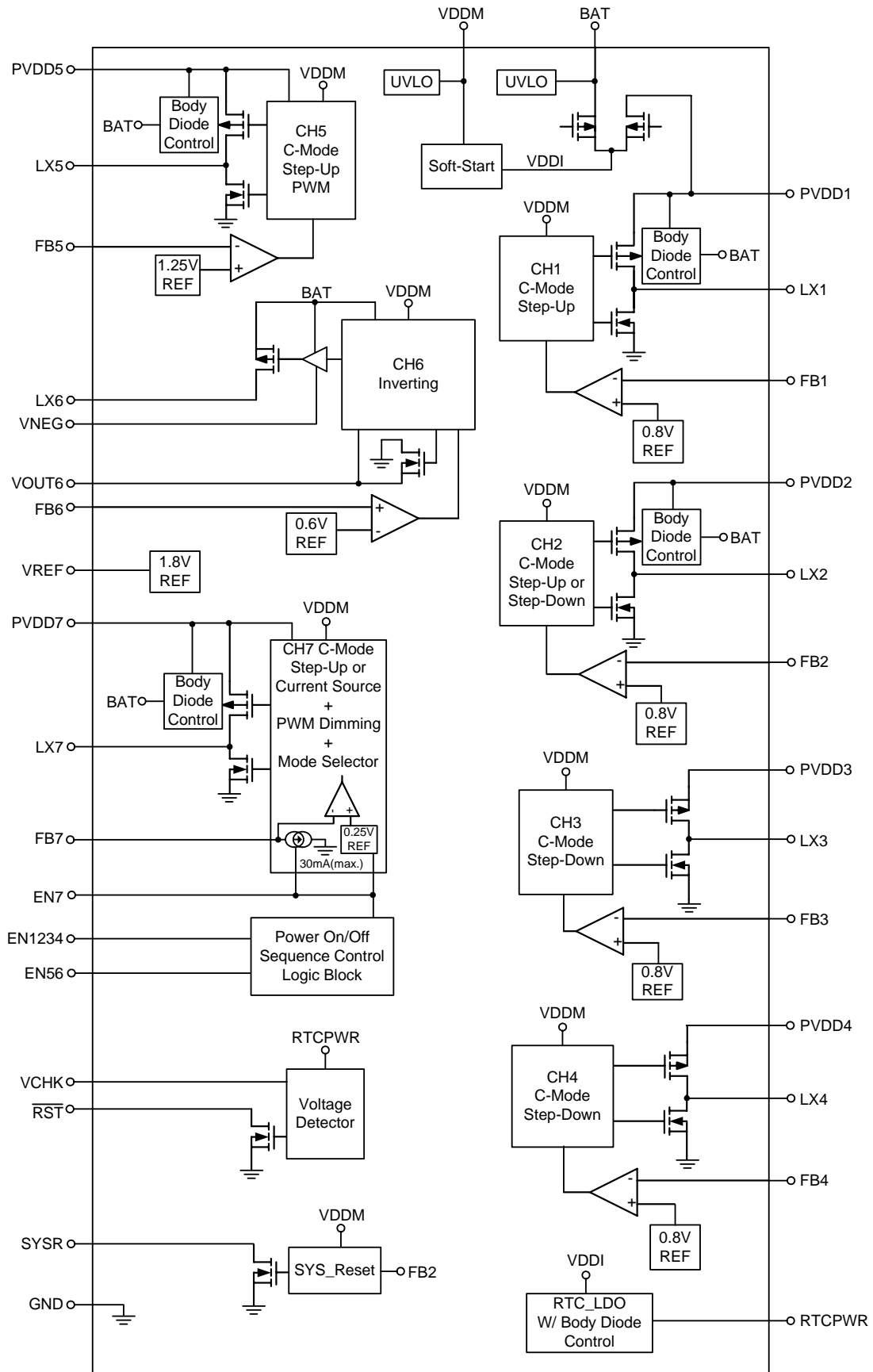

Absolute Maximum Ratings (Note 1)

- Supply Input Voltage, VDDM, BAT ----- -0.3V to 6V
- VOUT6 ----- -10V to 0.3V
- LX1, LX2, LX3, LX4 ----- -0.3V to 6V
- PVDD5, LX5 ----- -0.3V to 24V
- PVDD7, LX7 ----- -0.3V to 17V
- LX6 ----- (BAT – 14V) to (BAT + 0.3V)
- Other Pins ----- -0.3V to 6V
- Power Dissipation, P_D @ T_A = 25°C
 - WQFN 32L 4x4 ----- 3.590W
- Package Thermal Resistance (Note 2)
 - WQFN 32L 4x4, θ_{JA} ----- 27.8°C/W
 - WQFN 32L 4x4, θ_{JC} ----- 7°C/W
- Junction Temperature ----- 150°C
- Lead Temperature (Soldering, 10 sec.) ----- 260°C
- Storage Temperature Range ----- -65°C to 150°C
- ESD Susceptibility (Note 3)
 - HBM (Human Body Mode) ----- 2kV
 - MM (Machine Mode) ----- 200V

Recommended Operating Conditions (Note 4)

- VDDM ----- 2.7V to 5.8V
- Junction Temperature Range ----- -40°C to 125°C
- Ambient Temperature Range ----- -40°C to 85°C

Electrical Characteristics

(V_{DDM} = V_{BAT} = 3.3V, T_A = 25°C, unless otherwise specified)

Parameter	Symbol	Test Conditions	Min	Typ	Max	Unit
Supply Input Voltage						
BAT Startup Voltage	V _{ST}		1.5	--	--	V
BAT UVLO Threshold		BAT Falling	--	1.3	--	V
BAT UVLO Hysteresis			--	0.2	--	V
VDDM OVP Threshold		VDDM Rising	5.85	6	6.15	V
VDDM OVP Hysteresis			--	-0.25	--	V
VDDM UVLO Threshold		VDDM Rising	2.2	2.4	2.6	V
VDDM UVLO Hysteresis			--	0.3	--	V
Supply Current						
Shutdown Supply Current (I _{BAT} + I _{VDDM})	I _{OFF}	All EN pins = 0, V _{BAT} = 3.3V	--	10	20	μA
CH1 Synchronous Step-Up Supply Current into VDDM	I _{Q1}	Non switching, V _{EN1234} = 3.3V	--	--	800	μA
CH2 Synchronous Step-Up or Step-Down Supply Current into VDDM	I _{Q2}	Non switching, V _{EN1234} = 3.3V	--	--	800	μA
CH3 Synchronous Step-Down Supply Current into VDDM	I _{Q3}	V _{EN1234} = 3.3V	--	--	800	μA

To be continued

Parameter	Symbol	Test Conditions	Min	Typ	Max	Unit	
CH4 Synchronous Step-Down Supply Current into VDDM	I _{Q4}	Non switching, V _{EN1234} = 3.3V	--	--	800	μA	
CH5 Synchronous Step-Up Supply Current into VDDM	I _{Q5}	Non switching, V _{EN56} = 3.3V	--	--	800	μA	
CH6 (Inverting) Supply Current into VDDM	I _{Q6}	Non switching, V _{EN56} = 3.3V	--	--	800	μA	
CH7 (WLED) in Step-Up Mode Supply Current into VDDM	I _{Q7b}	Non switching, V _{EN7} = 3.3V	--	--	800	μA	
CH7 (WLED) in Current Source Mode Supply Current into VDDM	I _{Q7c}	V _{EN7} = 3.3V, V _{LX7} = 0V	--	--	800	μA	
Oscillator							
CH1, 2, 3, 4 Operation Frequency	f _{OSC}		1800	2000	2200	kHz	
CH5, 6, 7 Operation Frequency	f _{OSC2}	CH7 in Step-Up mode	900	1000	1100	kHz	
CH1 Maximum Duty Cycle (Step-Up)		V _{FB1} = 0.75V	80	83	86	%	
CH2 Maximum Duty Cycle (Step-Up)		V _{FB2} = 0.75V	80	83	86	%	
CH2 Maximum Duty Cycle (Step-Down)		V _{FB2} = 0.75V	--	--	100	%	
CH3 Maximum Duty Cycle (Step-Down)		V _{FB3} = 0.75V	--	--	100	%	
CH4 Maximum Duty Cycle (Step-Down)		V _{FB4} = 0.75V	--	--	100	%	
CH5 Maximum Duty Cycle (Step-Up)		V _{FB5} = 1.15V	91	93	97	%	
CH6 Maximum Duty Cycle (Inverting)		V _{FB6} = 0.7V	91	93	97	%	
CH7 Maximum Duty Cycle (Step-Up)		V _{FB7} = 0.15V	91	93	97	%	
Feedback, Regulation Voltage							
Feedback Regulation Voltage @ FB1, FB2, FB3, FB4			0.788	0.8	0.812	V	
Feedback Regulation Voltage @ FB5	V _{FB5}		1.237	1.25	1.263	V	
Feedback Regulation Voltage @ FB6 (Inverting)	V _{FB6}		0.59	0.6	0.61	V	
Feedback Regulation Voltage @ FB7	V _{FB7}		0.237	0.25	0.263	V	
Output Current (CS Mode)			28.5	30	31.5	mA	
Dropout Voltage @ FB7 (CS Mode)		V _{LX7} = 0V	--	--	0.3	V	
VREF Output Voltage	V _{REF}		1.782	1.8	1.818	V	
VREF Load Regulation		0μA < I _{REF} < 200μA	--	--	10	mV	
Power Switch							
CH1 On-Resistance	P-MOSFET	R _{DS(ON)1}	V _{PVDD1} = 3.3V	--	200	300	mΩ
	N-MOSFET		V _{PVDD1} = 3.3V	--	150	250	
CH1 Current Limitation (Step-Up)		I _{LIM1}		2.2	3	4	A
CH2 On Resistance	P-MOSFET	R _{DS(ON)2}	V _{PVDD2} = 3.3V	--	200	300	mΩ
	N-MOSFET		V _{PVDD2} = 3.3V	--	150	250	
CH2 Current Limitation (Step-Down)		I _{LIM2_D}		1.2	1.6	2	A
CH2 Current Limitation (Step-Up)		I _{LIM2_U}		2.2	3	4	A

To be continued

Parameter		Symbol	Test Conditions	Min	Typ	Max	Unit
CH3 On Resistance	P-MOSFET	R _{DS(ON)3}	V _{PVDD3} = 3.3V	--	300	400	mΩ
	N-MOSFET		V _{PVDD3} = 3.3V	--	300	400	
CH3 Current Limitation (Step-Down)		I _{LIM3}		1.2	1.6	2	A
CH4 On Resistance	P-MOSFET	R _{DS(ON)4}	V _{PVDD4} = 3.3V	--	300	400	mΩ
	N-MOSFET		V _{PVDD4} = 3.3V	--	300	400	
CH4 Current Limitation (Step-Down)		I _{LIM4}		1.2	1.6	2	A
CH5 On Resistance	P-MOSFET	R _{DS(ON)5}	V _{PVDD5} = 16V	--	0.8	1	Ω
	N-MOSFET		V _{PVDD5} = 3.3V	--	0.6	0.8	
CH5 Current Limitation of N-MOSFET		I _{LIM5}		0.9	1.2	1.6	A
CH6 On Resistance of P-MOSFET		R _{DS(ON)6}		--	0.5	0.7	Ω
CH6 Current Limitation of P-MOSFET		I _{LIM6}		1	1.5	2	A
CH7 On Resistance	P-MOSFET	R _{DS(ON)7}	V _{PVDD7} = 10V	--	3	--	Ω
	N-MOSFET		V _{PVDD7} = 3.3V	--	0.9	1.1	
CH7 Current Limitation of N-MOSFET		I _{LIM7}		0.6	0.8	1	A
Protection							
Over Voltage Protection of PVDD1 and PVDD2				5.85	6	6.15	V
Over Voltage Protection of PVDD5				20	21	22	V
Over Voltage Protection of VOUT6				--	-13	--	V
Over Voltage Protection of PVDD7 (Step-Up Mode)				14.3	15	16	V
CH1, CH2 Step-Up Under Voltage Protection of PVDD1 and PVDD2				--	V _{BAT} -0.8V	--	V
CH1/2/3/4 Under Voltage Protection			At V _{FBx} < 0.4V after soft-start ends	0.35	0.4	0.45	V
CH5 Under Voltage Protection			At V _{FB5} < 0.6V after soft-start ends	0.5	0.6	0.7	V
CH6 Under Voltage Protection			At V _{FB6} > 1.2V after soft-start end	1.1	1.2	1.3	V
CH1/2/3/4 Over Load Protection			At V _{FBx} < 0.7V after fault delay (100ms)	0.65	0.7	0.75	V
CH5 Over Load Protection			At V _{FB5} < 1.1V after fault delay (100ms)	1.05	1.1	1.15	V
CH6 Over Load Protection			At V _{FB6} > 0.74V after fault delay (100ms)	0.69	0.74	0.79	V
Protection Fault Delay				--	100	--	ms
Control							
EN1234, EN56, EN7 Input Threshold Voltage	Logic-High			1.3	--	--	V
	Logic-Low			--	--	0.4	
LX7 Input Threshold Voltage	Logic-High		High to Select Step-Up Mode	1	--	--	V
	Logic-Low		Low to Select CS Mode	--	0.25	--	
EN1234, EN56, EN7 Sink Current				--	2	6	μA
EN7 Low Time for Shutdown		t _{SHDN}		--	32	--	ms

To be continued

Parameter	Symbol	Test Conditions	Min	Typ	Max	Unit
Thermal Protection						
Thermal Shutdown	T _{SD}		125	160	--	°C
Thermal Shutdown Hysteresis	ΔT _{SD}		--	20	--	°C
System Reset						
SYSR, FB2 Regulation Threshold		for SYSR to go low	0.709	0.72	0.731	V
SYSR, FB2 Hysteresis			--	40	--	mV
SYSR Rising Delay Time			--	10	--	ms
SYSR Sink Capability		V _{SYSR} = 0.5V	4	--	--	mA
Voltage Detector						
Voltage Detector Reset Threshold (VCHK < Threshold → RST = L)		VCHK Falling	1.57	1.6	1.63	V
Voltage Detector Reset Hysteresis			--	16	--	mV
Standby Current		V _{VCHK} = 3V	--	2	4	μA
RST Rising Delay Time			35	55	75	ms
RST Sink Capability		V _{RST} = 0.5V, V _{VCHK} = 1.5V	4	--	--	mA
RTC LDO						
Standby Current		V _{DDM} = 4.2V	--	5	8	μA
Regulated Output Voltage @ RTCPWR		I _{OUT} = 0mA	3.1	3.2	3.3	V
Max Output Current (Current Limit)		V _{DDM} = 4.2V	60	130	200	mA
Dropout Voltage		I _{OUT} = 50mA	--	--	1000	mV
		I _{OUT} = 10mA	--	--	150	
		I _{OUT} = 3mA	--	--	60	

Note 1. Stresses listed as the above “Absolute Maximum Ratings” may cause permanent damage to the device. These are for stress ratings. Functional operation of the device at these or any other conditions beyond those indicated in the operational sections of the specifications is not implied. Exposure to absolute maximum rating conditions for extended periods may remain possibility to affect device reliability.

Note 2. θ_{JA} is measured in natural convection at T_A = 25°C on a high-effective thermal conductivity four-layer test board of JEDEC 51-7 thermal measurement standard. The measurement case position of θ_{JC} is on the exposed pad of the package.

Note 3. Devices are ESD sensitive. Handling precaution is recommended.

Note 4. The device is not guaranteed to function outside its operating conditions.

Typical Operating Characteristics

CH1 Step-Up Efficiency vs. Output Current

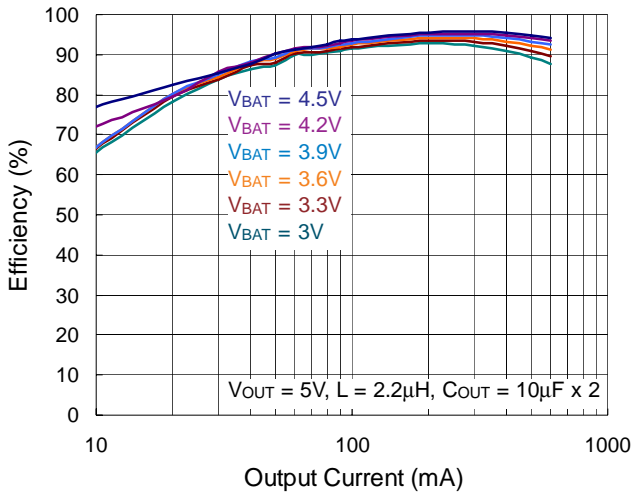

CH1 Step-Up Efficiency vs. Output Current

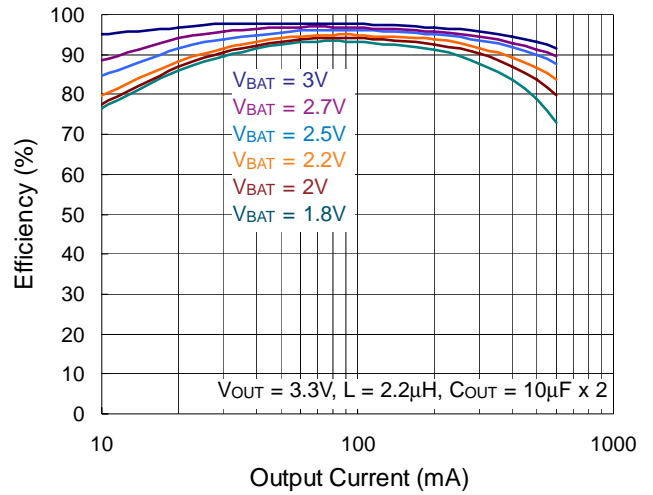

CH2 Step-Up Efficiency vs. Output Current

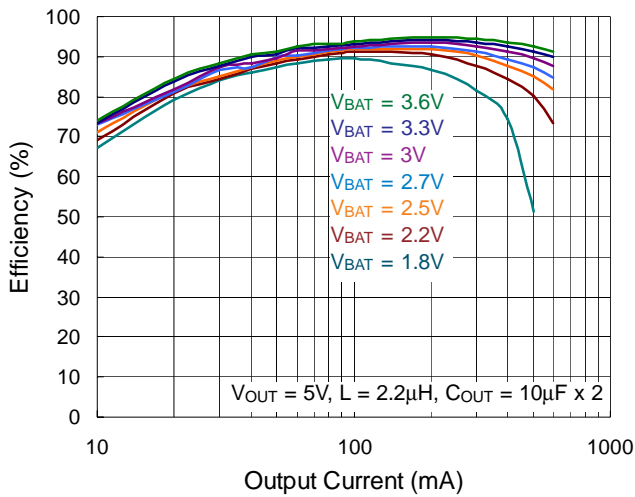

CH2 Step-Down Efficiency vs. Output Current

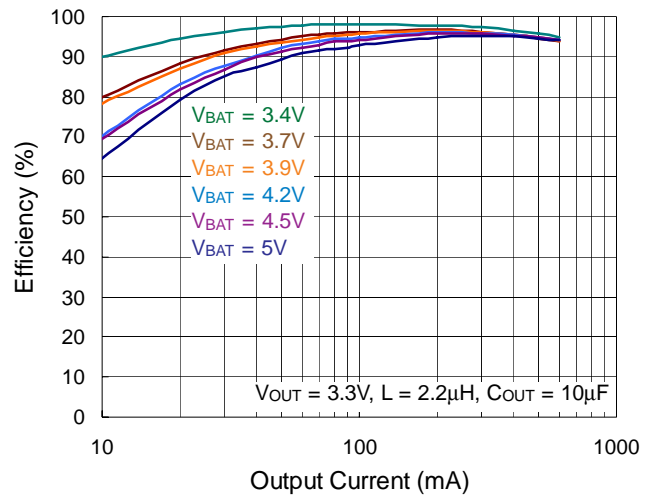

CH 3 Step-Down Efficiency vs. Output Current

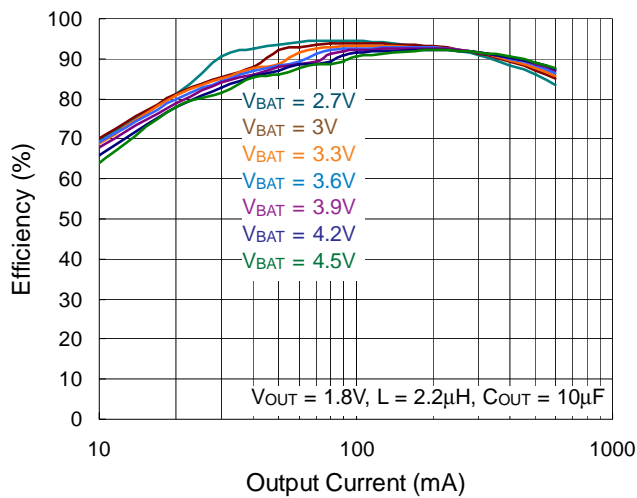

CH4 Step-Down Efficiency vs. Output Current

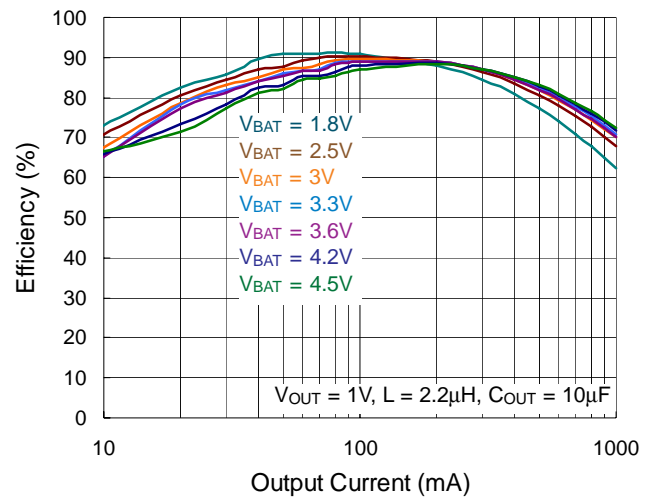

CH5 Step-Up Efficiency vs. Output Current

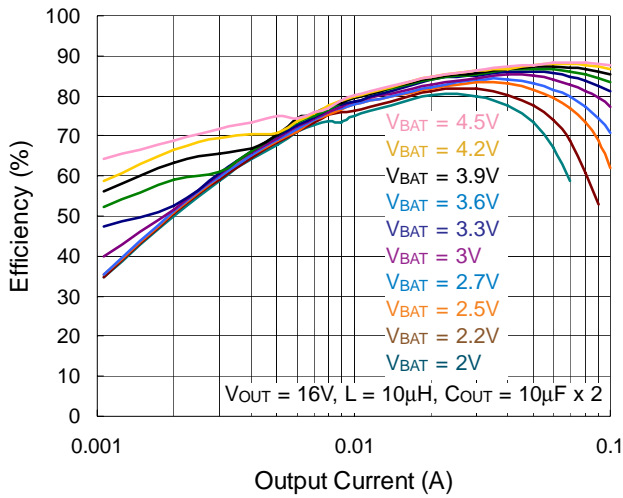

CH6 Inverting Efficiency vs. Output Current

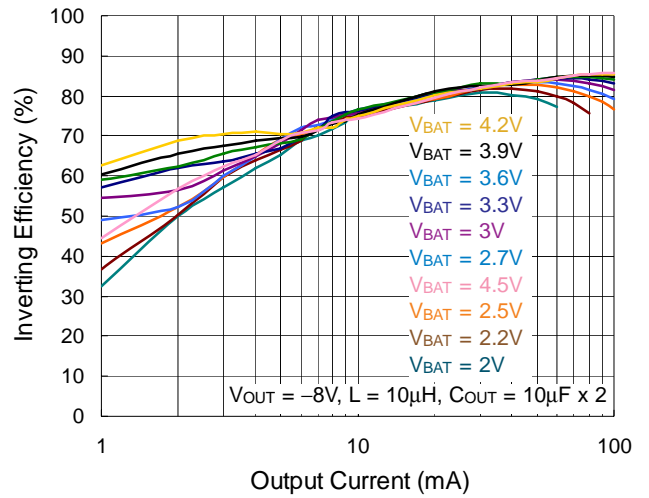

CH7 Efficiency vs. Input Voltage

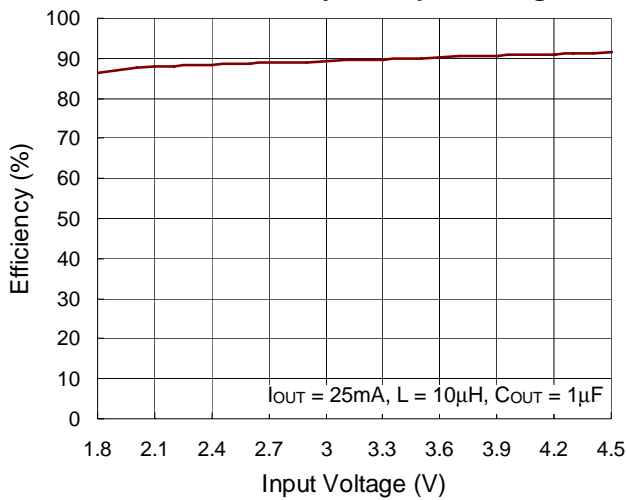

CH1 Step-Up Output Voltage vs. Output Current

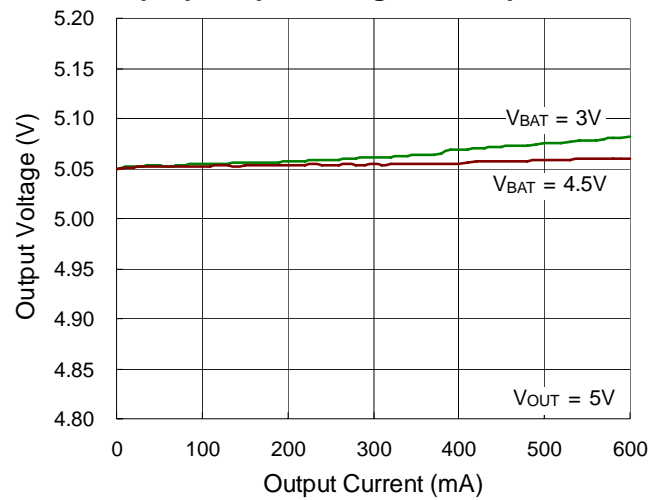

CH1 Step-Up Output Voltage vs. Output Current

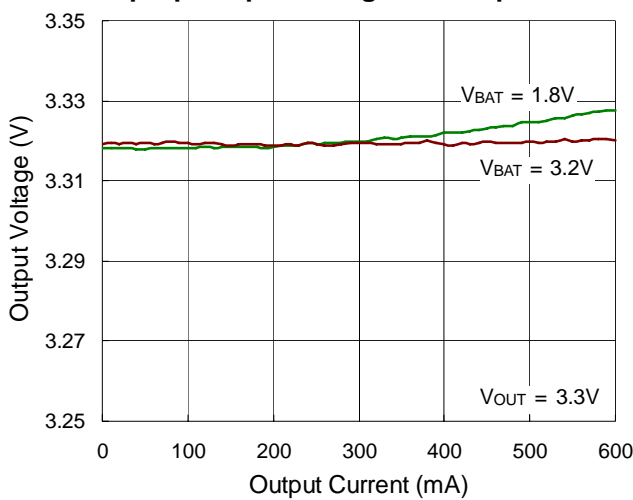

CH2 Step-Up Output Voltage vs. Output Current

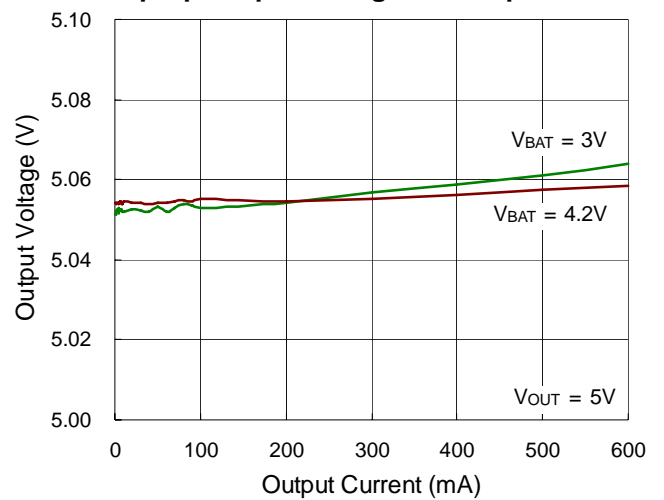

CH2 Step-Down Output Voltage vs. Output Current

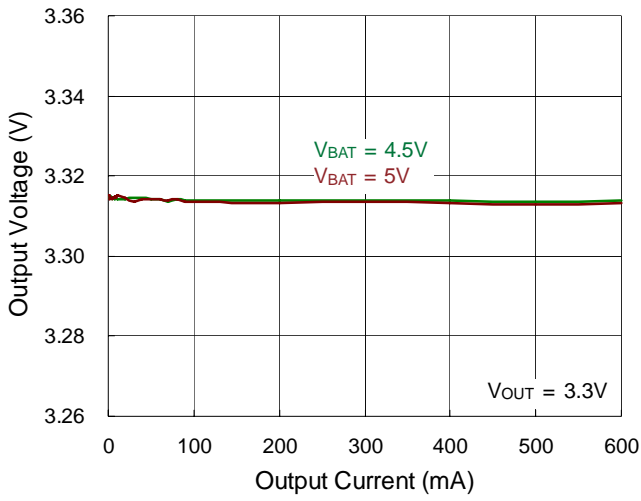

CH3 Step-Down Output Voltage vs. Output Current

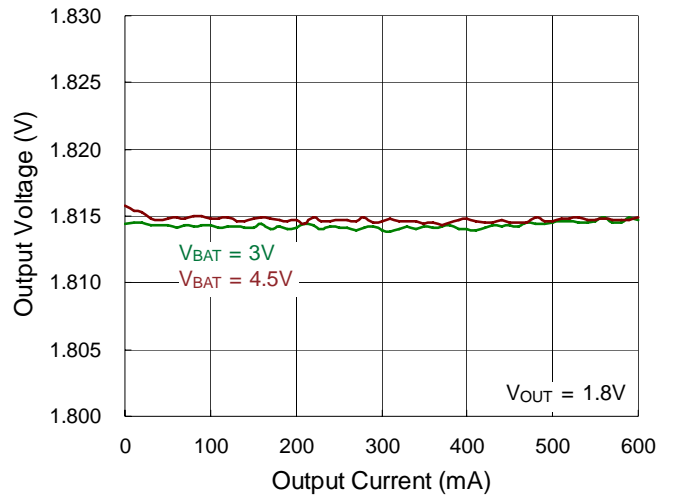

CH4 Step-Down Output Voltage vs. Output Current

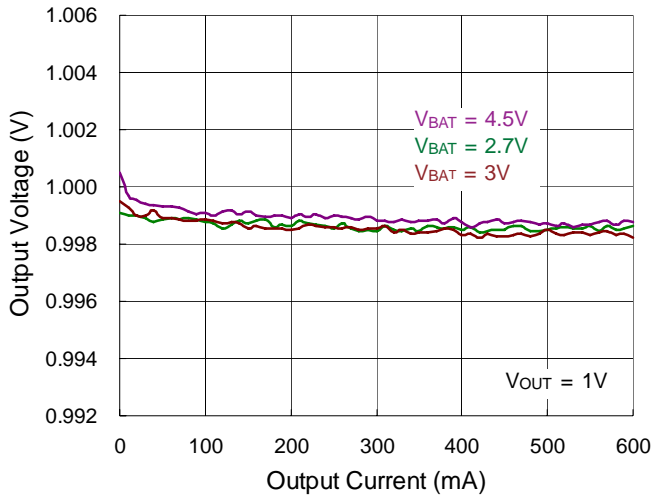

CH5 Step-Up Output Voltage vs. Output Current

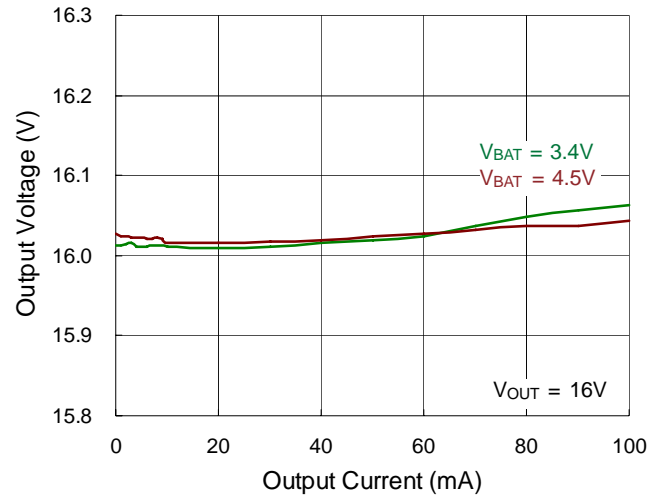

CH6 Inverting Efficiency vs. Output Current

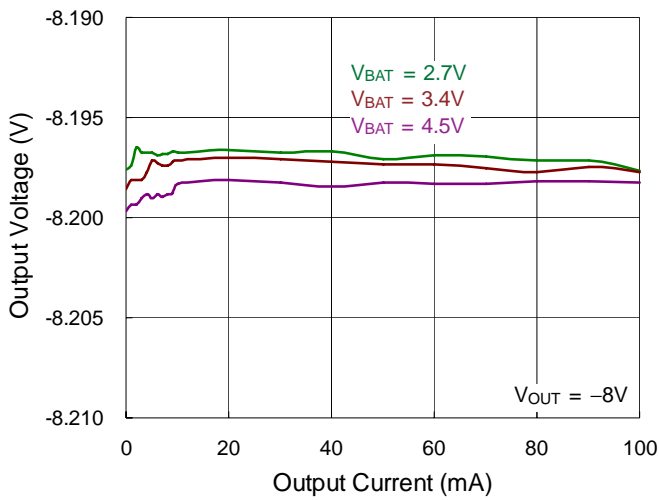

Power On Sequence

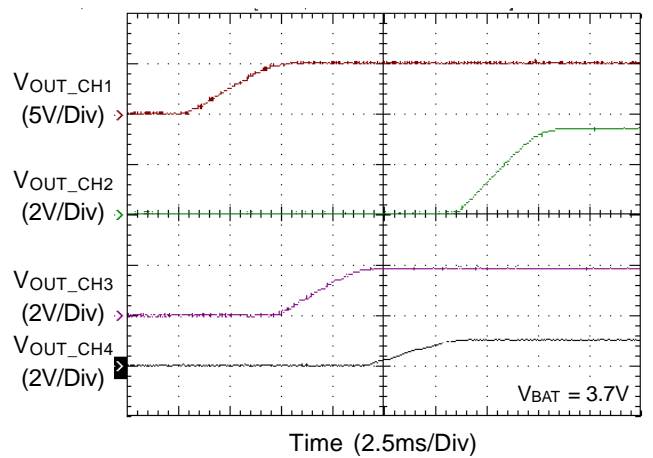

Power Off Sequence

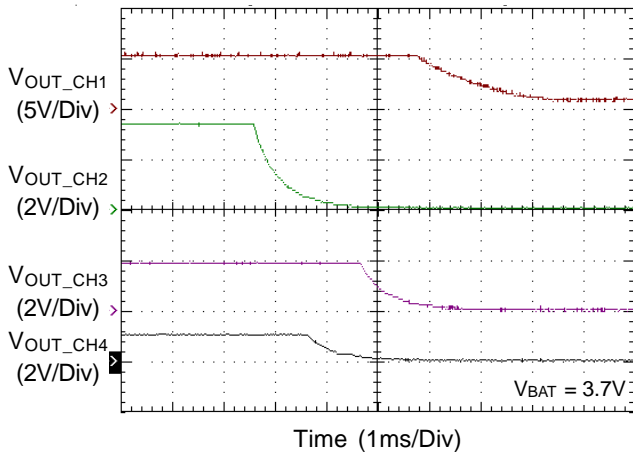

Power On Sequence

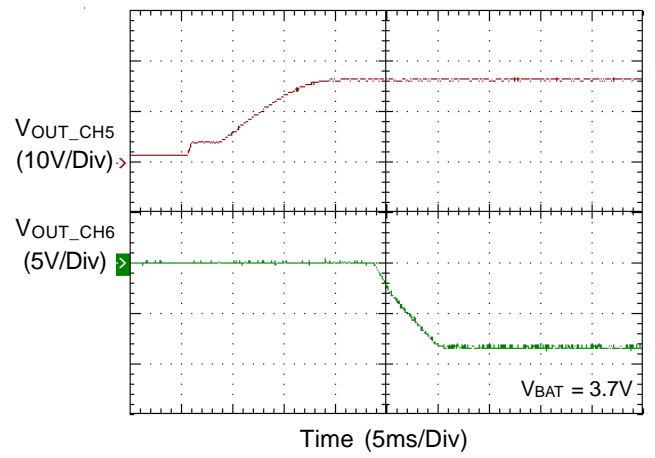

Power Off Sequence

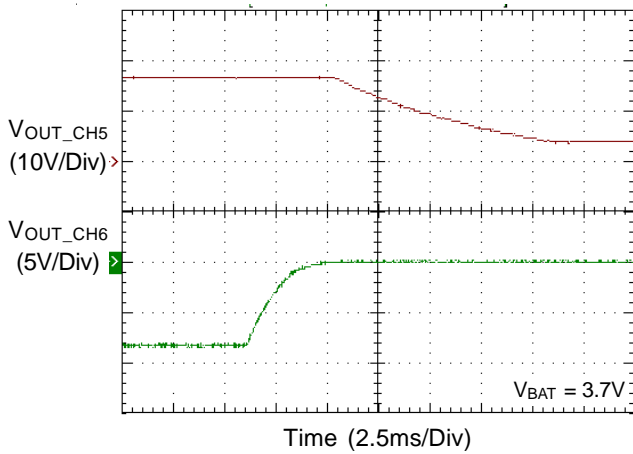

CH1 Output Voltage Ripple

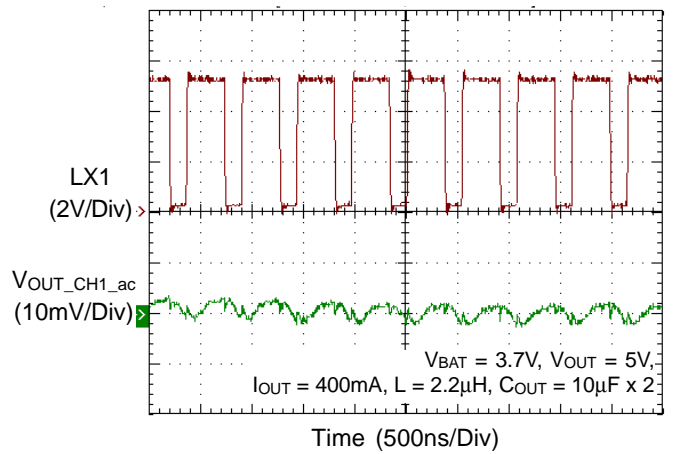

CH2 Output Voltage Ripple

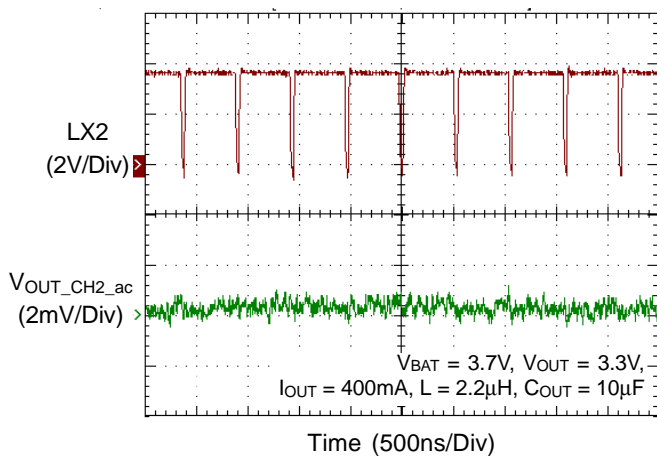

CH3 Output Voltage Ripple

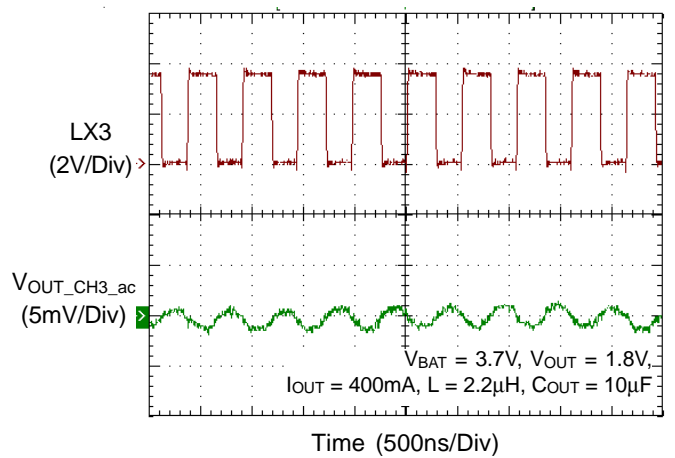

CH4 Output Voltage Ripple

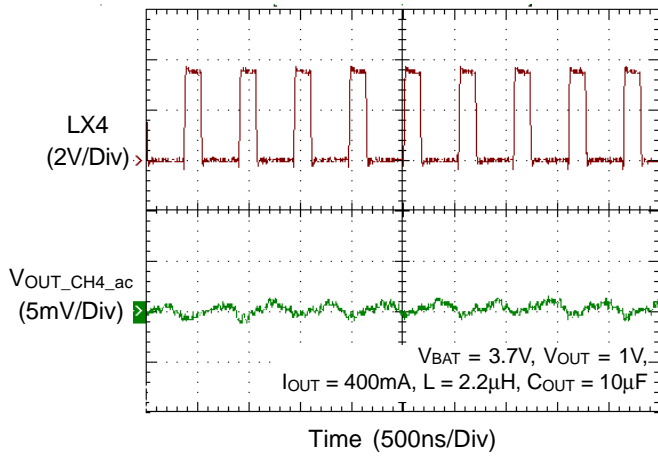

CH5 Output Voltage Ripple

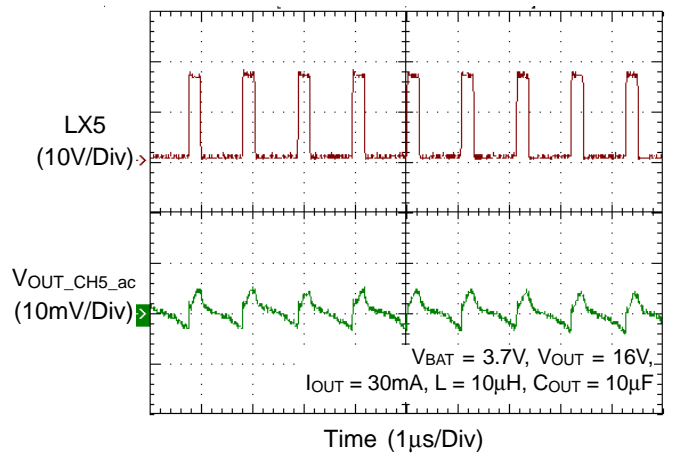

CH6 Output Voltage Ripple

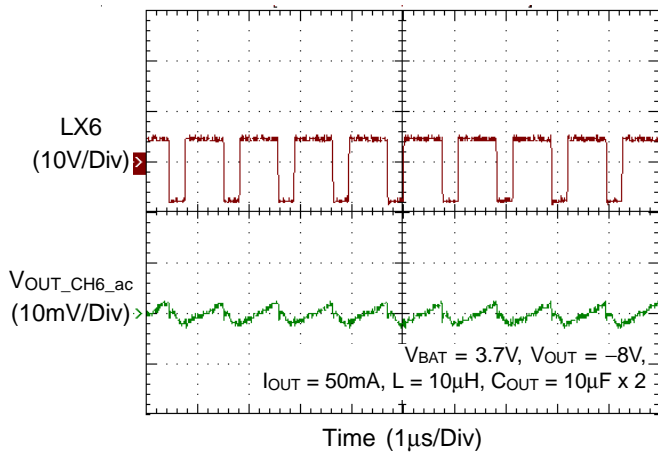

CH1 Load Transient Response

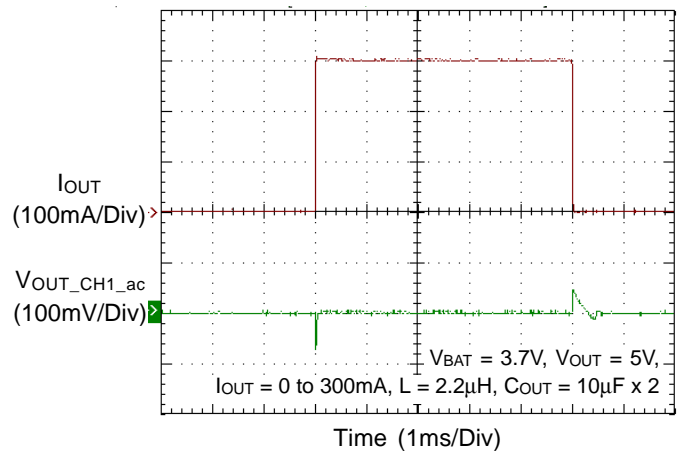

CH2 Load Transient Response

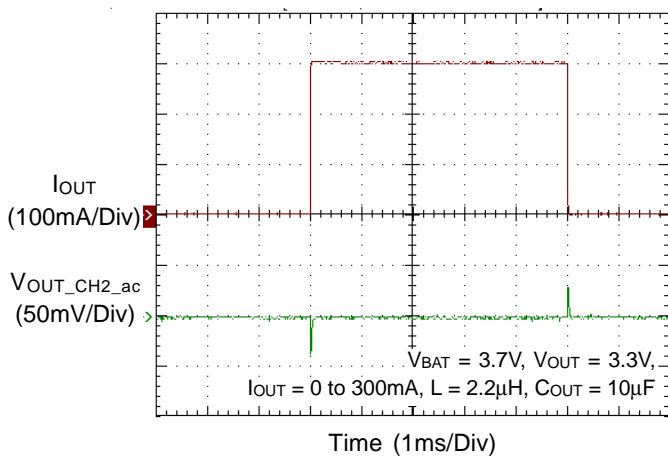

CH3 Load Transient Response

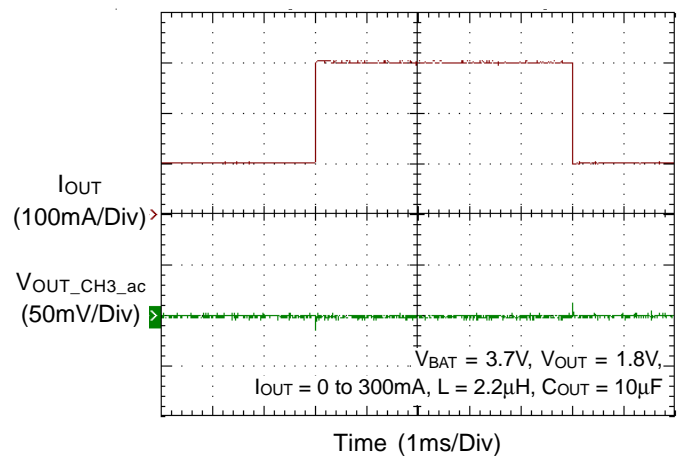

CH4 Load Transient Response

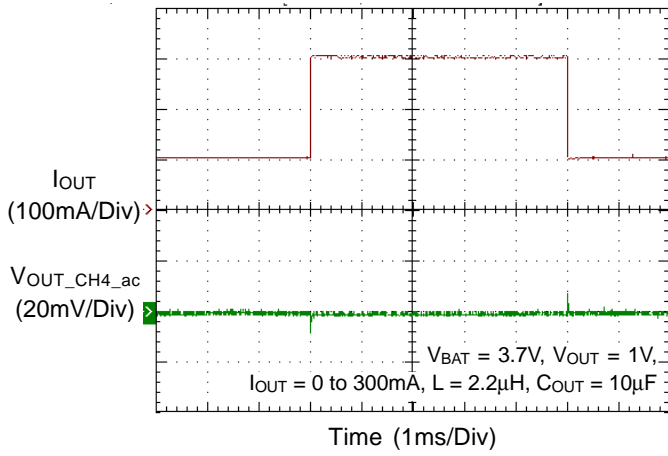

CH5 Load Transient Response

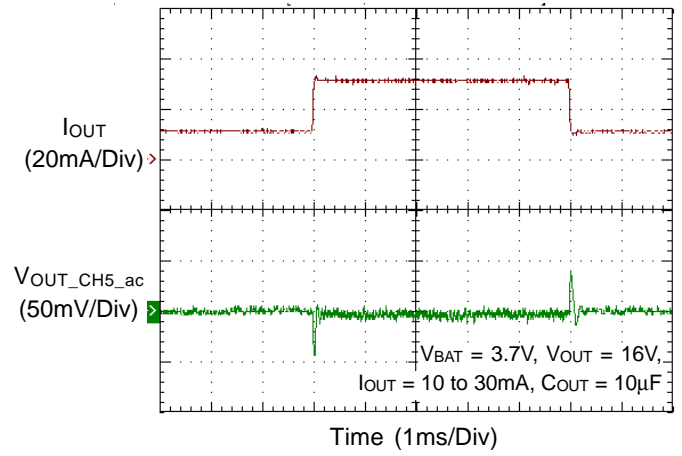

CH6 Load Transient Response

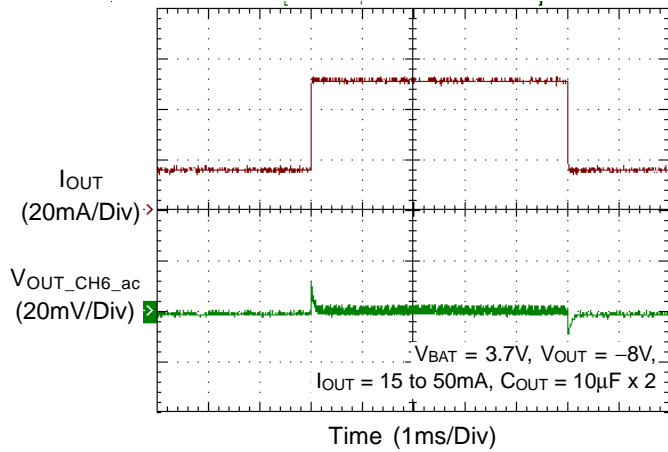

Application Information

The RT9986A is a multiple output power supply system for digital still cameras and other small handheld devices. It includes six DC/DC converters as well as one WLED driver, one RTC LDO, one voltage detector, and one system reset. The WLED works in either current source mode or step-up mode.

CH1 : Step-up synchronous current mode DC/DC converter with internal power MOSFETs and compensation network. The P-MOSFET body can be controlled to disconnect the load.

CH2 : Step-up or step-down synchronous current mode DC/DC converter with internal power MOSFETs and compensation network. External circuit topology automatically determines whether CH2 is in step-up or step-down mode. During step-up mode, the P-MOSFET body can be controlled to disconnect the load if input voltage is not higher than the V_{BAT} .

CH3 : Step-down synchronous current mode DC/DC converter with internal power MOSFETs and compensation network.

CH4 : Step-down synchronous current mode DC/DC converter with internal power MOSFETs and compensation network.

CH5 : Step-up synchronous current mode DC/DC converter with internal power MOSFET and compensation network. The P-MOSFET body can be controlled to disconnect the load.

CH6 : Asynchronous inverting current mode DC/DC converter with internal power MOSFET and compensation network.

CH7 : A WLED driver operating in either current source mode or synchronous step-up mode with internal power MOSFET and compensation network. Operation mode is determined by LX7 initial voltage. The P-MOSFET body in step-up mode can be controlled to disconnect the load disconnected.

CH1 to CH4 operate in PWM mode with 2MHz, while CH5 to CH7 operate in PWM mode with 1MHz switching frequency.

RTC_LDO : A 3.1V output LDO with low quiescent current and high output voltage accuracy.

System Reset : Accurate voltage detector for checking CH2 output voltage status.

Voltage Detector : A general, low quiescent current voltage detector for monitoring status of a node voltage such as for RTC_LDO output or others.

CH1 : Synchronous Step-Up DC/DC Converter

CH1 is a synchronous step-up converter which can be used for motor power. The converter operates at fixed frequency and PWM current mode. The converter integrates internal MOSFETs, compensation network and synchronous rectifier for up to 95% efficiency.

The output voltage can be set by the following equation :

$$V_{OUT_CH1} = (1 + R1 / R2) \times V_{FB1}$$

where V_{FB1} is 0.8V typically.

CH2 : Synchronous Step-Up / Step-Down Selectable DC/DC Converter

CH2 is a synchronous step-up / step-down auto-select converter, typically for system I/O power. In either step-up or step-down, the converter operates in fixed frequency PWM mode, Continuous Current Mode (CCM), and Discontinuous Current Mode (DCM) with internal MOSFETs, compensation network and synchronous rectifiers for up to 95% efficiency.

Step-Up :

In step-up mode, CH2 also disconnects the load from its input power node and discharges output node of CH2 when it is turned off.

Step-Down :

In step-down mode, the CH2 converter can be operated at 100% maximum duty cycle to extend the input operating voltage range. When the input voltage is close to the output voltage, the converter enters low dropout mode.

The output voltage can be set by the following equation :

$$V_{OUT_CH2} = (1 + R3 / R4) \times V_{FB2}$$

where V_{FB2} is 0.8V typically.

CH3 : Synchronous Step-Down DC/DC Converter

CH3 operates in fixed frequency PWM mode with integrated internal MOSFETs and compensation network. The CH3 step-down converter can be operated at 100% maximum duty cycle to extend battery operating voltage range. When the input voltage is close to the output voltage, the converter enters low dropout mode with low output ripple.

The output voltage can be set by the following equation :

$$V_{OUT_CH3} = (1 + R5 / R6) \times V_{FB3}$$

where V_{FB3} is 0.8V typically.

CH4 : Synchronous Step-Down DC/DC Converter

CH4 operates at fixed frequency PWM mode with integrated internal MOSFETs and compensation network. The CH4 step-down converter can be operated at 100% maximum duty cycle to extend battery operating voltage range. When the input voltage is close to the output voltage, the converter enters low dropout mode with low output ripple.

The output voltage can be set by the following equation:

$$V_{OUT_CH4} = (1 + R7 / R8) \times V_{FB4}$$

where V_{FB4} is 0.8V typically.

CH5 : Synchronous Step-Up DC/DC Converter

CH5 is a high voltage synchronous step-up converter for CCD positive power. The converter operates at fixed frequency PWM mode, CCM, DCM, and PSM (pulse skip mode) with integrated internal MOSFETs, compensation network and load disconnect function.

The output voltage can be set by the following equation:

$$V_{OUT_CH5} = (1 + R9 / R10) \times V_{FB5}$$

where V_{FB5} is 1.25V typically.

CH6 : INV DC/DC Converter

This converter integrates an internal P-MOSFET with internal compensation and needs an external Schottky diode to provide CCD negative power supply.

The output voltage can be set by the following equation :

$$V_{OUT_CH6} = -(R11 / R12) \times (1.2V) + 0.6V$$

where R11 and R12 are the feedback resistors connected

to FB6, 1.2V equals to $(V_{REF} - V_{FB6})$ and 0.6V is V_{FB6} typical.

Reference Voltage

The RT9986A provides a precise 1.8V reference voltage, V_{REF} , with sourcing capability of 100 μ A. Connect a 0.1 μ F ceramic capacitor from the VREF pin to GND. Reference voltage is enabled by pulling EN6 to logic-high. Furthermore, this reference voltage is internally pulled to GND at shutdown.

CH7 : WLED Driver

CH7 is a WLED driver that can operate in either current source mode or synchronous step-up mode, as determined by LX7's initial voltage level.

Table 1. CH7 WLED setting

CH7 Operating Mode	LX7
Current Source	< 0.25V
Synchronous Step-Up	> 1V

When CH7 works in current source mode, it sinks an accurate LED current modulated by EN7 high duty such that it is easily dimmed from 0mA to 30mA. If CH7 works in synchronous step-up mode, it integrates synchronous step-up mode with an internal MOSFET and internal compensation to output a voltage up to 15V. The LED current is set via an external resistor and controlled via the PWM duty on the EN7 pin. Regardless of the mode, holding EN7 low for more than 32ms will turn off CH7.

In addition, CH7 will be turned on until the CH2 soft-start is finished.

CH7 WLED Current Dimming Control

If CH7 is in synchronous step-up mode, the WLED current is set by an external resistor. If CH7 is in current source mode, the sink current into the FB7 pin is 30mA typically when EN7 is high. Regardless of the mode, dimming is always controlled by the duty of pulse-width modulated signal on the EN7 pin. The PWM dimming duty must be over 10%.

The average current through WLED can be set by the following equations :

$$I_{LED} (mA) = [250mV / R (W)] \times Duty (\%) \text{ (for step-up mode)}$$

$$\text{or } I_{LED} (mA) = 30mA \times Duty (\%) \text{ (for current source mode)}$$

R is the current sense resistor from FB7 to GND and Duty is the duty of the PWM dimming signal into EN7 pin.

Dimming frequency range is from 1kHz to 100kHz but 2kHz to 20kHz should be avoided to prevent distraction from audio noise.

VDDM Bootstrap

To support bootstrap function, the RT9986A includes a power selection circuit which selects between BAT and PVDD1 to create the internal node voltage VDDI and VDDM. VDDM is the power of all the RT9986A control circuits and must be connected to an external decoupling capacitor by way of the VDDM pin. The VDDI is the power input of the RTC LDO. The output PVDD1 of CH1 can bootstrap VDDM and VDDI. The RT9986A includes UVLO circuits to monitor VDDM and BAT voltage status.

RTC LDO

The RT9986A provides a 3.1V output LDO for real time clock. The LDO features low quiescent current (5µA) and high output voltage accuracy. This LDO is always on, even when the system is shut down. For better stability, it is recommended to connect a 0.1µF to the RTCPWR pin. The RTC LDO includes pass transistor body diode control to avoid the RTCPWR node from back-charging into the input node VDDI.

System Reset

The RT9986A also provides a system voltage detector to monitor system power status via FB2. If FB2 level is lower than 90% setting, the open drain output pin SYSR will pull down. When FB2 level is higher than 95% setting, the SYSR pin will go high after 10ms.

Voltage Detector

The RT9986A provides a voltage detector to detect the voltage status at the VCHK pin. The input power of the voltage detector is RTCPWR and the detector is always on. 55ms after VCHK voltage > 1.616V, the open drain output /RST will be pulled high. If VCHK < 1.6V, the /RST pin will be pulled down to GND immediately.

Power On/Off Sequence for CH1 to CH4

EN1234 will turn on/off CH1 to CH4 in preset sequence.

CH1 to CH4 Power On Sequence is:

When EN1234 goes high, CH1 will turn on first. 3.5ms after CH1 is turned on, CH3 will turn on. 3.5ms after CH3 is turned on, CH4 will turn on. 3.5ms after CH4 is turned on, CH2 will turn on.

CH1 to CH4 Power-Off Sequence is :

When EN1234 goes low, CH2 will turn off first and internally discharge output.

When FB2 < 0.1V, CH4 will turn off and also internally discharge output via the LX4 pin. When FB4 < 0.1V, CH3 will turn off and internally discharge output via the LX3 pin. Likewise, when FB3 < 0.1V, CH1 will turn off and discharge output. After FB1 < 0.1V, CH1 to 4 shutdown sequence will be completed.

Thermal Considerations

For continuous operation, do not exceed absolute maximum junction temperature. The maximum power dissipation depends on the thermal resistance of the IC package, PCB layout, rate of surrounding airflow, and difference between junction and ambient temperature. The maximum power dissipation can be calculated by the following formula :

$$P_{D(MAX)} = (T_{J(MAX)} - T_A) / \theta_{JA}$$

where $T_{J(MAX)}$ is the maximum junction temperature, T_A is the ambient temperature, and θ_{JA} is the junction to ambient thermal resistance.

For recommended operating condition specifications of the RT9986A, the maximum junction temperature is 125°C and T_A is the ambient temperature. The junction to ambient thermal resistance, θ_{JA} , is layout dependent. For WQFN-32L 4x4 packages, the thermal resistance, θ_{JA} , is 27.8°C/W on a standard JEDEC 51-7 four-layer thermal test board. The maximum power dissipation at $T_A = 25^\circ\text{C}$ can be calculated by the following formula :

$$P_{D(MAX)} = (125^\circ\text{C} - 25^\circ\text{C}) / (27.8^\circ\text{C/W}) = 3.59\text{W for WQFN-32L 4x4 package}$$

The maximum power dissipation depends on the operating ambient temperature for fixed $T_{J(MAX)}$ and thermal resistance, θ_{JA} . For the RT9986A package, the derating curve in Figure 1 allows the designer to see the effect of rising ambient temperature on the maximum power dissipation.

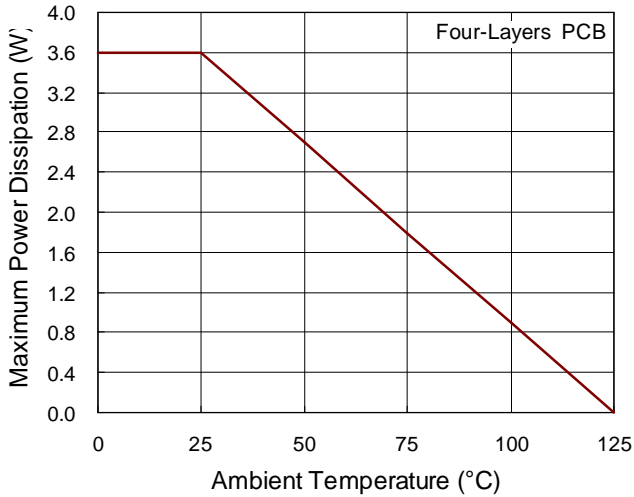

Figure 1. Derating Curves for RT9986A Packages

Layout Consideration

For the best performance of the RT9986A, the following PCB layout guidelines must be strictly followed.

- } Place the input and output capacitors as close as possible to the input and output pins respectively for good filtering.
- } Keep the main power traces as wide and short as possible.
- } The switching node area connected to LX and inductor should be minimized for lower EMI.
- } Place the feedback components as close as possible to the FB pin and keep these components away from the noisy devices.
- } Connect the GND and Exposed Pad to a strong ground plane for maximum thermal dissipation and noise protection.

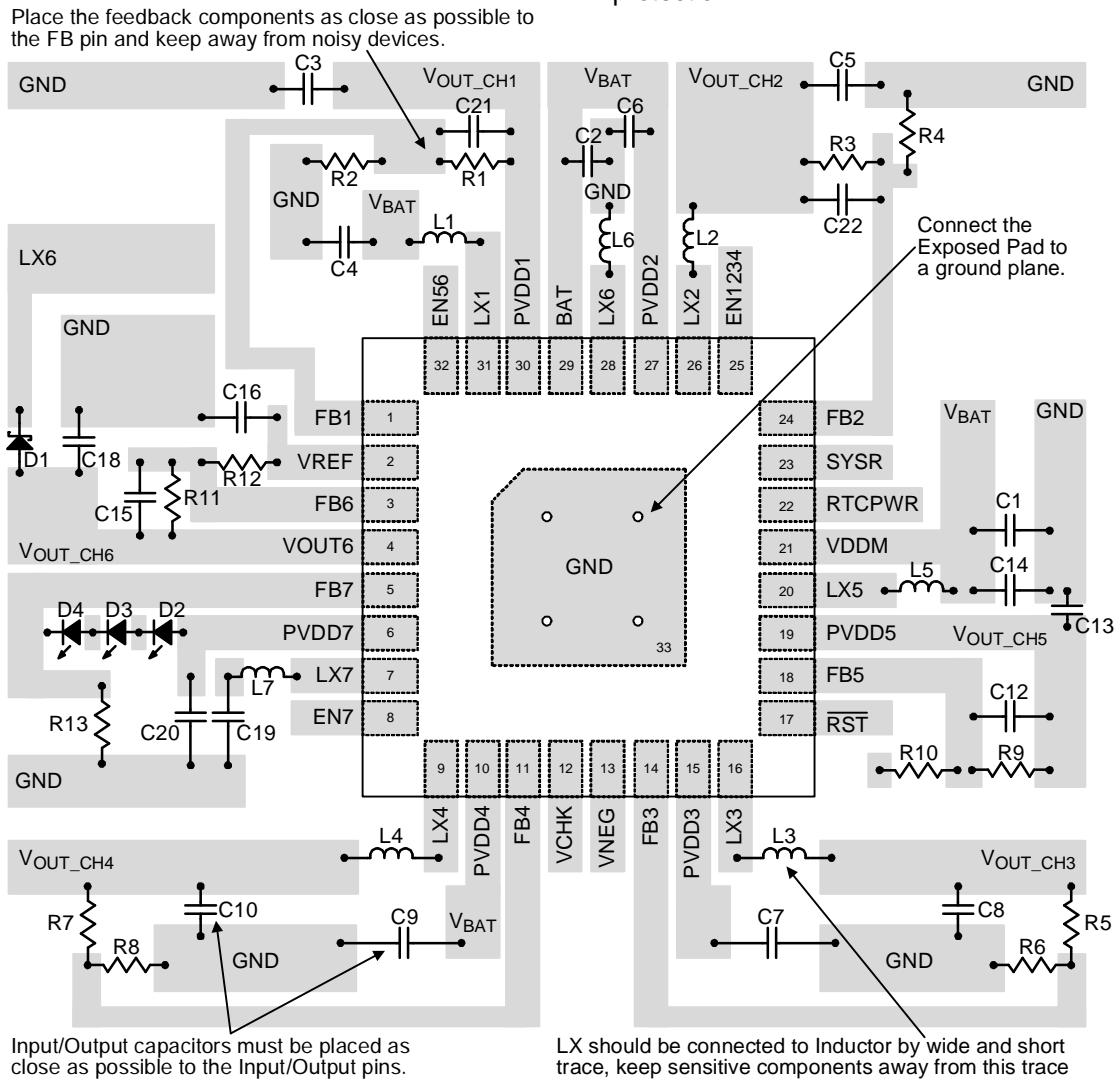

Figure 2. PCB Layout Guide

Table 2. Protection Items

	Protection type	Threshold (typical) Refer to Electrical spec	Protection methods	IC Shutdown Delay time	Reset method
BAT	UVLO	BAT < 1.3V	IC Shutdown.	No-delay	VDDM power reset or all enable pins set to low
VDDM	OVP	VDDM > 6V	Automatic reset at VDDM < 5.75V	100ms	VDDM power reset or all enable pins set to low
	UVLO	VDDM < 2.4V	IC Shutdown.	No-delay	VDDM power reset or all enable pins set to low
CH1 Step-Up	Current Limit	N-MOSFET Current > 3A	N-MOSFET off, P-MOSFET off. Automatic reset at next clock cycle.	100ms	VDDM power reset or all enable pins set to low
	PVDD1 OVP	PVDD1 > 6V	N-MOSFET off, P-MOSFET off.	No-delay	VDDM power reset or all enable pins set to low
	PVDD1 UVP	PVDD1 < (BAT – 0.8V) or PVDD1 < 1.28V after soft-start end.	N-MOSFET off, P-MOSFET off.	100ms	VDDM power reset or all enable pins set to low
	FB1 UVP	FB1 < 0.4V after soft-start end.	N-MOSFET off, P-MOSFET off.	No-delay	VDDM power reset or all enable pins set to low
	FB1 Over Load (OL)	FB1 < 0.7V	IC Shutdown when OL occur each cycle until 100ms.	100ms	VDDM power reset or all enable pins set to low
CH2 Step-Up	Current Limit	N-MOSFET Current > 3A	N-MOSFET off, P-MOSFET off. Automatic reset at next clock cycle.	100ms	VDDM power reset or all enable pins set to low
	PVDD2 OVP	PVDD2 > 6V	N-MOSFET off, P-MOSFET off.	No-delay	VDDM power reset or all enable pins set to low
	PVDD2 UVP	PVDD2 < (BAT – 0.8V) or PVDD2 < 1.28V after soft-start end.	N-MOSFET off, P-MOSFET off.	100ms	VDDM power reset or all enable pins set to low
	FB2 UVP	FB2 < 0.4V after soft-start end.	N-MOSFET off, P-MOSFET off.	No-delay	VDDM power reset or all enable pins set to low
	FB2 Over Load	FB2 < 0.7V	IC Shutdown when OL occur each cycle until 100ms.	100ms	VDDM power reset or all enable pins set to low
CH2 Step-Down	Current Limit	P-MOSFET Current > 1.6A	N-MOSFET off, P-MOSFET off. Automatic reset at next clock cycle.	100ms	VDDM power reset or all enable pins set to low
	FB2 UVP	FB2 < 0.4V after soft-start end.	N-MOSFET off, P-MOSFET off.	No-delay	VDDM power reset or all enable pins set to low
	FB2 Over Load	FB2 < 0.7V	IC Shutdown when OL occur each cycle until 100ms.	100ms	VDDM power reset or all enable pins set to low

To be continued

	Protection type	Threshold (typical) Refer to Electrical spec	Protection methods	IC Shutdown Delay time	Reset method
CH3 Step-Down	Current Limit	P-MOSFET Current > 1.6A	N-MOSFET off, P-MOSFET off. Automatic reset at next clock cycle.	100ms	VDDM power reset or all enable pins set to low
	FB3 UVP	FB3 < 0.4V after soft-start end.	N-MOSFET off, P-MOSFET off.	No-delay	VDDM power reset or all enable pins set to low
	FB3 Over Load	FB3 < 0.7V	IC Shutdown when OL occur each cycle until 100ms.	100ms	VDDM power reset or all enable pins set to low
CH4 Step-Down	Current Limit	P-MOSFET Current > 1.6A	N-MOSFET off, P-MOSFET off. Automatic reset at next clock cycle.	100ms	VDDM power reset or all enable pins set to low
	FB4 UVP	FB4 < 0.4V after soft-start end.	N-MOSFET off, P-MOSFET off.	No-delay	VDDM power reset or all enable pins set to low
	FB4 Over Load	FB4 < 0.7V	IC Shutdown when OL occur each cycle until 100ms.	100ms	VDDM power reset or all enable pins set to low
CH5 Step-Up	Current Limit	N-MOSFET Current > 1.2A	N-MOSFET off, P-MOSFET off. Automatic reset at next clock cycle.	100ms	VDDM power reset or all enable pins set to low
	PVDD5 OVP	PVDD5 > 21V	N-MOSFET off, P-MOSFET off.	No-delay	VDDM power reset or all enable pins set to low
	FB5 UVP	FB5 < 0.6V after soft-start end.	N-MOSFET off, P-MOSFET off.	No-delay	VDDM power reset or all enable pins set to low
	FB5 Over Load	FB5 < 1.1V	IC Shutdown when OL occur each cycle until 100ms.	100ms	VDDM power reset or all enable pins set to low
CH6 Inverter	Current Limit	P-MOSFET Current > 1.5A	P-MOSFET off. Automatic reset at next clock cycle.	100ms	VDDM power reset or all enable pins set to low
	VOUT6 OVP	VOUT6 < -13V	P-MOSFET off.	No-delay	VDDM power reset or all enable pins set to low
	FB6 UVP	FB6 > 1.2V	P-MOSFET off.	No-delay	VDDM power reset or all enable pins set to low
	FB6 Over Load	FB6 > 0.74V	IC Shutdown when OL occur each cycle until 100ms.	100ms	VDDM power reset or all enable pins set to low
CH7 WLED	Current Limit	N-MOSFET Current > 0.8A	N-MOSFET off, P-MOSFET off. Automatic reset at next clock cycle.	100ms	VDDM power reset or all enable pins set to low
	PVDD7 OVP	PVDD7 > 15V	Shutdown CH7	Not applicable	VDDM power reset or all enable pins set to low
Thermal	Thermal Shutdown	Temperature > 160°C	All channels stop switching	No-delay	VDDM power reset or all enable pins set to low

Outline Dimension

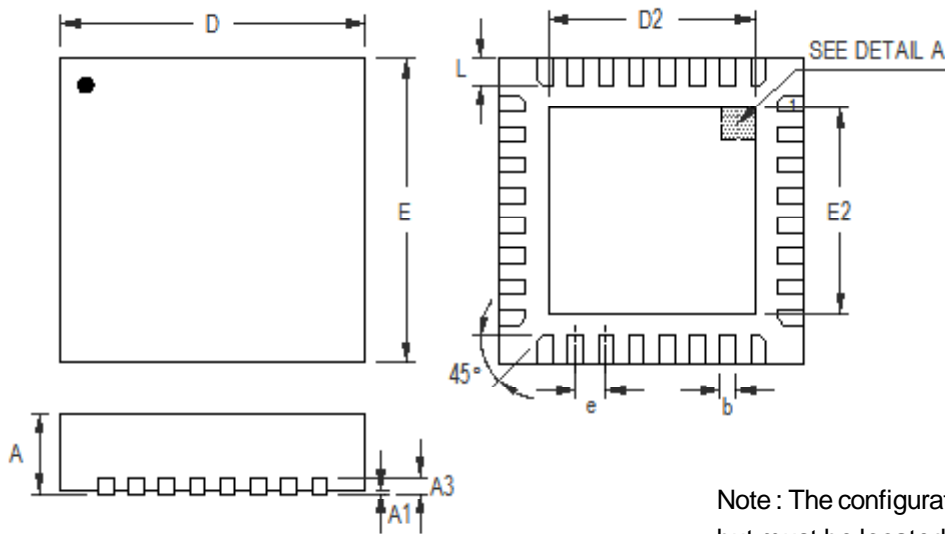

DETAIL A

Pin #1 ID and Tie Bar Mark Options

Note : The configuration of the Pin #1 identifier is optional, but must be located within the zone indicated.

Symbol	Dimensions In Millimeters		Dimensions In Inches	
	Min	Max	Min	Max
A	0.700	0.800	0.028	0.031
A1	0.000	0.050	0.000	0.002
A3	0.175	0.250	0.007	0.010
b	0.150	0.250	0.006	0.010
D	3.900	4.100	0.154	0.161
D2	2.650	2.750	0.104	0.108
E	3.900	4.100	0.154	0.161
E2	2.650	2.750	0.104	0.108
e	0.400		0.016	
L	0.300	0.400	0.012	0.016

W-Type 32L QFN 4x4 Package

Richtek Technology Corporation

Headquarter
 5F, No. 20, Taiyuen Street, Chupei City
 Hsinchu, Taiwan, R.O.C.
 Tel: (8863)5526789 Fax: (8863)5526611

Richtek Technology Corporation

Taipei Office (Marketing)
 5F, No. 95, Minchiuan Road, Hsintien City
 Taipei County, Taiwan, R.O.C.
 Tel: (8862)86672399 Fax: (8862)86672377
 Email: marketing@richtek.com

Information that is provided by Richtek Technology Corporation is believed to be accurate and reliable. Richtek reserves the right to make any change in circuit design, specification or other related things if necessary without notice at any time. No third party intellectual property infringement of the applications should be guaranteed by users when integrating Richtek products into any application. No legal responsibility for any said applications is assumed by Richtek.