

# 1A Ultra-Low Dropout Voltage LDO Regulators with Soft-Start

## 1 General Description

The RTQ2551A is a very low dropout linear regulator which operates from input voltage as low as 0.8V. The device is capable of supplying 1A of output current with a typical dropout voltage of only 50mV. A VBIAS supply is required to run the internal reference and LDO circuitry while output current comes directly from the VIN supply for high efficiency regulation. User-programmable soft-start limits the input inrush current and minimizes stress on the input power. The enable input and power good output allow easy sequencing with external regulators. This complete flexibility provides an easy-to-use robust power management solution for a wide variety of applications.

The RTQ2551A is stable with output capacitor greater than or equal to 2.2μF. A precise reference and error amplifier deliver 1% accuracy over load, line and temperature. Overcurrent limit and over-temperature protection are also included. The RTQ2551A is available in the WDFN-10L 3x3 package.

The recommended junction temperature range is -40°C to 125°C.

## 2 Features

- **Ultralow VIN Range: 0.8V to 5.5V**
- **VBIAS Voltage Range: 2.7V to 5.5V**
- **VOUT Voltage Range: 0.8V to 3.6V**
- **Low Dropout: 50mV Typ. at 1A, VBIAS = 5V**
- **1% Accuracy Over Line/Load/ Temperature**
- **PGOOD Indicator for Easy Sequence Control**
- **Programmable Soft-Start Provides Linear Voltage Startup**
- **Stable with Any Output Capacitor ≥ 2.2μF**
- **Overcurrent and Over-Temperature Protection**

## 3 Applications

- PCs, Servers, Modems, and Set-Top-Boxes
- FPGA Applications
- DSP Core and I/O Voltages
- Instrumentation
- Post-Regulation Applications
- Applications With Sequencing Requirements

## 4 Simplified Application Circuit

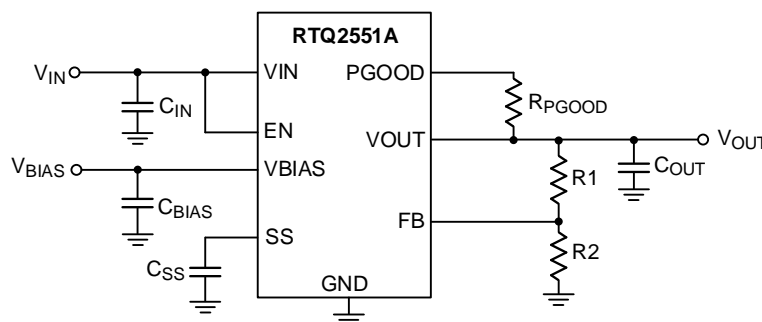

## 5 Ordering Information

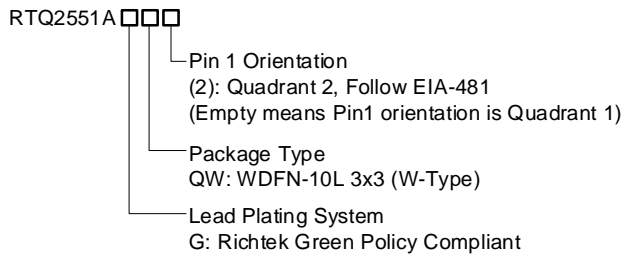

### Note:

Richtek products are Richtek Green Policy compliant and compatible with the current requirements of IPC/JEDEC J-STD-020.

## 6 Marking Information

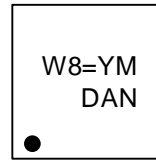

W8=: Product Code  
YMDAN: Date Code

**Table of Contents**

<b>1</b>	<b>General Description</b> .....	<b>1</b>	17.5	Overcurrent Protection .....	12
<b>2</b>	<b>Features</b> .....	<b>1</b>	17.6	Thermal Shutdown and Over-Temperature Protection .....	12
<b>3</b>	<b>Applications</b> .....	<b>1</b>	<b>18</b>	<b>Application Information</b> .....	<b>14</b>
<b>4</b>	<b>Simplified Application Circuit</b> .....	<b>1</b>	18.1	Dropout Voltage .....	14
<b>5</b>	<b>Ordering Information</b> .....	<b>2</b>	18.2	Input, Output, and Bias Capacitor Selection .....	14
<b>6</b>	<b>Marking Information</b> .....	<b>2</b>	18.3	Adjusting the Output Voltage .....	14
<b>7</b>	<b>Pin Configuration</b> .....	<b>4</b>	18.4	Power Up Sequence Requirement .....	14
<b>8</b>	<b>Functional Pin Description</b> .....	<b>4</b>	18.5	Thermal Consideration .....	15
<b>9</b>	<b>Functional Block Diagram</b> .....	<b>5</b>	18.6	Layout Considerations .....	15
<b>10</b>	<b>Absolute Maximum Ratings</b> .....	<b>6</b>	<b>19</b>	<b>Outline Dimension</b> .....	<b>17</b>
<b>11</b>	<b>ESD Ratings</b> .....	<b>6</b>	<b>20</b>	<b>Footprint Information</b> .....	<b>18</b>
<b>12</b>	<b>Recommended Operating Conditions</b> .....	<b>6</b>	<b>21</b>	<b>Packing Information</b> .....	<b>19</b>
<b>13</b>	<b>Thermal Information</b> .....	<b>6</b>	21.1	Tape and Reel Data .....	19
<b>14</b>	<b>Electrical Characteristics</b> .....	<b>7</b>	21.2	Tape and Reel Packing .....	20
<b>15</b>	<b>Typical Application Circuit</b> .....	<b>9</b>	21.3	Packing Material Anti-ESD Property .....	21
<b>16</b>	<b>Typical Operating Characteristics</b> .....	<b>10</b>	<b>22</b>	<b>Datasheet Revision History</b> .....	<b>22</b>
<b>17</b>	<b>Operation</b> .....	<b>12</b>			
	17.1 VIN and VBIAS Supply .....	12			
	17.2 Enable and Shutdown .....	12			
	17.3 Soft-Start .....	12			
	17.4 Power GOOD .....	12			

## 7 Pin Configuration

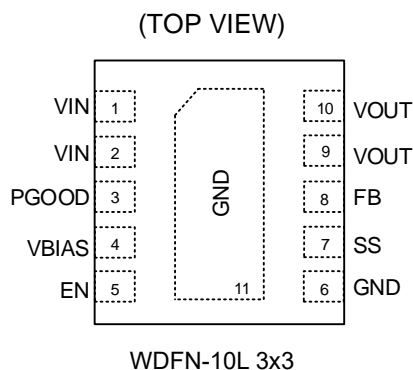

## 8 Functional Pin Description

Pin No.	Pin Name	Pin Function
1, 2	VIN	Power input of the device.
9, 10	VOUT	Regulated output voltage. A minimum of 2.2 $\mu$ F capacitor should be placed directly at this pin.
3	PGOOD	Power good indicator. An open-drain, active-high output that indicates the status of VOUT. A pull-up resistor from 10k $\Omega$ to 1M $\Omega$ should be connected from this pin to a supply of up to 5.5V.
4	VBIAS	Bias input pin. Providing input voltage for internal control circuitry.
5	EN	Chip enable (Active-High). Pulling this pin below 0.4V turns the regulator off, reducing the quiescent current to a fraction of its operating value. Connect to VIN if not being used.
6, 11 (Exposed Pad)	GND	Ground. The Exposed Pad must be soldered to a large PCB and connected to GND for maximum power dissipation.
7	SS	Connect a capacitor between this pin and the ground to set the soft-start ramp time of the output voltage.
8	FB	Feedback pin. Connect this pin to an external voltage divider to set the output voltage.

**9 Functional Block Diagram**

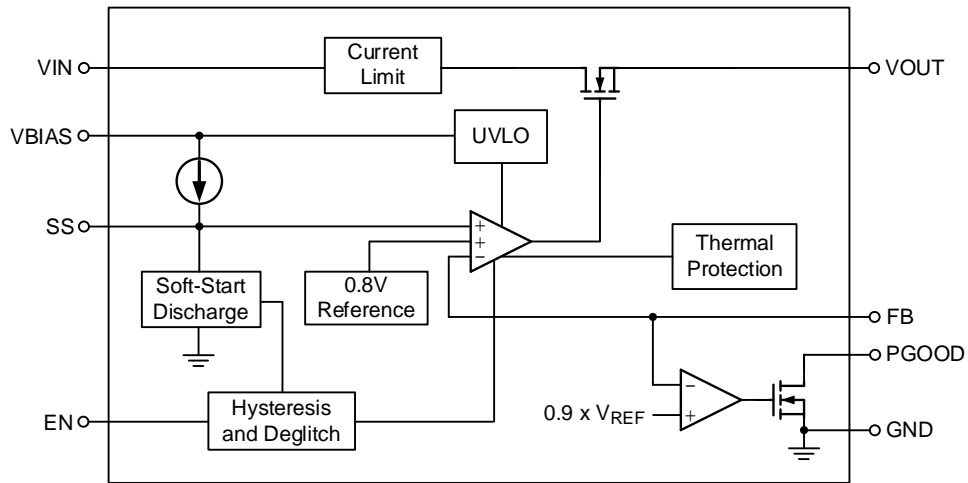

## 10 Absolute Maximum Ratings

(Note 1)

- Supply Input Voltage, VIN ----- -0.3V to 6V
- Other Pins ----- -0.3V to 6V
- Output Voltage, VOUT ----- -0.3V to 6.3V
- Lead Temperature (Soldering, 10 sec.) ----- 260°C
- Junction Temperature ----- 150°C
- Storage Temperature Range ----- -65°C to 150°C

**Note 1.** Stresses beyond those listed under “Absolute Maximum Ratings” may cause permanent damage to the device. These are stress ratings only, and functional operation of the device at these or any other conditions beyond those indicated in the operational sections of the specifications is not implied. Exposure to absolute maximum rating conditions may affect device reliability.

## 11 ESD Ratings

(Note 2)

- ESD Susceptibility  
HBM (Human Body Model) ----- 2kV

**Note 2.** Devices are ESD sensitive. Handling precautions are recommended.

## 12 Recommended Operating Conditions

(Note 3)

- Supply Input Voltage, VIN ----- 0.8V to 5.5V
- Junction Temperature Range ----- -40°C to 125°C

**Note 3.** The device is not guaranteed to function outside its operating conditions.

## 13 Thermal Information

(Note 4 and Note 5)

Thermal Parameter		WDFN-10L 3x3	Unit
$\theta_{JA}$	Junction-to-ambient thermal resistance (JEDEC standard)	40.4	°C/W
$\theta_{JC(Top)}$	Junction-to-case (top) thermal resistance	70.4	°C/W
$\theta_{JC(Bottom)}$	Junction-to-case (bottom) thermal resistance	13.6	°C/W
$\theta_{JA(EVB)}$	Junction-to-ambient thermal resistance (specific EVB)	41.5	°C/W
$\Psi_{JC(Top)}$	Junction-to-top characterization parameter	1.5	°C/W
$\Psi_{JB}$	Junction-to-board characterization parameter	25.2	°C/W

**Note 4.** For more information about thermal parameter, see the Application and Definition of Thermal Resistances report, [AN061](#).

**Note 5.**  $\theta_{JA(EVB)}$ ,  $\Psi_{JC(TOP)}$  and  $\Psi_{JB}$  are measured on a high effective-thermal-conductivity four-layer test board which is in size of 70mm x 50mm; furthermore, all layers with 1 oz. Cu. Thermal resistance/parameter values may vary depending on the PCB material, layout, and test environmental conditions.

**14 Electrical Characteristics**

( $V_{EN} = 1.1V$ ,  $V_{IN} = V_{OUT} + 0.3V$ ,  $V_{BIAS} = 5V$ ,  $C_{BIAS} = 0.1\mu F$ ,  $C_{IN} = C_{OUT} = 10\mu F$ ,  $C_{SS} = 1nF$ ,  $I_{OUT} = 50mA$ ,  $T_J = -40^{\circ}C$  to  $125^{\circ}C$ , otherwise specified. Typical values are at  $T_A = 25^{\circ}C$ ).

Parameter	Symbol	Test Conditions	Min	Typ	Max	Unit
Input Voltage	$V_{IN}$		$V_{OUT} + V_{DROP}$	--	5.5	V
VBIAS Pin Voltage	$V_{BIAS}$		2.7	--	5.5	V
Internal Reference	$V_{REF}$	$T_A = 25^{\circ}C$	0.796	0.8	0.804	V
Output Voltage Range	$V_{OUT}$	$V_{IN} = 5V$ , $I_{OUT} = 1A$	$V_{REF}$	--	3.6	V
Accuracy		$2.97V \leq V_{BIAS} \leq 5.5V$ , $50mA \leq I_{OUT} \leq 1A$	-1	$\pm 0.5$	1	%
Line Regulation	$V_{LINE\_REG}$	$V_{OUT} (Normal) + 0.3 \leq V_{IN} \leq 5.5V$	--	0.03	--	%/V
Load regulation	$V_{LOAD\_REG}$	$50mA \leq I_{OUT} \leq 1A$	--	0.09	--	%/A
$V_{IN}$ Dropout Voltage	$V_{DROP\_VIN}$	$I_{OUT} = 1A$ , $V_{BIAS} - V_{OUT} (Normal) \geq 3.25V$	--	50	--	mV
VBIAS Dropout Voltage	$V_{DROP\_VBIAS}$	$I_{OUT} = 1A$ , $V_{IN} = V_{BIAS}$	--	--	1.2	V
		$I_{OUT} = 0.5A$ , $V_{IN} = V_{BIAS}$	--	--	1.1	V
Current Limit	$I_{LIM}$	$V_{OUT} = 80\% \times V_{OUT} (Normal)$	--	1.6	--	A
Bias Pin Current	$I_{BIAS}$		--	1	2	mA
Shutdown Supply Current (IGND)	$I_{SHDN}$	$V_{EN} = 0.4V$	--	1	50	$\mu A$
Feedback Pin Current	$I_{FB}$		-1	0.15	1	$\mu A$
Power-Supply Rejection ( $V_{IN}$ to $V_{OUT}$ )	PSRR ( <a href="#">Note 6</a> )	1kHz, $I_{OUT} = 0.5A$ , $V_{IN} = 1.8V$ , $V_{OUT} = 1.5V$	--	75	--	dB
		300kHz, $I_{OUT} = 0.5A$ , $V_{IN} = 1.8V$ , $V_{OUT} = 1.5V$	--	30	--	
Power-Supply Rejection ( $V_{BIAS}$ to $V_{OUT}$ )	PSRR ( <a href="#">Note 6</a> )	1kHz, $I_{OUT} = 0.5A$ , $V_{IN} = 1.8V$ , $V_{OUT} = 1.5V$	--	90	--	dB
		300kHz, $I_{OUT} = 0.5A$ , $V_{IN} = 1.8V$ , $V_{OUT} = 1.5V$	--	40	--	
Output Noise Voltage	Noise ( <a href="#">Note 6</a> )	100Hz to 100kHz, $I_{OUT} = 0.5A$ , $C_{SS} = 1nF$	--	$25 \times V_{OUT}$	--	$\mu V_{RMS}$
Minimum Startup Time	$t_{STR}$ ( <a href="#">Note 6</a> )	$R_{LOAD}$ for $I_{OUT} = 1A$ , $C_{SS} = open$	--	200	--	$\mu s$
Soft-Start Charging Current	$I_{SS}$	$V_{SS} = 0.4V$	--	440	--	$\mu A$
Enable Input Voltage	Logic_High	$V_{IH}$	1.1	--	5.5	V
	Logic_Low	$V_{IL}$	0	--	0.4	
Enable Pin Hysteresis	$V_{EN\_HYS}$		--	50	--	mV
Enable Pin Deglitch Time	$V_{EN\_DG}$		--	20	--	$\mu s$
Enable Pin Current	$I_{EN}$	$V_{EN} = 5V$	--	0.1	1	$\mu A$
PGOOD Trip Threshold	$V_{IT}$	$V_{OUT}$ decreasing	85	90	94	% $V_{OUT}$
PGOOD Trip Hysteresis	$V_{HYS}$		--	3	--	% $V_{OUT}$

Parameter	Symbol	Test Conditions	Min	Typ	Max	Unit
PGOOD Output Low Voltage	V <sub>PGOOD_L</sub>	I <sub>PGOOD</sub> = 1mA(sinking), V <sub>OUT</sub> < V <sub>IT</sub>	--	--	0.3	V
PGOOD Leakage Current	V <sub>PGOOD_LK</sub>	V <sub>PGOOD</sub> = 5.25V, V <sub>OUT</sub> > V <sub>IT</sub>	--	0.1	1	μA
Thermal Shutdown Temperature	T <sub>SD</sub>	Shutdown, temperature increasing	--	165	--	°C
		Reset, temperature decreasing	--	140	--	

**Note 6.** Guaranteed by design.



**15 Typical Application Circuit**

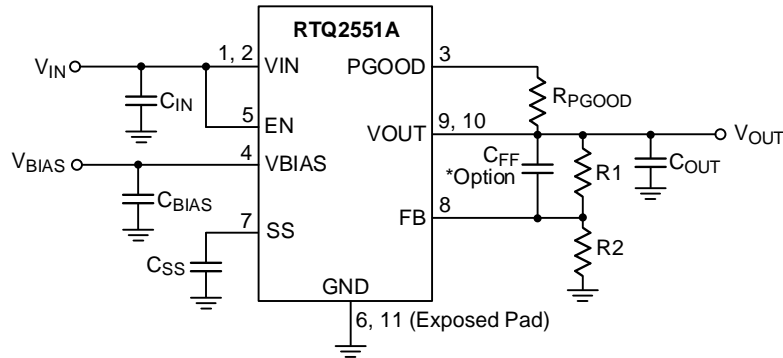

\*: The feedforward capacitor is optional for the transient response and circuit stability improvement.

**Table 1. Suggested Component Value**

Vout(V)	R1 (kΩ)	R2 (kΩ)
0.8	Short	Open
0.9	0.619	4.99
1.0	1.13	4.52
1.05	1.37	4.42
1.1	1.87	4.99
1.2	2.49	4.99
1.5	4.12	4.75
1.8	3.57	2.87
2.5	3.57	1.69
3.3	3.57	1.15

**Table 2. Recommended External Components**

Component	Description	Vendor P/N
CIN, *COUT	10μF, 16V, X7S, 0805	GCM21BC71C106KE36 (Murata)
CSS	1nF, 50V, X7R, 0603	GCD188R71H102KA01 (Murata)
CBIAS	0.1μF, 50V, X7R, 0603	GCJ188R71H104KA12 (Murata)

\*: Considering the effective capacitance derated with biased voltage level, the COUT component needs satisfy the effective capacitance at least 2.2μF or above at targeted output level for stable and normal operation.

16 Typical Operating Characteristics

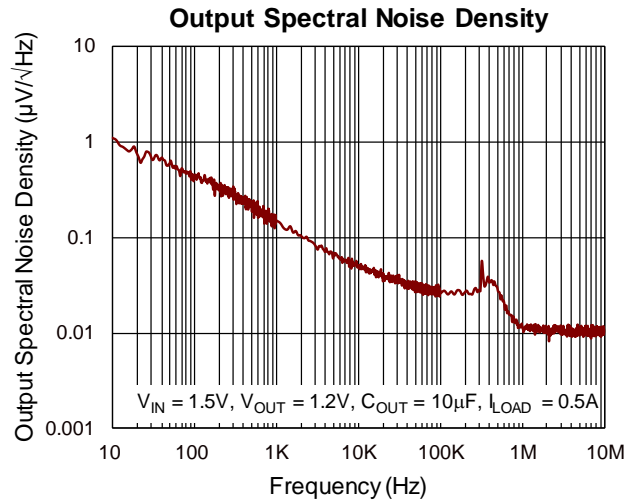
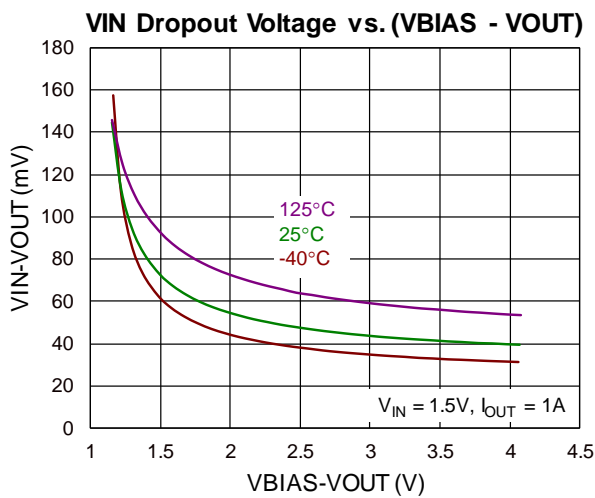
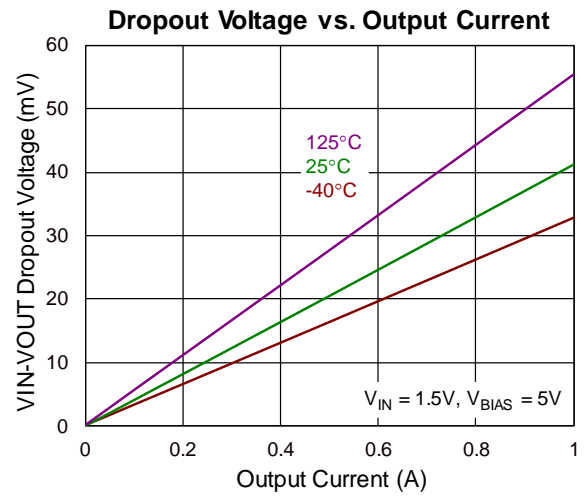
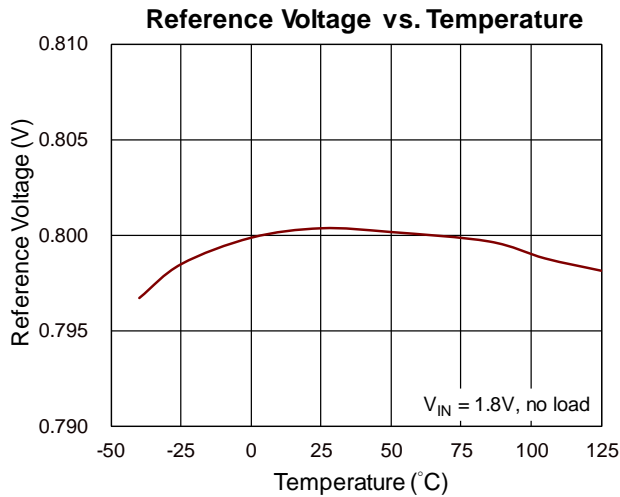
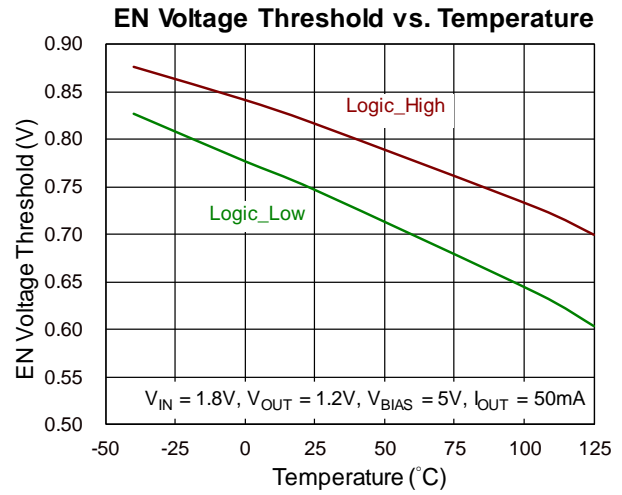
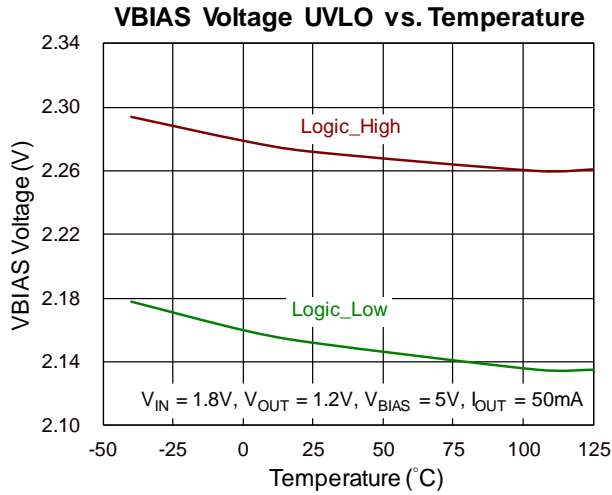

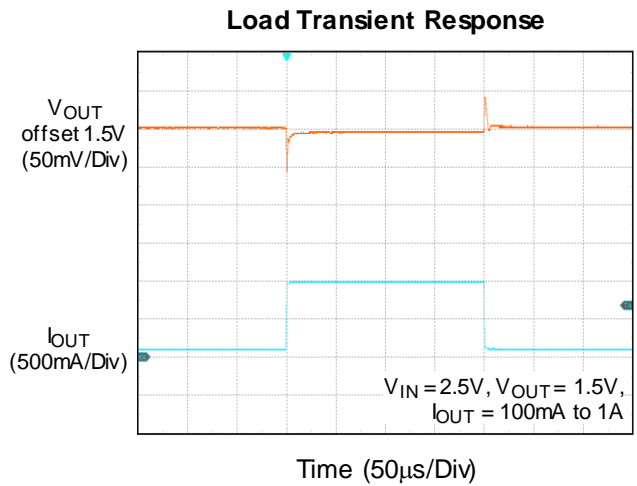
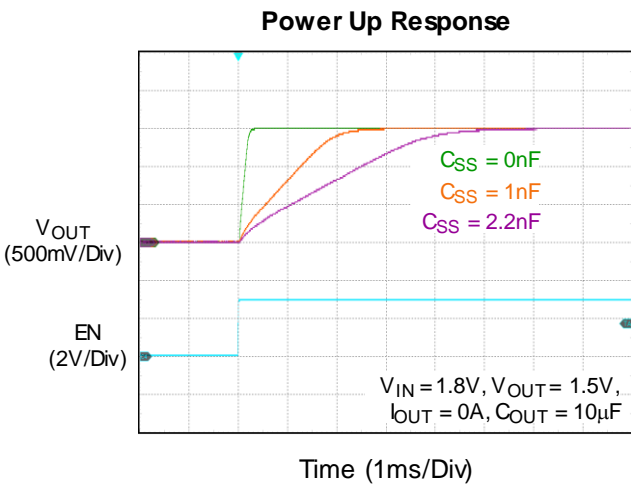
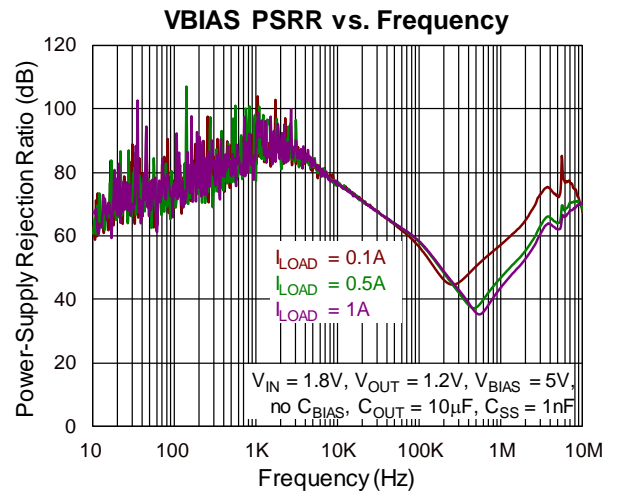
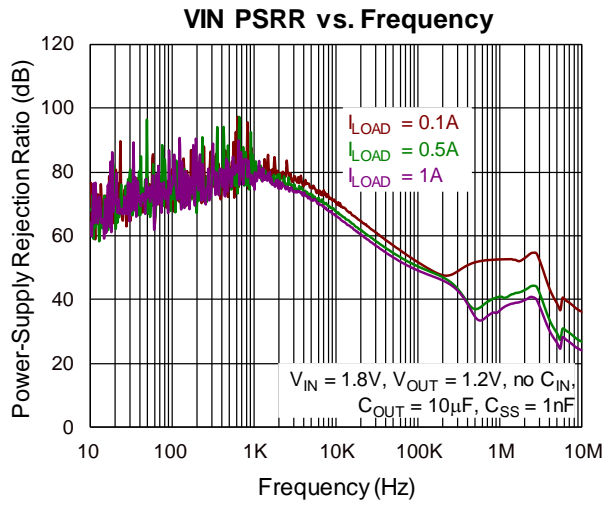

## 17 Operation

The RTQ2551A is a very low dropout linear regulator which operates from input voltage as low as 0.8V. It provides a highly accurate output that is capable of supplying 1A of output current with a typical dropout voltage of only 50mV. Output voltage range is from 0.8V to 3.6V.

### 17.1 VIN and VBIAS Supply

The VBIAS input supplies the internal reference and LDO circuitry while all output current comes directly from the VIN input for high efficiency regulation. With external VBIAS 3.25V above VOUT, offers the RTQ2551A very low dropout performance which allows the device to be used in place of a DC-DC converter and still achieve good efficiency. This provides designers to achieve the smallest, simplest, and lowest cost solution.

For applications where an auxiliary bias voltage is not available or low dropout is not required. In these applications, VBIAS is suggested to be 1.2V above VOUT and attention on power rating and thermal is needed.

### 17.2 Enable and Shutdown

The EN pin is active high. Apply a voltage above 1.1V ensures the LDO regulator turns on, while the regulator turns off if the VEN belows 0.4V. The enable circuitry has typical 50mV hysteresis and deglitching for use with relatively slowly ramping analog signals. That helps avoid on-off cycling as a result of small glitches in the VEN signal. A fast rise-time signal must be used to enable the RTQ2551A if precise turn-on timing is required. If not used, EN can be connected to either VIN or VBIAS. If EN is connected to VIN, it should be connected as close as possible to the largest capacitance on the input to prevent voltage droops on that line from triggering the enable circuit.

### 17.3 Soft-Start

The RTQ2551A includes a soft-start feature to prevent excessive current flow during start-up. When the LDO is enabled, an internal soft-start current (Iss) charges the external soft-start capacitor (C<sub>SS</sub>) to build a ramp-up voltage internally. The RTQ2551A achieve a linear and monotonic soft-start by tracking the voltage ramp until the voltage exceeds the internal reference. The soft-start ramp time can be calculated using Equation 1:

$$t_{SS}(S) = \frac{V_{REF} \times C_{SS}}{I_{SS}} = \frac{0.8V \times C_{SS}(F)}{0.44\mu A} \quad (1)$$

### 17.4 Power GOOD

When the output voltage is greater than V<sub>IT</sub> + V<sub>HYS</sub>, the output voltage is considered good and the open-drain PGOOD pin goes high impedance and is typically pulled high with external resistor. If V<sub>OUT</sub> drops below V<sub>IT</sub> or if V<sub>BIAS</sub> drops below 1.9 V, the open-drain output turns on and pulls the PGOOD output low. The PGOOD pin also asserts when the device is disabled, OCP or OTP triggered.

### 17.5 Overcurrent Protection

The RTQ2551A has built-in overcurrent protection. When overcurrent (typ. 1.6A) is detected, the RTQ2551A foldback and limit the current at typical 1.2A. It allows the device to supply surges of up to 1.6A and prevent the device over-heating if short circuit happened.

### 17.6 Thermal Shutdown and Over-Temperature Protection

The RTQ2551A includes an over-temperature protection (OTP) circuitry to prevent overheating due to excessive power dissipation, and will shut down the LDO when the junction temperature exceeds approximately 165°C. It

will re enable the LDO once the junction temperature drops back to approximately 140°C. The RTQ2551A will cycle in and out of thermal shutdown without latch-up or damage until the overstress condition is removed. Long term overstress ( $T_J > 125^\circ\text{C}$ ) should be avoided as it can degrade the performance or shorten the life of the part. Note that the over-temperature protection is intended to protect the device during momentary overload conditions. The protection is activated outside of the absolute maximum range of operation as a secondary fail-safe and therefore should not be relied upon operationally. Continuous operation above the specified absolute maximum operating junction temperature may impair device reliability or permanently damage the device.

## 18 Application Information

*Richtek's component specification does not include the following information in the Application Information section. Thereby no warranty is given regarding its validity and accuracy. Customers should take responsibility to verify their own designs and reserve suitable design margin to ensure the functional suitability of their components and systems.*

The RTQ2551A is a low dropout regulator that features soft-start capability. It provides EN and PGOOD for easily system sequence control, and built-in overcurrent & thermal protection for safe operation.

### 18.1 Dropout Voltage

Because of two power supply inputs VIN and VBIAS and one VOUT regulator output, there are two Dropout voltages specified. The first is the VIN Dropout voltage is the voltage difference ( $V_{IN} - V_{OUT}$ ) when VOUT starts to decrease by percent specified in the Electrical Characteristics table.

The second, VBIAS dropout voltage is the voltage difference ( $V_{BIAS} - V_{OUT}$ ) when VIN and VBIAS pins are joined together and VOUT starts to decrease. This option allows the device to be used in applications where an auxiliary bias voltage is not available or low dropout is not required. In these applications, VBIAS is suggested to be 1.2V above VOUT and attention on power rating and thermal is needed.

### 18.2 Input, Output, and Bias Capacitor Selection

The device is designed to be stable for all available types and values of output capacitors  $\geq 2.2\mu\text{F}$ . The device is also stable with multiple capacitors in parallel, which can be of any type or value. The capacitance required on the VIN and VBIAS pins strongly depends on the input supply source impedance. To counteract any inductance in the input, the minimum recommended capacitor for VIN is  $1\mu\text{F}$  and minimum recommended capacitor for VBIAS is  $0.1\mu\text{F}$ . If VIN and VBIAS are connected to the same supply, the recommended minimum capacitor for VBIAS is  $4.7\mu\text{F}$ . Good quality, low ESR capacitors should be used on the input; ceramic X5R and X7R capacitors are preferred. These capacitors should be placed as close the pins as possible for optimum performance.

### 18.3 Adjusting the Output Voltage

The output voltage of the RTQ2551A is adjustable from 0.8V to 3.6V by external voltage divider resistors as shown in Typical Application Circuit. R1 and R2 can be calculated the output voltage. In order to achieve the maximum accuracy specifications, R2 should be  $\leq 4.99\text{k}\Omega$ .

### 18.4 Power Up Sequence Requirement

The RTQ2551A supports power on the input VIN, VBIAS, and EN pins in any order without damage the device. Generally, connecting the EN and VIN for most application is acceptable, as long as VIN and VEN is greater than the EN threshold (typ. = 1.1V) and the input ramp rate of VIN and VBIAS is faster than the output settled soft-start ramp rate. If the VIN/BIAS input source ramp rate is slower than the output settled soft-start time, the output will track the input supply ramp up level and minus the dropout voltage until it reaches the settled output voltage level. For the other case, If EN is connected with VBIAS, and the provided VIN is present before VBIAS, the output soft-start will as programmed. While VBIAS and VEN are present before VIN is applied also the settled soft-start time has expired, then VOUT tracks VIN ramp up. If the soft-start time has not expired, output tracks VIN ramp up until output reaches the value set by the charging soft- start capacitor.

**18.5 Thermal Consideration**

The junction temperature should never exceed the absolute maximum junction temperature  $T_{J(MAX)}$ , listed under Absolute Maximum Ratings, to avoid permanent damage to the device. The maximum allowable power dissipation depends on the thermal resistance of the IC package, the PCB layout, the rate of surrounding airflow, and the difference between the junction and ambient temperatures. The maximum power dissipation can be calculated using the following formula:

$$P_{D(MAX)} = (T_{J(MAX)} - T_A) / \theta_{JA}$$

where  $T_{J(MAX)}$  is the maximum junction temperature,  $T_A$  is the ambient temperature, and  $\theta_{JA}$  is the junction-to-ambient thermal resistance.

For continuous operation, the maximum operating junction temperature indicated under Recommended Operating Conditions is 125°C. The junction-to-ambient thermal resistance,  $\theta_{JA(EVB)}$ , is highly package dependent. For a WDFN-10L 3x3 package, the thermal resistance,  $\theta_{JA(EVB)}$ , is 41.5°C/W on a high effective-thermal-conductivity four-layer test board. The maximum power dissipation at  $T_A = 25^\circ\text{C}$  can be calculated as below:

$$P_{D(MAX)} = (125^\circ\text{C} - 25^\circ\text{C}) / (41.5^\circ\text{C/W}) = 2.41\text{W for a WDFN-10L 3x3 package.}$$

The maximum power dissipation depends on the operating ambient temperature for the fixed  $T_{J(MAX)}$  and the thermal resistance,  $\theta_{JA(EVB)}$ . The derating curve in [Figure 1](#) allows the designer to see the effect of rising ambient temperature on the maximum power dissipation.

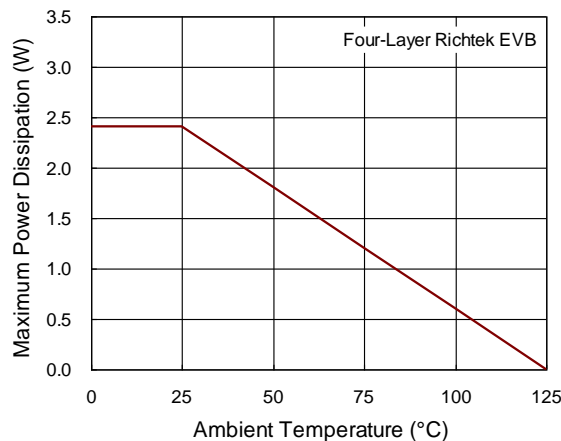

Figure 1. Derating Curve of Maximum Power Dissipation

**18.6 Layout Considerations**

For best performance of the RTQ2551A, the PCB layout suggestions below are highly recommended:

- ▶ Input capacitor must be placed as close as possible to IC to minimize the power loop area.
- ▶ Minimize the power trace length and avoid using vias for the input and output capacitors connection.

[Figure 2](#) shows the example for the layout reference which helps the inductive parasitic components minimization, load transient reduction and good circuit stability.

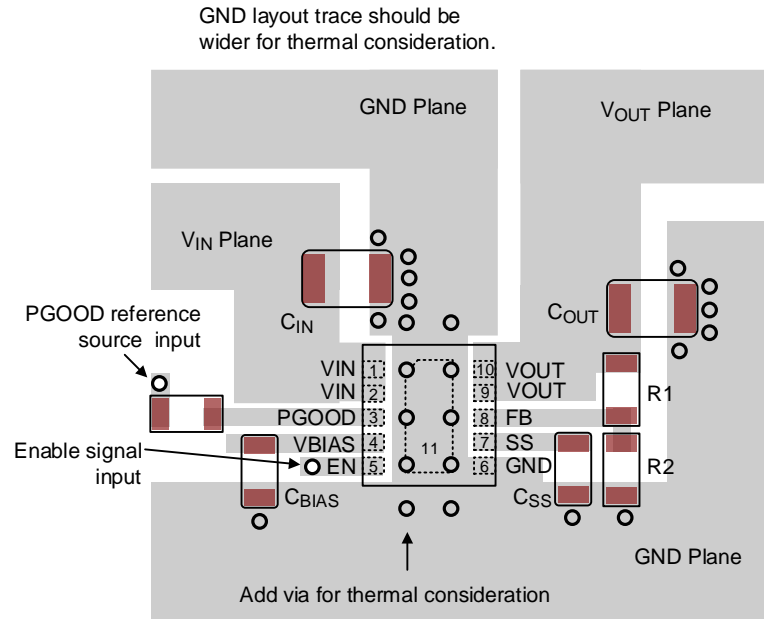
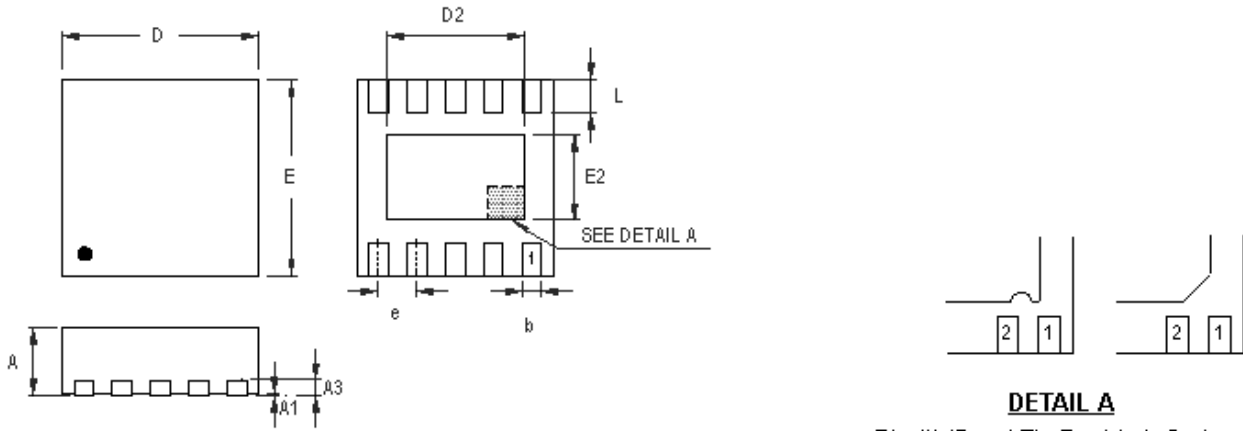

Figure 2. PCB Layout Guide



**19 Outline Dimension**



**DETAIL A**  
Pin #1 ID and Tie Bar Mark Options

Note : The configuration of the Pin #1 identifier is optional, but must be located within the zone indicated.

Symbol	Dimensions In Millimeters		Dimensions In Inches	
	Min	Max	Min	Max
A	0.700	0.800	0.028	0.031
A1	0.000	0.050	0.000	0.002
A3	0.175	0.250	0.007	0.010
b	0.180	0.300	0.007	0.012
D	2.950	3.050	0.116	0.120
D2	2.300	2.650	0.091	0.104
E	2.950	3.050	0.116	0.120
E2	1.500	1.750	0.059	0.069
e	0.500		0.020	
L	0.350	0.450	0.014	0.018

**W-Type 10L DFN 3x3 Package**

## 20 Footprint Information

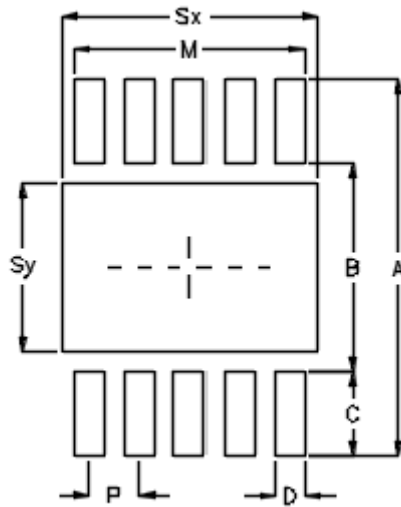

Package	Number of Pin	Footprint Dimension (mm)								Tolerance
		P	A	B	C	D	Sx	Sy	M	
V/W/U/X/ZDFN3*3-10	10	0.50	3.80	2.10	0.85	0.30	2.55	1.70	2.30	±0.05

**21 Packing Information**

**21.1 Tape and Reel Data**

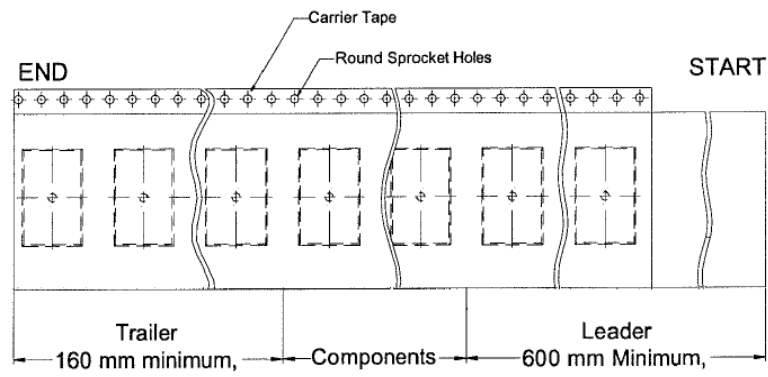
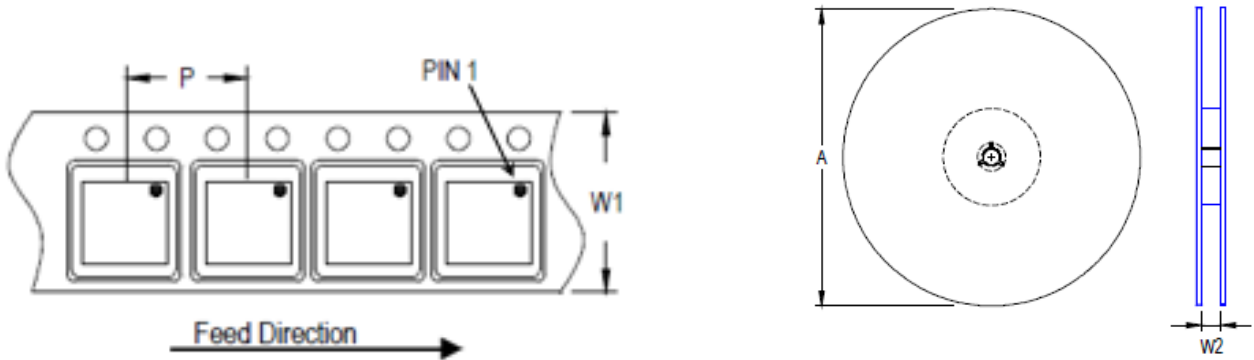



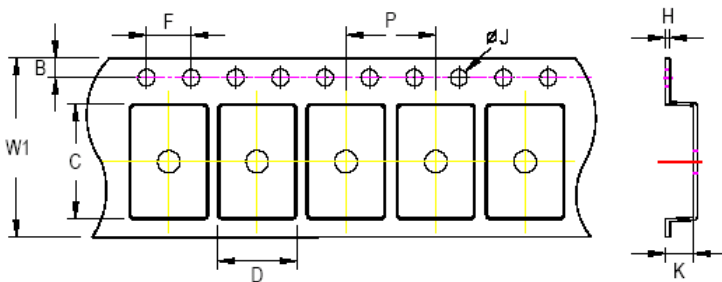



Package Type	Tape Size (W1) (mm)	Pocket Pitch (P) (mm)	Reel Size (A)		Units per Reel	Trailer (mm)	Leader (mm)	Reel Width (W2) Min./Max. (mm)
			(mm)	(in)				
QFN/DFN 3x3	12	8	180	7	1,500	160	600	12.4/14.4



**C, D, and K are determined by component size. The clearance between the components and the cavity is as follows:**  
**- For 12mm carrier tape: 0.5mm max.**

Tape Size	W1		P		B		F		ØJ		H
	Max.	Min.	Max.	Min.	Max.	Min.	Max.	Min.	Max.	Max.	
12mm	12.3mm	7.9mm	8.1mm	1.65mm	1.85mm	3.9mm	4.1mm	1.5mm	1.6mm	0.6mm	

## 21.2 Tape and Reel Packing

Step	Photo/Description	Step	Photo/Description
1	 <p>Reel 7"</p>	4	 <p>3 reels per inner box <b>Box A</b></p>
2	 <p>HIC &amp; Desiccant (1 Unit) inside</p>	5	 <p>12 inner boxes per outer box</p>
3	 <p>Caution label is on backside of Al bag</p>	6	 <p>Outer box <b>Carton A</b></p>

Package	Reel		Box				Carton			
	Size	Units	Item	Size(cm)	Reels	Units	Item	Size(cm)	Boxes	Unit
QFN/DFN 3x3	7"	1,500	Box A	18.3*18.3*8.0	3	4,500	Carton A	38.3*27.2*38.3	12	54,000
			Box E	18.6*18.6*3.5	1	1,500	For Combined or Partial Reel.			

**21.3 Packing Material Anti-ESD Property**

Surface Resistance	Aluminum Bag	Reel	Cover tape	Carrier tape	Tube	Protection Band
$\Omega/\text{cm}^2$	$10^4$ to $10^{11}$	$10^4$ to $10^{11}$	$10^4$ to $10^{11}$	$10^4$ to $10^{11}$	$10^4$ to $10^{11}$	$10^4$ to $10^{11}$

**Richtek Technology Corporation**

14F, No. 8, Tai Yuen 1<sup>st</sup> Street, Chupei City  
 Hsinchu, Taiwan, R.O.C.  
 Tel: (8863)5526789

**RICHTEK**

Richtek products are sold by description only. Richtek reserves the right to change the circuitry and/or specifications without notice at any time. Customers should obtain the latest relevant information and data sheets before placing orders and should verify that such information is current and complete. Richtek cannot assume responsibility for use of any circuitry other than circuitry entirely embodied in a Richtek product. Information furnished by Richtek is believed to be accurate and reliable. However, no responsibility is assumed by Richtek or its subsidiaries for its use; nor for any infringements of patents or other rights of third parties which may result from its use. No license is granted by implication or otherwise under any patent or patent rights of Richtek or its subsidiaries.

Copyright © 2024 Richtek Technology Corporation. All rights reserved. **RICHTEK** is a registered trademark of Richtek Technology Corporation.

**22 Datasheet Revision History**

Version	Date	Description	Item
00	2023/12/6	Final	Electrical Characteristics on P7 Operation on P12
01	2024/3/8	Modify	General Description on P1 Features on P1 Electrical Characteristics on P7 Operation on P12, 13 Application Information on P14