

36V_{IN}, 3A, High Efficiency Synchronous Step-Down Converter Evaluation Board

General Description

The RTQ2105GQWT-QA evaluation board showcases the regulator's performance, delivering 3A output from a 3V to 36V input at 2.1MHz. Suitable for industrial and communication systems, it offers protection against shorted outputs, input undervoltage, overcurrent, and thermal shutdown. The documentation includes a BOM, typical application, board overview, power-up procedure, performance summary, and hardware description to provide information on the board's components, capabilities, and usage.

Table of Contents

General Description	1
Performance Specification Summary	2
Power-up Procedure	2
Detailed Description of Hardware	3
Bill of Materials.....	5
Typical Applications	6
Evaluation Board Layout.....	9
More Information.....	11
Important Notice for Richtek Evaluation Board.....	11

Performance Specification Summary

Summary of the RTQ2105 Evaluation Board performance specification is provided in Table 1. The ambient temperature is 25°C.

Table 1. RTQ2105 Evaluation Board Performance Specification Summary

Specification	Test Conditions	Min	Typ	Max	Unit
Input Voltage Range	$V_{OUT} = 5V$	7	--	25	V
Output Current		0	--	3	A
Default Output Voltage		--	5	--	V
Operation Frequency		--	2100	--	kHz
Output Ripple Voltage	$I_{OUT} = 3A$	--	10	--	mVp-p
Line Regulation	$I_{OUT} = 3A, V_{IN} = 7V \text{ to } 25V$	--	± 1	--	%
Load Regulation	$V_{IN} = 12V, I_{OUT} = 0.001 \text{ A to } 3A$	--	± 1	--	%
Load Transient Response	$I_{OUT} = 1.5A \text{ to } 3A$	--	± 5	--	%
Maximum Efficiency	$V_{IN} = 12V, V_{OUT} = 5V, I_{OUT} = 3A$	--	94.3	--	%

Power-up Procedure

Suggestion Required Equipments

- RTQ2105 Evaluation Board
- DC power supply capable of at least 36V and 3A
- Electronic load capable of 3A
- Function Generator
- Oscilloscope

Quick Start Procedures

The Evaluation Board is fully assembled and tested. Follow the steps below to verify board operation. Do not turn on supplies until all connections are made. When measuring the output voltage ripple, care must be taken to avoid a long ground lead on the oscilloscope probe. Measure the output voltage ripple by touching the probe tip and ground ring directly across the last output capacitor.

Proper measurement equipment setup and follow the procedure below.

- 1) With power off, connect the input power supply to VIN and GND pins.
- 2) With power off, connect the electronic load between the VOUT and nearest GND pins.
- 3) Turn on the power supply at the input. Make sure that the input voltage does not exceeds 36V on the Evaluation Board.
- 4) Check for the proper output voltage using a voltmeter.
- 5) Once the proper output voltage is established, adjust the load within the operating ranges and observe the output voltage regulation, ripple voltage, efficiency and other performance.

Detailed Description of Hardware

Headers Description and Placement

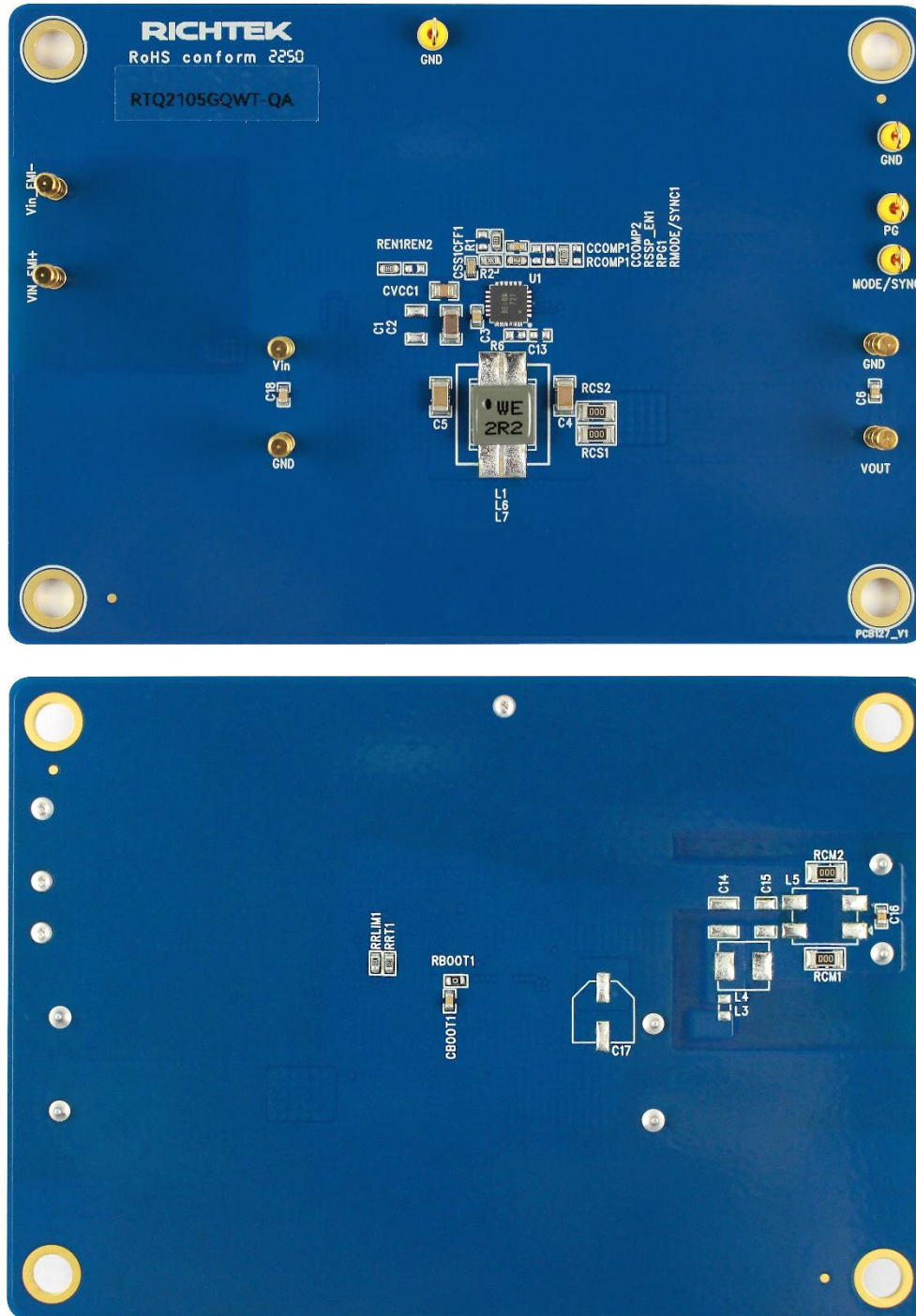

Carefully inspect all the components used in the EVB according to the following Bill of Materials table, and then make sure all the components are undamaged and correctly installed. If there is any missing or damaged component, which may occur during transportation, please contact our distributors or e-mail us at evb_service@richtek.com.

Test Points

The EVB is provided with the test points and pin names listed in the table below.

Test Point/ Pin Name	Function
VIN	Input voltage positive connection. The power supply must be connected to input connectors, VIN and GND.
VOUT	Output voltage connection. The load must be connected to output connectors, VOUT and GND.
GND	Ground. Input/Output voltage return connection.
EN	Enable test point. The test point can be used to measure the enable signal.
J9	EN jumper. Connect EN to ground to disable, connect EN to logic high to enable.
SW	Switch node test point. The test point can be used to measure the switching node.
PG	Power-good indication test point. The test point can be used to measure the power-good signal.
SS	Soft-start test point.
SSP_EN	Spread spectrum enable input. Connect this pin to VCC to enable spread spectrum. Float this pin or connect it to Ground to disable spread spectrum.
MODE_SYNC	Mode selection and external synchronous signal input. Ground this pin or leave this pin floating enables the power saving mode operation at light load. Apply a DC voltage of 2V or higher or tie to VCC for FPWM mode operation. Tie to a clock source for synchronization to an external frequency.
VCC_EXT	Linear regulator output test point. The test point can be used to measure the output node of the internal regulator.

Bill of Materials

V _{IN} = 12V, V _{OUT} = 5V, I _{OUT} = 3A, f _{sw} = 2100kHz						
Reference	Count	Part Number	Value	Description	Package	Manufacturer
U1	1	RTQ2105GQWT-QA	RTQ2105	Step-Down Converter	WET-WQFN-24SL 4x4	RICHTEK
CBOOT1	1	0603B104K500CT	0.1μF	Capacitor, Ceramic, 50V, X7R	0603	WALSIN
CFF	1	GCM1885C1H100JA16	10pF	Capacitor, Ceramic, 50V, C0G	0603	MURATA
CSS1	1	0603B103K500CT	10nF	Capacitor, Ceramic, 50V, X7R	0603	WALSIN
CVCC1	1	GRM21BR71A106KE51L	10μF	Capacitor, Ceramic, 10V, X7R	0805	MURATA
CCOMP1	1	0603B472K500CT	4.7nF	Capacitor, Ceramic, 50V, X7R	0603	WALSIN
C2	1	GRM31CR71H475KA12L	4.7μF	Capacitor, Ceramic, 50V, X7R	1206	MURATA
C3, C6, C16, C18	4	0603B104K500CT	0.1μF	Capacitor, Ceramic, 50V, X7R	0603	WALSIN
C4, C5	2	GRM31CR71A226KE15L	22μF	Capacitor, Ceramic, 10V, X7R	1206	MURATA
C8	1	GCJ188R71E105MA01	1μF	Capacitor, Ceramic, 25V, X7R	0603	MURATA
RBOOT1	1	WR06X000PTL	0	Resistor, Chip, 1/10W, 1%	0603	WALSIN
RCM1, RCM2, RCS1, RCS2	4	WR12X000 PTL	0	Resistor, Chip, 1/8W, 5%	1206	WALSIN
RPG1, REN1	2	WR06X1003FTL	100k	Resistor, Chip, 1/10W, 1%	0603	WALSIN
RRLIM1	1	WR06X3302FTL	33k	Resistor, Chip, 1/10W, 1%	0603	WALSIN
RRT1	1	WR06X2202FTL	22k	Resistor, Chip, 1/10W, 1%	0603	WALSIN
RCOMP1	1	WR06X7681FTL	7.68k	Resistor, Chip, 1/10W, 1%	0603	WALSIN
R1	1	WR06X1053FTL	105k	Resistor, Chip, 1/10W, 1%	0603	WALSIN
R2	1	WR06X2002FTL	20k	Resistor, Chip, 1/10W, 1%	0603	WALSIN
L1	1	78439344022	2.2μH	Inductor, Isat = 7.5A, 11mΩ		Würth Elektronik

Typical Applications

EVB Schematic Diagram

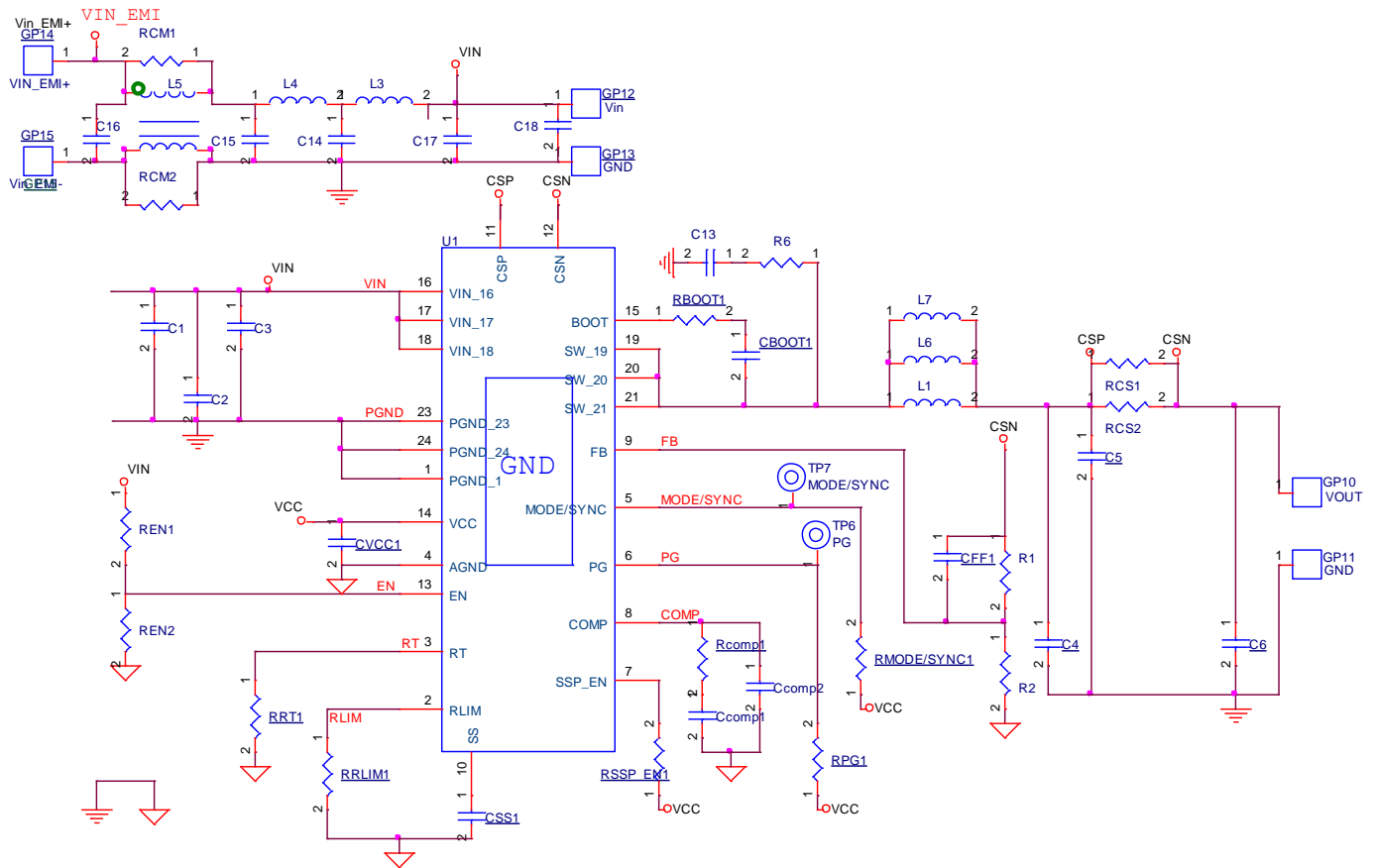

1. The capacitance values of the input and output capacitors will influence the input and output voltage ripple.
2. MLCC capacitors have degrading capacitance at DC bias voltage, and especially smaller size MLCC capacitors will have much lower capacitance.

Measure Result

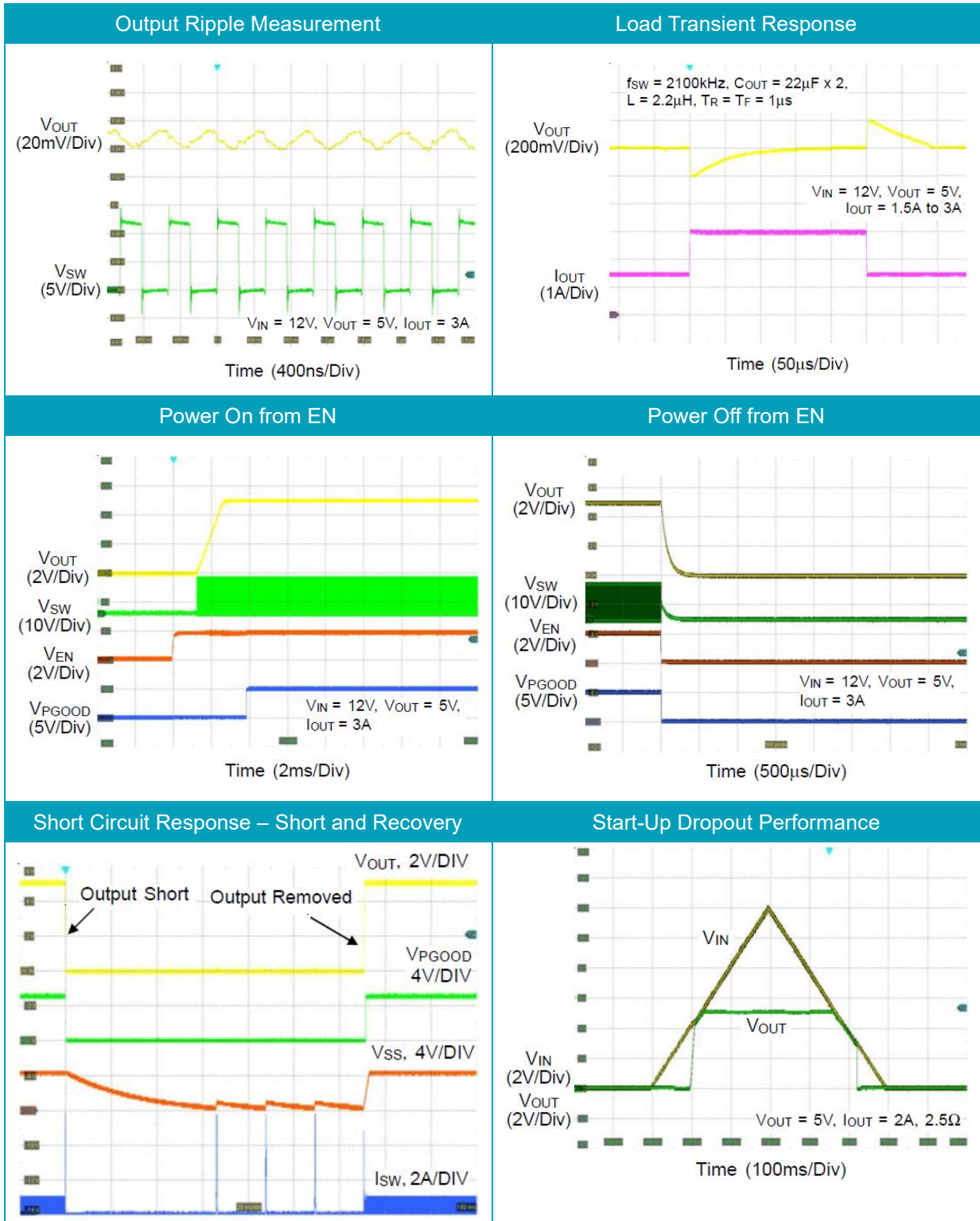

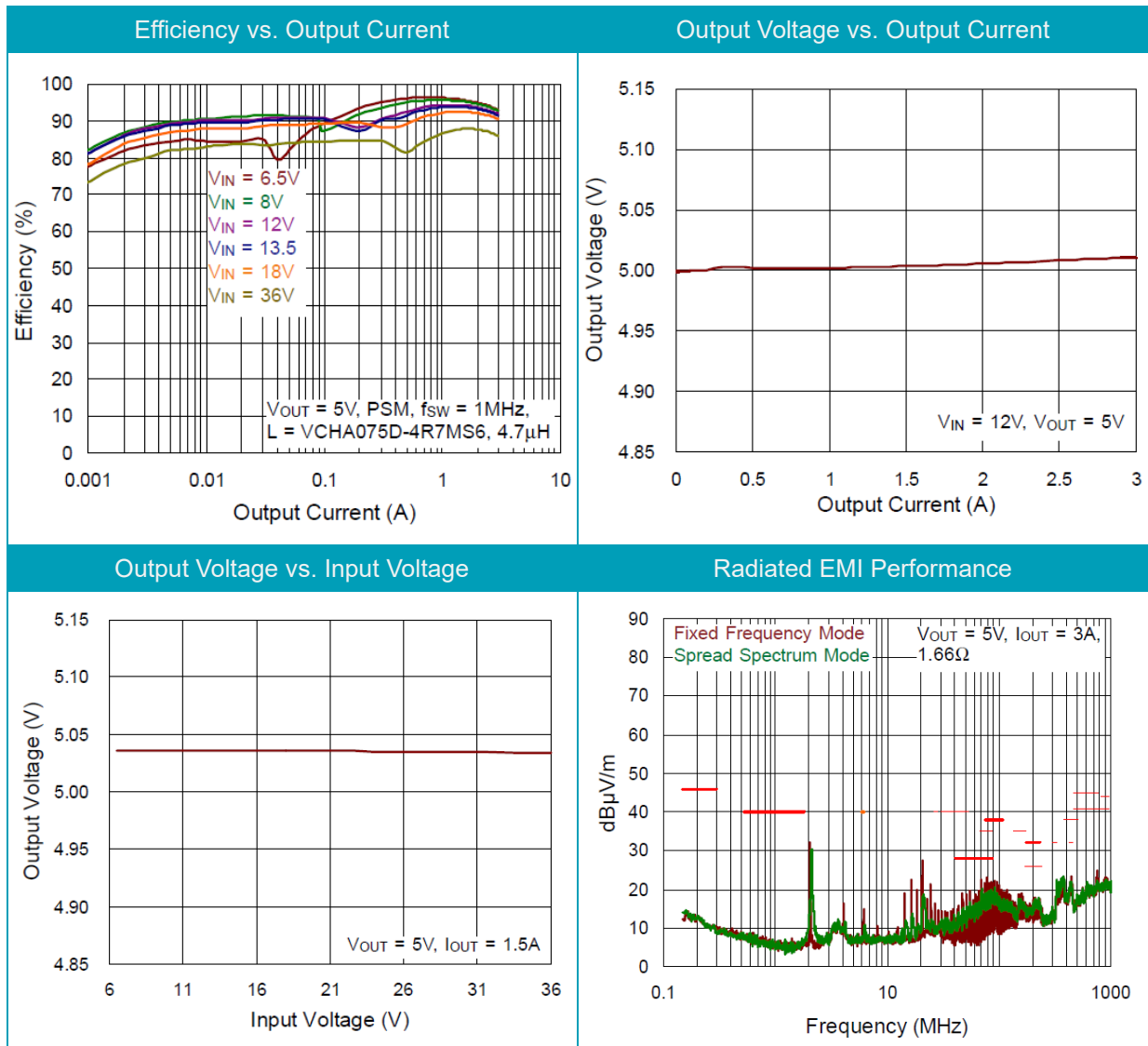

Note: When measuring the input or output voltage ripple, care must be taken to avoid a long ground lead on the oscilloscope probe. Measure the output voltage ripple by touching the probe tip directly across the output capacitor.

Evaluation Board Layout

Figure 1 to Figure 4 are RTQ2105 Evaluation Board layout. This board size is 70mm x 50mm and is constructed on four-layer PCB, outer layers with 1 oz. Cu and inner layers with 1 oz. Cu.

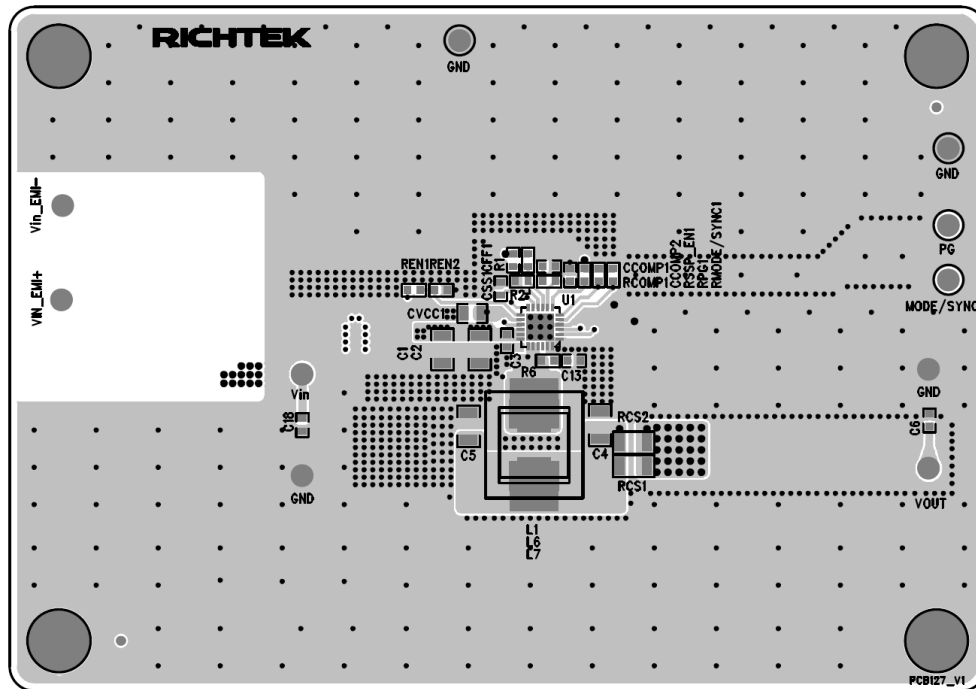

Figure 1. Top View (1st layer)

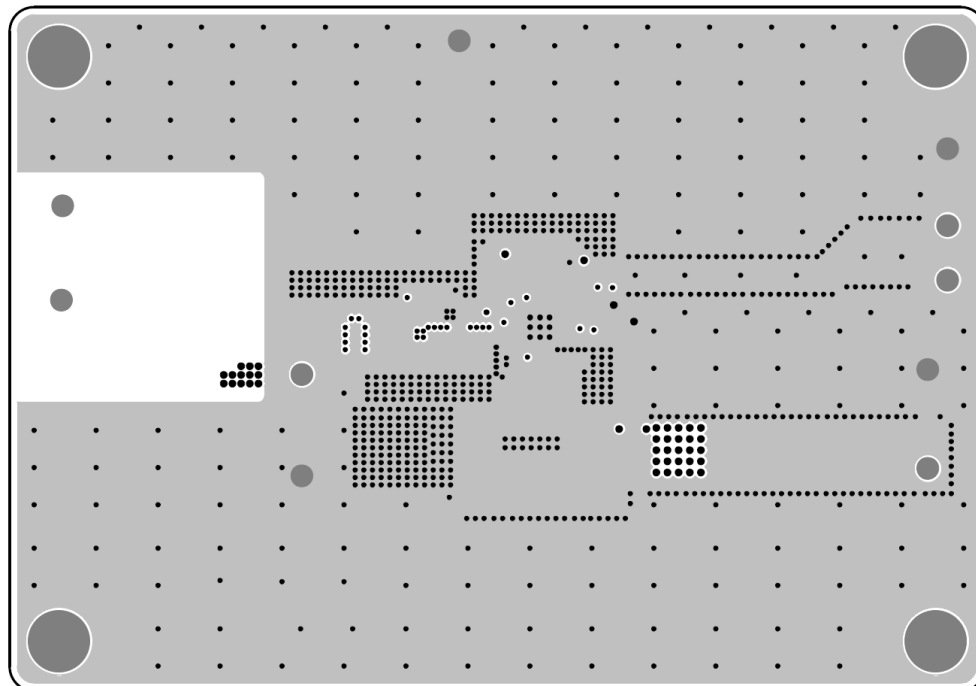

Figure 2. PCB Layout—Inner Side (2nd Layer)

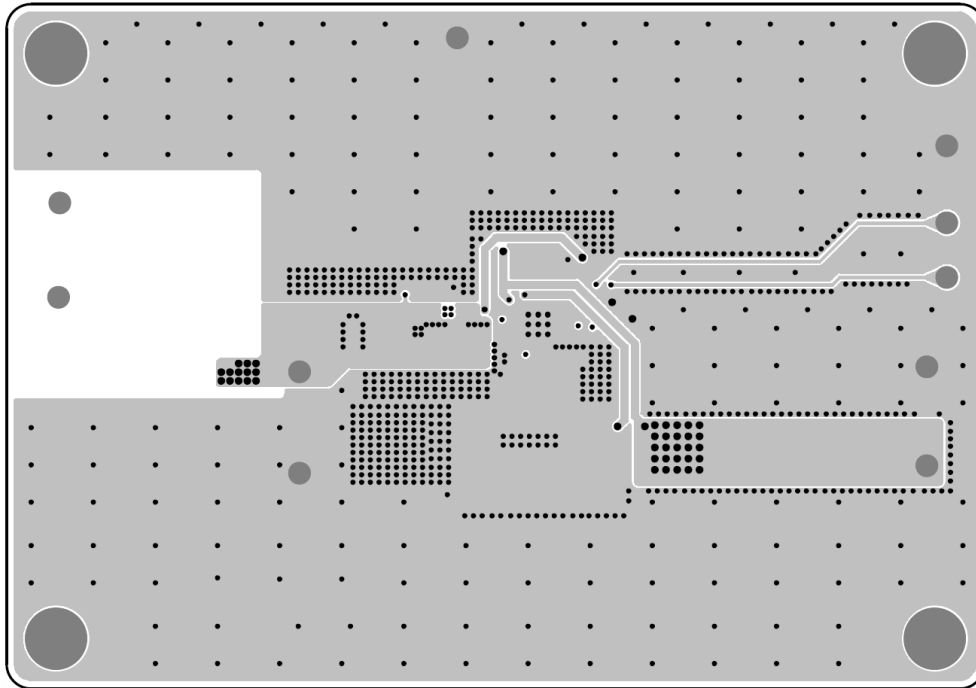

Figure 3. PCB Layout—Inner Side (3rd Layer)

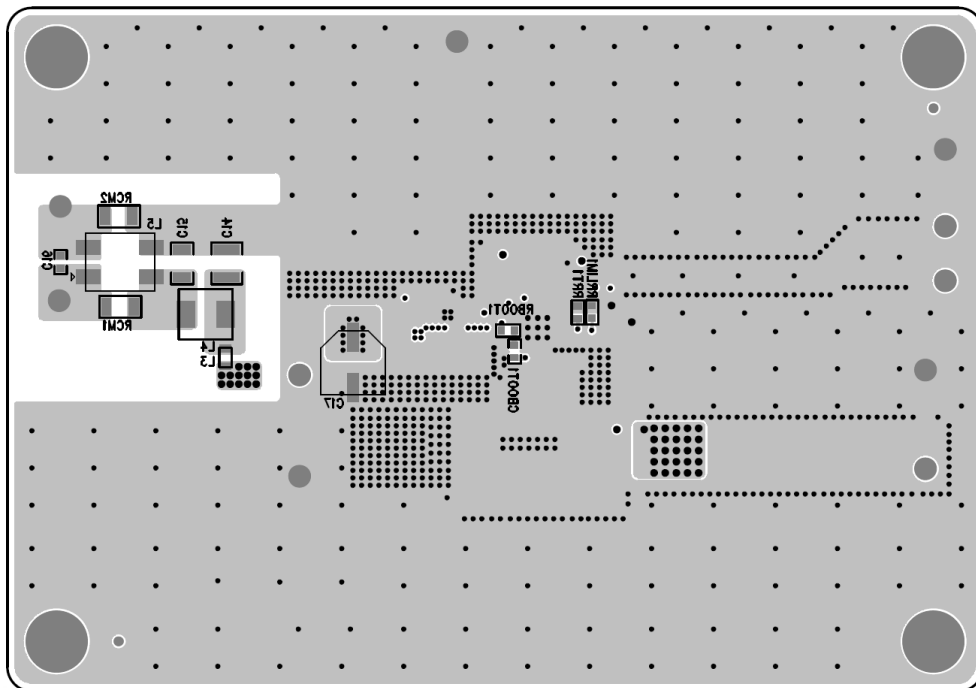

Figure 4. Bottom View (4th Layer)

More Information

For more information, please find the related datasheet or application notes from Richtek website <http://www.richtek.com>.

Important Notice for Richtek Evaluation Board

THIS DOCUMENT IS FOR REFERENCE ONLY, NOTHING CONTAINED IN THIS DOCUMENT SHALL BE CONSTRUED AS RICHTEK'S WARRANTY, EXPRESS OR IMPLIED, UNDER CONTRACT, TORT OR STATUTORY, WITH RESPECT TO THE PRESENTATION HEREIN. IN NO EVENT SHALL RICHTEK BE LIABLE TO BUYER OR USER FOR ANY AND ALL DAMAGES INCLUDING WITHOUT LIMITATION TO DIRECT, INDIRECT, SPECIAL, PUNITIVE OR CONSEQUENTIAL DAMAGES.