

## High Efficiency Boost Converter

### General Description

The RT4812 allows systems to take advantage of new battery chemistries that can supply significant energy when the battery voltage is lower than the required voltage for system power ICs. By combining built-in power transistors, synchronous rectification, and low supply current; this IC provides a compact solution for systems using advanced Li-Ion battery chemistries.

The RT4812 is a boost regulator designed to provide a minimum output voltage from a single-cell Li-Ion battery, even when the battery voltage is below system minimum. In boost mode, output voltage regulation is guaranteed to a maximum load current of 2.1A. Quiescent current in Shutdown Mode is less than 1 $\mu$ A, which maximizes battery life.

### Ordering Information

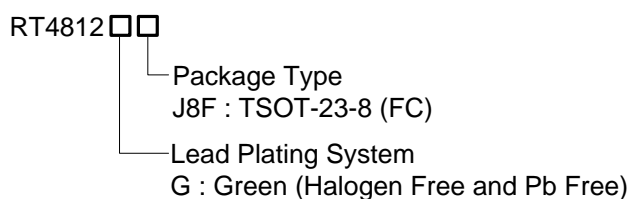

Note :

Richtek products are :

- ▶ RoHS compliant and compatible with the current requirements of IPC/JEDEC J-STD-020.
- ▶ Suitable for use in SnPb or Pb-free soldering processes.

### Features

- CMCOT Topology and Small Output Ripple when VIN close VOUT Voltage
- Operates from a Single Li-ion Cell : 1.8V to 5.5V
- Adjustable Output Voltage : 1.8V to 5.5V
- PSM Operation
- Up to 96% Efficiency
- Boost Current Limit
- Output Over-Voltage Protection
- Pin Adjustable Average Output Current Limit Threshold (2 Levels)
- Internal Compensation
- Output Discharge
- Output Short Protection
- True Load Disconnect

### Applications

- Single-Cell Li-Ion, LiFePO4 Smart-Phones
- Portable Equipment

### Marking Information

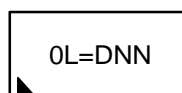

0L = : Product Code  
DNN : Date Code

## Simplified Application Circuit

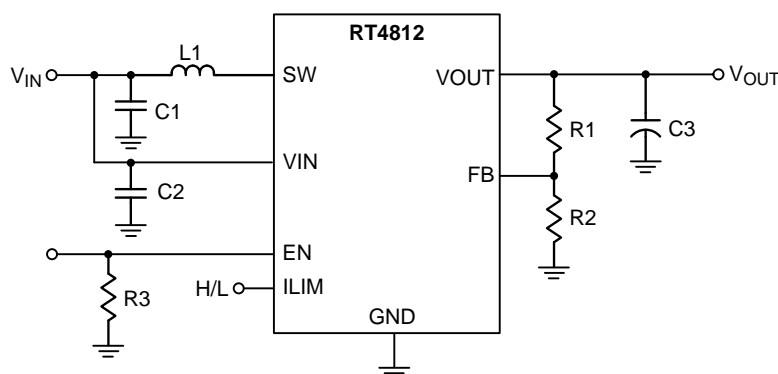

## Pin Configuration

(TOP VIEW)

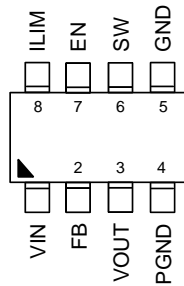

TSOT-23-8 (FC)

## Functional Pin Description

Pin No.	Pin Name	Pin Function
1	VIN	Power input. Input capacitor $C_{IN}$ must be placed as close to IC as possible.
2	FB	Voltage feedback.
3	VOUT	Boost converter output.
4	PGND	Power ground.
5	GND	Analog ground.
6	SW	Switching node.
7	EN	Enable input (1 enabled, 0 disabled), must not be floating.
8	ILIM	Average output current limit control pin. (H/L)

## Functional Block Diagram

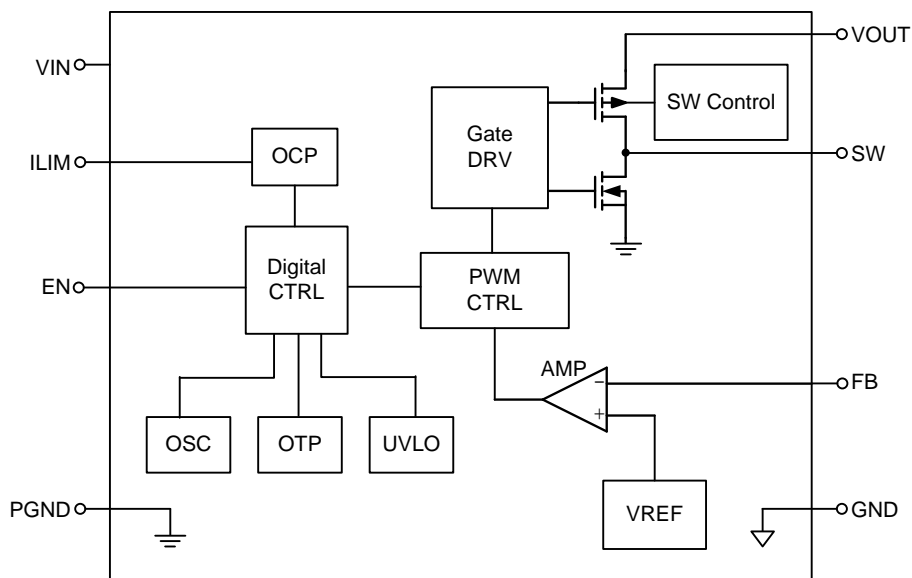

## Operation

The RT4812 combined built-in power transistors, synchronous rectification, and low supply current, it provides a compact solution for system using advanced Li-Ion battery chemistries.

In boost mode, output voltage regulation is guaranteed to a maximum load current of 2.1A. Quiescent current in Shutdown mode is less than 1 $\mu$ A, which maximizes battery life.

Mode	Depiction	Condition
LIN	LIN 1	Linear startup 1
	LIN 2	Linear startup 2
Soft-Start	Boost soft-start	$V_{OUT} < V_{OUT(MIN)}$
Boost	Boost mode	$V_{OUT} = V_{OUT(MIN)}$

### LIN State

When  $V_{IN}$  is rising, it enters the LIN State. There are two parts for the LIN state. It provides maximum current for 1A to charge the  $C_{OUT}$  in LIN1, and the other one is for 3A in LIN2. By the way, the EN is pulled high and  $V_{IN} > UVLO$ .

As the figure shown, if the timeout is over the specification, it will enter the Fault mode.

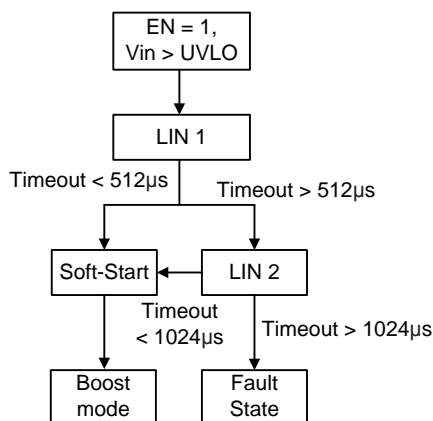

Figure 1. RT4812 State Chart

### Startup and Shutdown State

When  $V_{IN}$  is rising and through the LIN state, it will enter the Startup state. If EN is pulled low, any function is turned-off in shutdown mode.

### Soft-Start State

It starts to switch in Soft-start state. After the LIN state, output voltage is rising with the internal reference voltage.

### Fault State

As the Figure 1 shown, it will enter to the Fault state as below,

- The timeout of LIN2 is over the 1024 $\mu$ s.

It will be the high impedance between the input and output when the fault is triggered. A restart will be start after 20ms.

### OCP

The converter senses the current signal when the high-side P-MOSFET turns on. As a result, the OCP is cycle-by-cycle current limitation. If the OCP occurs, the converter holds off the next on pulse until inductor current drops below the OCP limit.

### OTP

The converter has an over-temperature protection. When the junction temperature is higher than the thermal shutdown rising threshold, the system will be latched and the output voltage will no longer be regulated until the junction temperature drops under the falling threshold.

### Input Voltage POR (Power-On Reset)

The RT4812 is implemented POR function. Power-on reset (POR) function is used to reset IC's status to default. POR function is activated, when  $V_{IN}$  is dropped and it should meet POR requirements. POR function may fail if  $V_{IN}$  pattern are not meet POR event requirement.

POR event requirements are listed below, refer to Figure 2 for the pattern.

1.  $V_{IN\_min} < 0.5V$
2.  $Width > 20\mu s$
3.  $SR\_rising < 1V/\mu s$

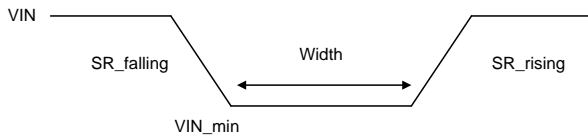

$V_{IN}$  : Input voltage  
 $SR\_falling$  : Slew rate for input voltage drop  
 $SR\_rising$  : Slew rate for input voltage resume  
 $Width$  : Duration of input voltage drop  
 $V_{IN\_min}$  : Minimum voltage

Figure 2. POR Pattern Illustration

**Absolute Maximum Ratings** (Note 1)

- VIN, FB, ILIM, EN, SW to GND----- -0.2V to 6V
- VOUT to GND ----- 6.2V
- Power Dissipation, PD @ TA = 25°C
- TSOT-23-8 (FC)----- 1.78W
- Package Thermal Resistance (Note 2)
- TSOT-23-8 (FC),  $\theta_{JA}$ ----- 56°C/W
- TSOT-23-8 (FC),  $\theta_{JC}$ ----- 28°C/W
- Lead Temperature (Soldering, 10sec.)----- 260°C
- Junction Temperature ----- -65°C to 150°C
- Storage Temperature Range ----- -65°C to 150°C
- ESD Susceptibility (Note 3)
- HBM (Human Body Model) ----- 2kV

**Recommended Operating Conditions** (Note 4)

- Input Voltage Range ----- 1.8V to 5.5V
- Output Voltage Range ----- 1.8V to 5.5V
- Junction Temperature (TJ) Range ----- -40°C to 125°C
- Ambient Temperature (TA) Range ----- -40°C to 85°C

**Electrical Characteristics**

(VIN = 3.6V, TA = 25°C, unless otherwise specified)

Parameter	Symbol	Test Conditions	Min	Typ	Max	Unit
Supply Voltage	VIN	VIN < VOUT – 0.2V	1.8	--	5.5	V
Output Voltage	VOUT	VIN < VOUT – 0.2V	1.8	--	5.5	V
Under-Voltage Lockout Rising Threshold	UVLO_RISE		1.5	1.65	1.8	V
Under-Voltage Lockout Falling Threshold	UVLO_Falling		1.3	1.55	1.7	V
FB Voltage	VFB	Force PWM	0.495	0.5	0.505	V
Regulated DC VOUT Voltage	VOUT	1.8 ≤ VIN ≤ VOUT – 0.2V IOUT = 0mA (PSM)	-2	--	4	%
Shutdown Current	ISHDN	EN = 0V	--	0.1	1	μA
Quiescent Current		Close loop, no load FB = 3V, non-switching current	--	90	--	μA
Pre-charge Current	Ipre		--	1	--	A
Switching Frequency	fsw	VOUT – VIN > 1V	--	0.5	--	MHz
Average Output Current Limit	ILIM	ILIM = L	1	--	--	A
		ILIM = H	2.1	--	--	
High-Side Switch Ron		VIN = 5V	--	45	--	mΩ
Low-Side Switch Ron		VIN = 5V	--	30	--	mΩ

Parameter	Symbol	Test Conditions	Min	Typ	Max	Unit
FB Pin Input Leakage	I <sub>FB</sub>		-1	--	1	μA
Leakage of SW	I <sub>SW</sub>	All switch off	--	--	5	μA
Line Regulation	ΔV <sub>OUT, LINE</sub>	V <sub>IN</sub> = 2.7V to 4.5V, V <sub>OUT</sub> = 5V, I <sub>OUT</sub> = 1500mA	-2	--	2	%
Load Regulation	ΔV <sub>OUT, LOAD</sub>	CCM, I <sub>OUT</sub> < 2A, V <sub>IN</sub> = 3.6V, V <sub>OUT</sub> = 5V	-1.5	--	1.5	%
Output Over Voltage Protection	V <sub>OVP</sub>		5.8	6	6.2	V
EN Input Low Voltage	V <sub>IL</sub>		--	--	0.4	V
EN Input High Voltage	V <sub>IH</sub>		1.2	--	--	V
EN Sink Current			--	0.1	1	μA
Thermal Shutdown	T <sub>SD</sub>		--	160	--	°C
Thermal Shutdown Hysteresis	ΔT <sub>SD</sub>		--	30	--	°C

**Note 1.** Stresses beyond those listed under “Absolute Maximum Ratings” may cause permanent damage to the device. These are stress ratings only, and functional operation of the device at these or any other conditions beyond those indicated in the operational sections of the specifications is not implied. Exposure to absolute maximum rating conditions may affect device reliability.

**Note 2.** θ<sub>JA</sub> is measured at T<sub>A</sub> = 25°C on a two-layer Richtek Evaluation Board.

**Note 3.** Devices are ESD sensitive. Handling precautions are recommended.

**Note 4.** The device is not guaranteed to function outside its operating conditions.

**Typical Application Circuit**

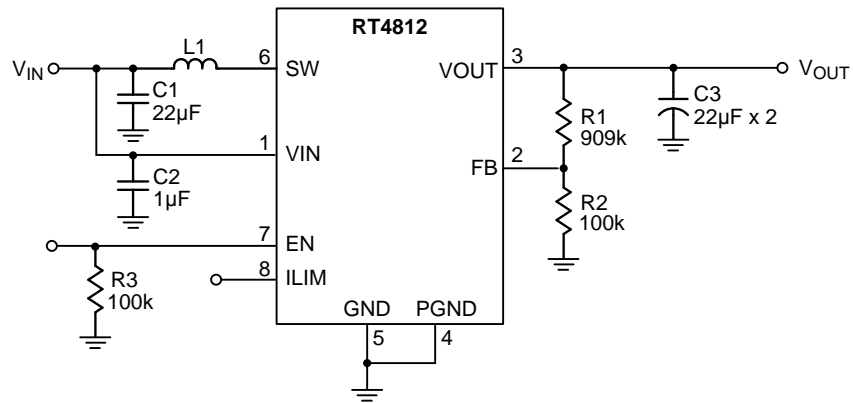

Typical Operating Characteristics

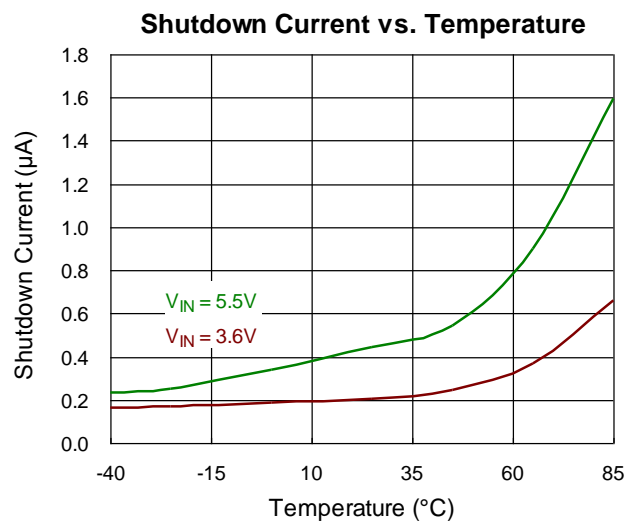
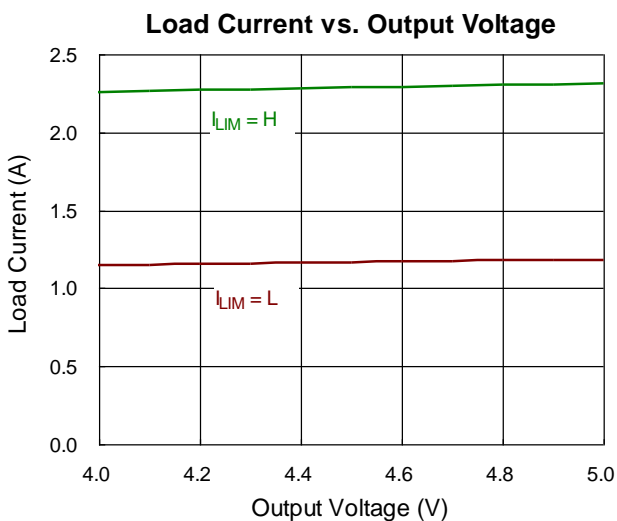
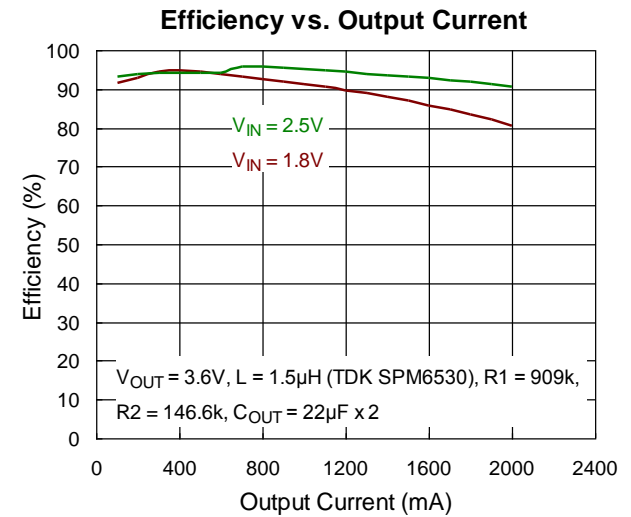
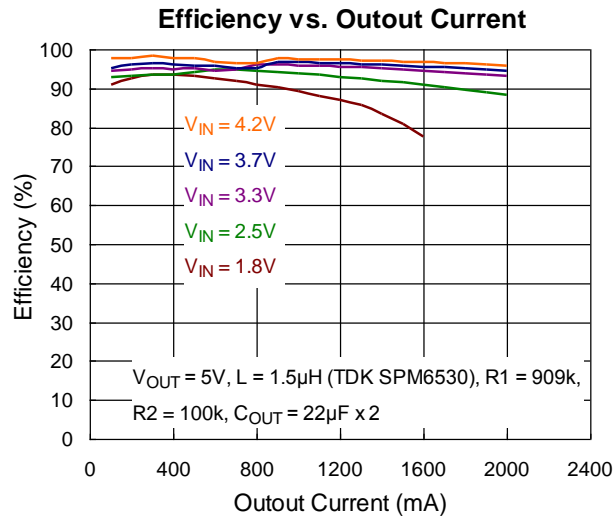
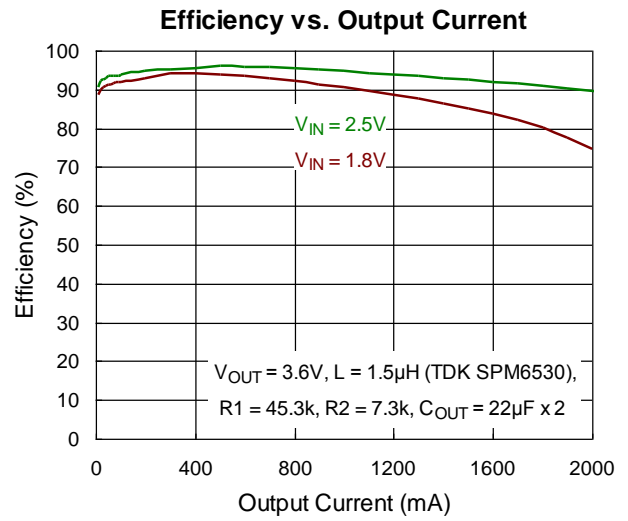
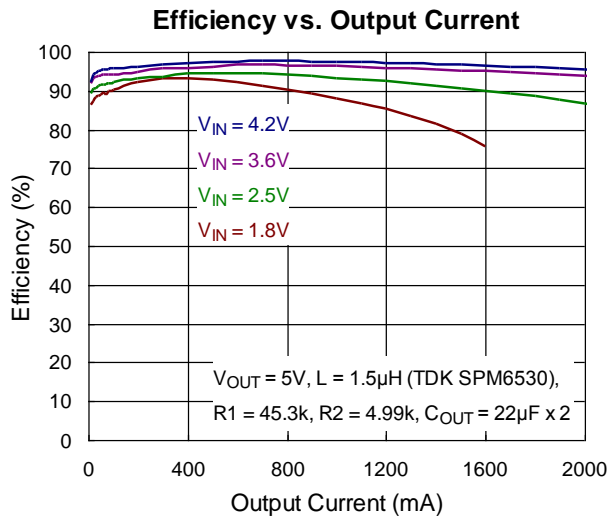



Output Voltage Ripple

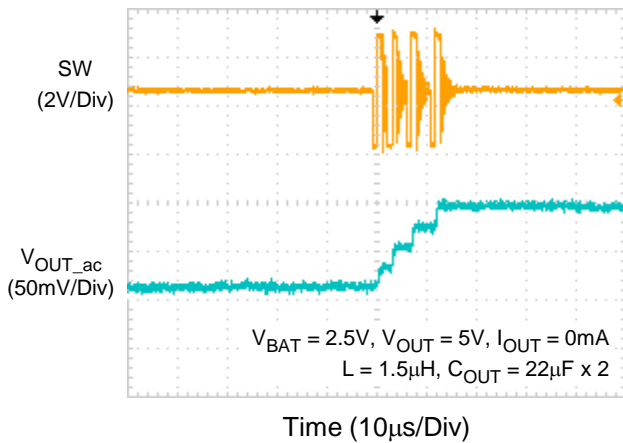

Output Voltage Ripple

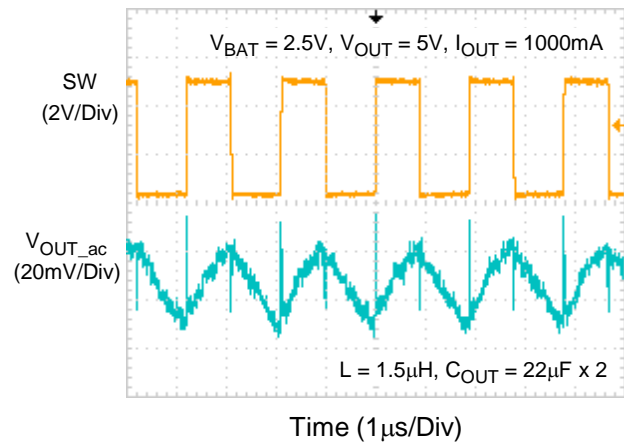

Output Voltage Ripple

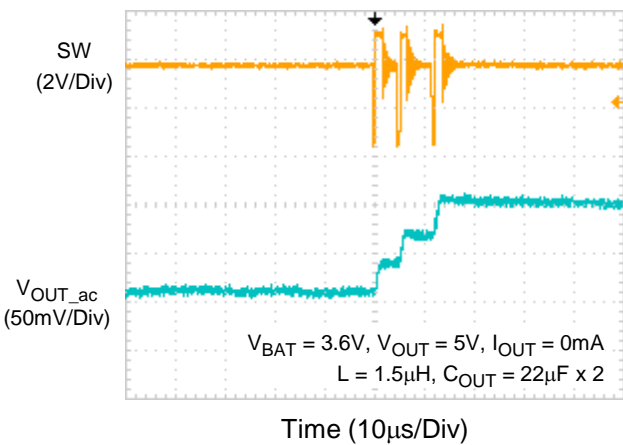

Output Voltage Ripple

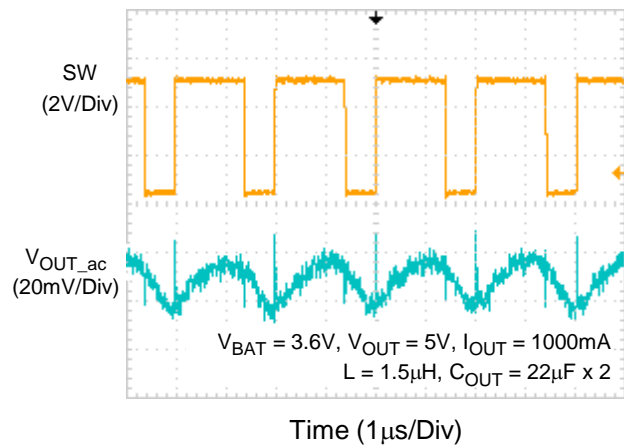

Output Voltage Ripple

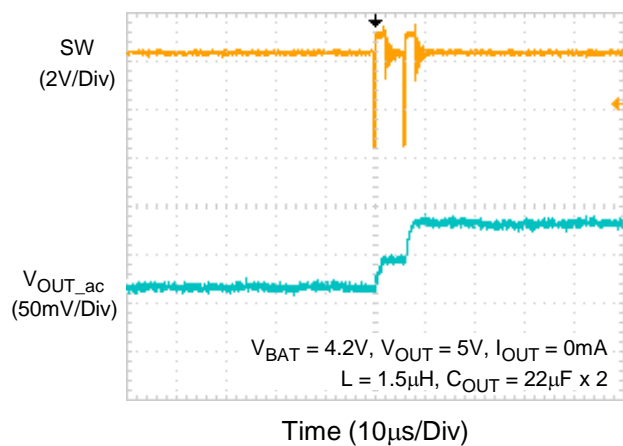

Output Voltage Ripple

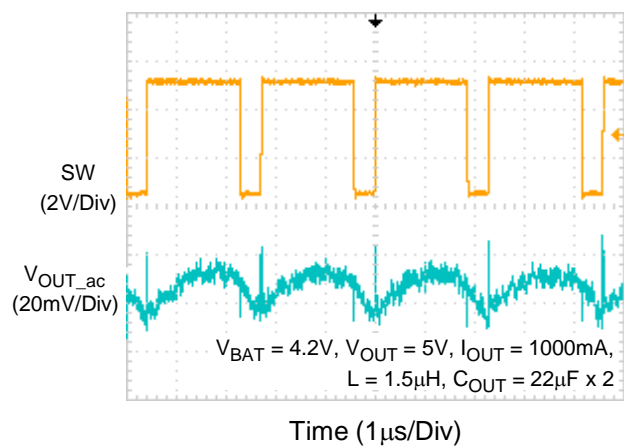

Load Transient Response

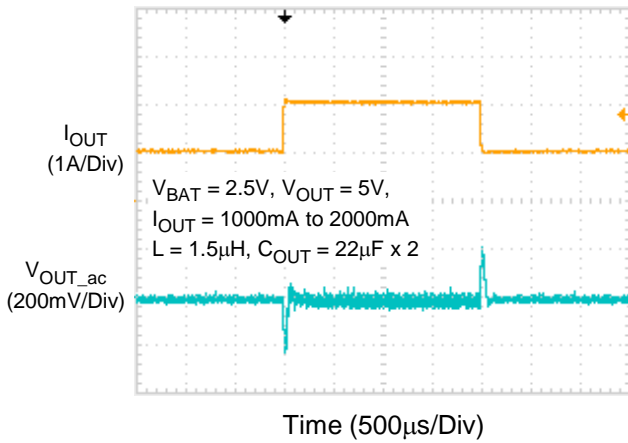

Load Transient Response

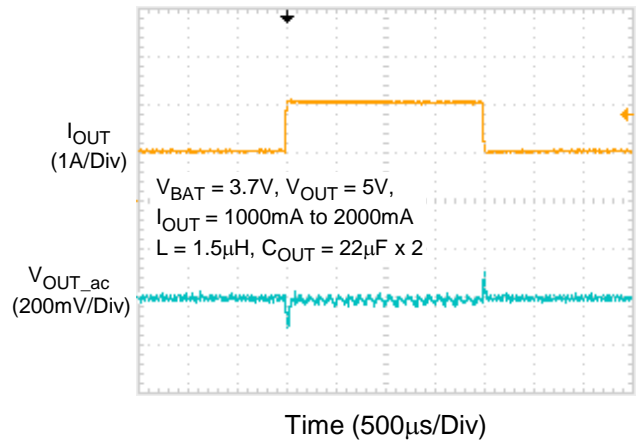

Load Transient Response

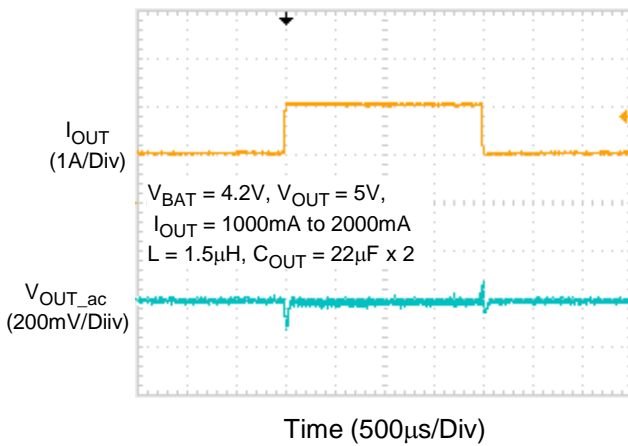

## Application Information

### Enable

The device can be enabled or disabled by the EN pin. When the EN pin is higher than the threshold of logic-high, the device starts operating with soft-start. Once the EN pin is set at low, the device will be shut down. In shutdown mode, the converter stops switching, internal control circuitry is turned off, and the load is disconnected from the input. This also means that the output voltage can drop below the input voltage during shutdown.

### Soft-Start State

After the successful completion of the LIN state ( $V_{OUT} \geq V_{IN} = 300mV$ ), the regulator begins switching with boost valley-current limited value 3500mA.

During Soft-Start state,  $V_{OUT}$  is ramped up by Boost internal loop. If  $V_{OUT}$  fails to reach target value during the Soft-Start period for more than 2ms, a fault condition is declared.

### Output Voltage Setting

The output voltage is adjustable by an external resistive divider. The resistive divider must be connected between  $V_{OUT}$ , FB and GND. When the output voltage is regulated properly, the typical value of the voltage at the FB pin is 500mV. Output voltage can be calculated by equation as below :

$$R1 = R2 \times \left( \frac{V_{OUT}}{V_{FB}} - 1 \right)$$

### Power Save Mode

PSM is the way to improve efficiency at light load.

When the output voltage is lower than a set threshold voltage, the converter will operate in PSM.

It raises the output voltage with several pulses until the loop exits PSM.

### Under-Voltage Lockout

The under-voltage lockout circuit prevents the device from operating incorrectly at low input voltages. It prevents the converter from turning on the power switches under undefined conditions and prevents the battery from deep discharge.  $V_{IN}$  voltage must be greater than 1.65V to enable the converter. During operation, if  $V_{IN}$  voltage drops below 1.55V, the converter is disabled and waiting internal IC default parameter value ready until the supply exceeds the UVLO rising threshold. The RT4812 automatically restarts if the input voltage recovers to the input voltage UVLO high level.

### Thermal Shutdown

The device has a built-in temperature sensor which monitors the internal junction temperature. If the temperature exceeds the threshold, the device stops operating. As soon as the IC temperature has decreased below the threshold with a hysteresis, it starts operating again. The built-in hysteresis is designed to avoid unstable operation at IC temperatures near the over temperature threshold.

### Inductor Selection

The recommended nominal inductance value is 1.5μH

It is recommended to use inductor with dc saturation current  $\geq 5000mA$

**Table 1. List of Inductors**

Manufacturer	Series	Dimensions (in mm)	Saturation Current (mA)
TDK	SPM6530T	7.1 x 6.5 x 3.0	11500
Taiyo Yuden	NRS5040T	5.15 x 5.15 x 4.2	6400

### Input Capacitor Selection

At least a 22μF and the rate voltage is 16V for DC bias input capacitor is recommended to improve transient behavior of the regulator and EMI behavior of the total power supply circuit for SW. And at least a 1μF ceramic capacitor placed as close as possible to the VIN and GND pins of the IC is recommended.

### Output Capacitor Selection

At least 22μF x 2 capacitors is recommended to improve VOUT ripple.

Output voltage ripple is inversely proportional to COUT.

Output capacitor is selected according to output ripple which is calculated as :

$$V_{\text{RIPPLE(P-P)}} = t_{\text{ON}} \times \frac{I_{\text{LOAD}}}{C_{\text{OUT}}}$$

and

$$t_{\text{ON}} = t_{\text{SW}} \times D = t_{\text{SW}} \times \left(1 - \frac{V_{\text{IN}}}{V_{\text{OUT}}}\right)$$

therefore :

$$C_{\text{OUT}} = t_{\text{SW}} \times \left(1 - \frac{V_{\text{IN}}}{V_{\text{OUT}}}\right) \times \frac{I_{\text{LOAD}}}{V_{\text{RIPPLE(P-P)}}$$

and

$$t_{\text{SW}} = \frac{1}{f_{\text{SW}}}$$

The maximum VRIPPLE occurs at minimum input voltage and maximum output load.

### Output Discharge Function

With the EN pin set to low, the VOUT pin is internally connected to GND for 10ms by an internal discharge N-MOSFET switch. After the 10ms, IC will be true-shut down.

This feature prevents residual charge voltages on capacitor connected to VOUT pins, which may impact proper power up of the system.

### Valley Current Limit

The RT4812 employs a valley-current limit detection scheme to sense inductor current during the off-time. When the loading current is increased such that the loading is above the valley current limit threshold, the off-time is increased until the current is decreased to valley-current threshold. Next on-time begins after current is decreased to valley-current threshold. On-time is decided by (VOUT – VIN) / VOUT ratio. The output voltage decreases when further loading current increase. The current limit function is implemented by the scheme, refer to Figure 3.

### Average Output Current Limit

The RT4812 features the average output current limit to protect the output terminal. When the load current is over the limit, output current will be clamped.

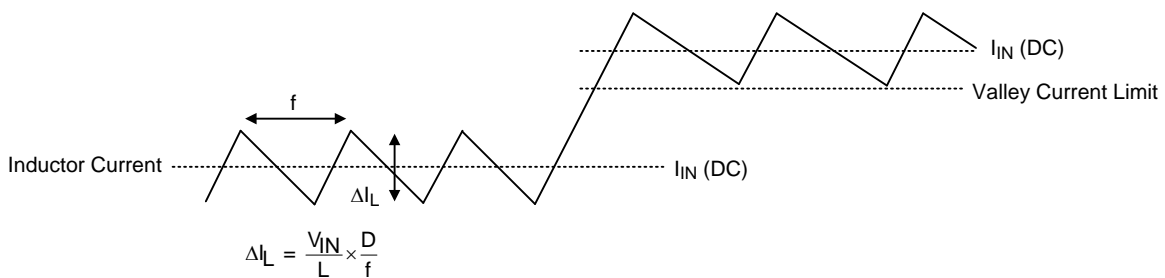

Figure 3. Inductor Currents In Current Limit Operation

Table 2. List of Capacitor

Reference	Qty.	Part Number	Description	Package	Manufacturer
CIN	1	GRM21BR61C226ME44	22μF / 16V / X5R	0805	MuRata
COUT	2	GRM21BR61C226ME44	22μF / 16V / X5R	0805	MuRata

**Thermal Considerations**

For continuous operation, do not exceed absolute maximum junction temperature. The maximum power dissipation depends on the thermal resistance of the IC package, PCB layout, rate of surrounding airflow, and difference between junction and ambient temperature. The maximum power dissipation can be calculated by the following formula :

$$P_{D(MAX)} = (T_{J(MAX)} - T_A) / \theta_{JA}$$

where  $T_{J(MAX)}$  is the maximum junction temperature,  $T_A$  is the ambient temperature, and  $\theta_{JA}$  is the junction to ambient thermal resistance.

For recommended operating condition specifications, the maximum junction temperature is 125°C. The junction to ambient thermal resistance,  $\theta_{JA}$ , is layout dependent. For TSOT-23-8 (FC) package, the thermal resistance,  $\theta_{JA}$ , is 56°C/W on a standard two-layer EVB test board. The maximum power dissipation at  $T_A = 25^\circ\text{C}$  can be calculated by the following formula :

$$P_{D(MAX)} = (125^\circ\text{C} - 25^\circ\text{C}) / (56^\circ\text{C/W}) = 1.78\text{W for TSOT-23-8 (FC) package}$$

The maximum power dissipation depends on the operating ambient temperature for fixed  $T_{J(MAX)}$  and thermal resistance,  $\theta_{JA}$ . The derating curve in Figure 4 allows the designer to see the effect of rising ambient temperature on the maximum power dissipation.

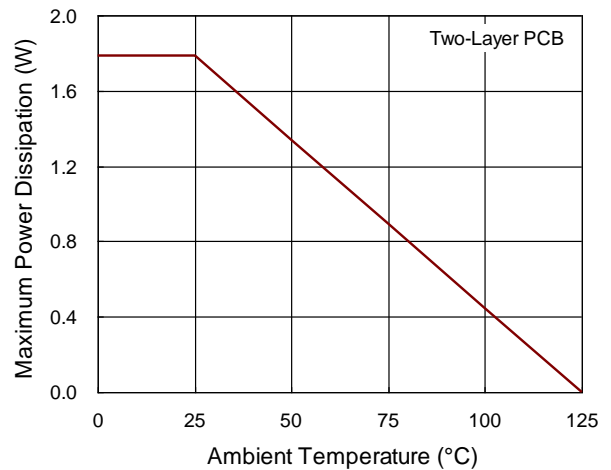

Figure 4. Derating Curve of Maximum Power Dissipation

**Layout Consideration**

The PCB layout is an important step to maintain the high performance of the RT4812.

Both the high current and the fast switching nodes demand full attention to the PCB layout to save the robustness of the RT4812 through the PCB layout. Improper layout might show the symptoms of poor line or load regulation, ground and output voltage shifts, stability issues, unsatisfying EMI behavior or worsened efficiency. For the best performance of the RT4812, the following PCB layout guidelines must be strictly followed.

- ▶ Input/Output capacitors must be placed as close as possible to the Input/Output pins.
- ▶ SW should be connected to Inductor by wide and short trace, keep sensitive components away from this trace.
- ▶ The feedback divider should be placed as close as possible to the FB pin.

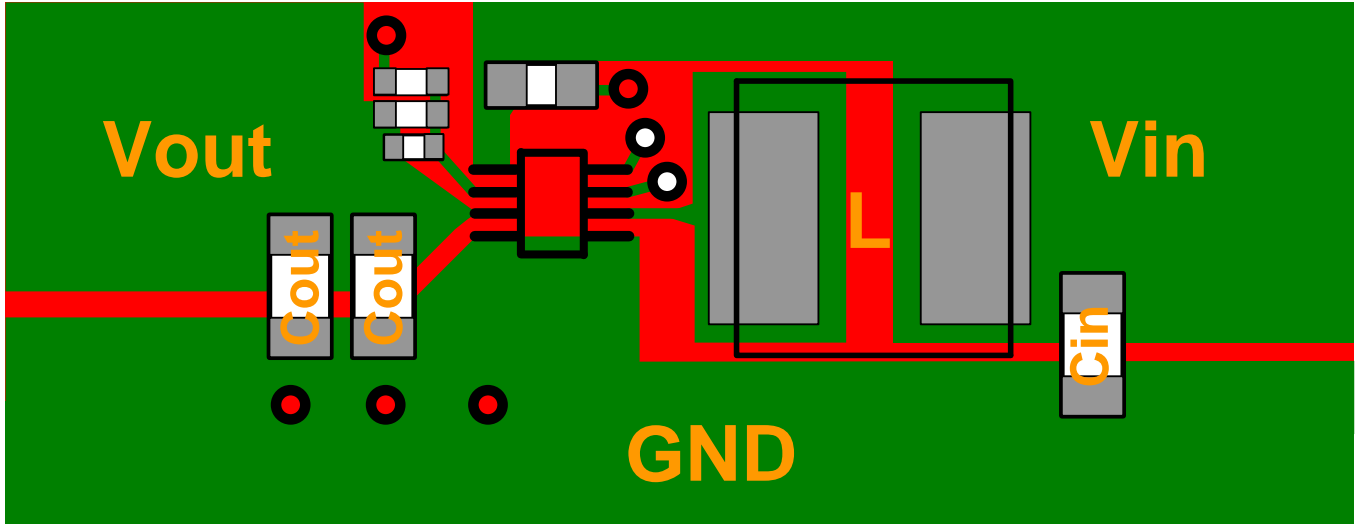
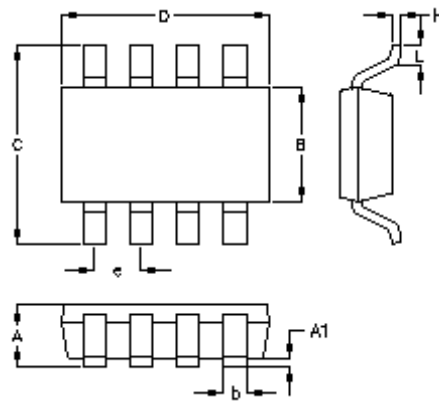

Figure 5. PCB Layout Guide

**Outline Dimension**



Symbol	Dimensions In Millimeters		Dimensions In Inches	
	Min	Max	Min	Max
A	0.700	1.000	0.028	0.039
A1	0.000	0.100	0.000	0.004
B	1.397	1.803	0.055	0.071
b	0.220	0.380	0.009	0.015
C	2.591	3.000	0.102	0.118
D	2.692	3.099	0.106	0.122
e	0.585	0.715	0.023	0.028
H	0.080	0.254	0.003	0.010
L	0.300	0.610	0.012	0.024

**TSOT-23-8 (FC) Surface Mount Package**

**Richtek Technology Corporation**

14F, No. 8, Tai Yuen 1<sup>st</sup> Street, Chupei City  
 Hsinchu, Taiwan, R.O.C.  
 Tel: (8863)5526789

**RICHTEK**

Richtek products are sold by description only. Richtek reserves the right to change the circuitry and/or specifications without notice at any time. Customers should obtain the latest relevant information and data sheets before placing orders and should verify that such information is current and complete. Richtek cannot assume responsibility for use of any circuitry other than circuitry entirely embodied in a Richtek product. Information furnished by Richtek is believed to be accurate and reliable. However, no responsibility is assumed by Richtek or its subsidiaries for its use; nor for any infringements of patents or other rights of third parties which may result from its use. No license is granted by implication or otherwise under any patent or patent rights of Richtek or its subsidiaries.

Copyright © 2022 Richtek Technology Corporation. All rights reserved. **RICHTEK** is a registered trademark of Richtek Technology Corporation.